



Expertise Applied | Answers Delivered

The top section of the cover features three distinct images of electronic components. On the left, there are several small, rectangular surface-mount components, some with green markings. In the center, there are five cylindrical components with a reddish-brown finish and two leads extending from the bottom. On the right, there are several larger, rectangular components with a metallic, silver-colored finish and two leads.

PRODUCT
CATALOG
& DESIGN
GUIDE

FUSE

Circuit Protection Products

Littelfuse Circuit Protection Solutions Portfolio

Consumer Electronics | Telecom | White Goods | Medical Equipment | TVSS and Power

DESIGN SUPPORT

Live Application Design and Technical Support—Tap into our expertise. Littelfuse engineers are available around the world to help you address design challenges and develop unique, customized solutions for your products.

Product Sampling Programs—Most of our products are available as samples for testing and verification within your circuit design. Visit Littelfuse.com or contact a Littelfuse product representative for additional information.

Product Evaluation Labs and Services—Littelfuse global labs are the hub of our new product development initiatives, and also provide design and compliance support testing as an added-value to our customers.



OVERVOLTAGE SUPPRESSION TECHNOLOGIES (1-6)

1. TVS Diodes— Suppress overvoltage transients such as Electrical Fast Transients (EFT), inductive load switching and lightning in a wide variety of applications in the computer, industrial, telecom and automotive markets.

2. Varistors— Multiple forms, from Metal Oxide Varistors (MOVs) that suppress transient voltages to Multi-Layer Varistors (MLVs) designed for applications requiring protection from various transients in computers and handheld devices as well as industrial and automotive applications.

3. SIDACTor® Devices— Complete line of protection thyristor products specifically designed to suppress overvoltage transients in a broad range of telecom and datacom applications.

4. Gas Plasma Arrestors (GDTs)— Available in small footprint leaded and surface mount configurations, Littelfuse GDTs respond fast to transient overvoltage events, reducing the risk of equipment damage.

5. SPA™ Silicon Protection Arrays— Designed specifically to protect analog and digital signal lines from electrostatic discharge (ESD) and other overvoltage transients.

6. PulseGuard® ESD Suppressors— Available in various surface mount form factors to protect high-speed digital lines without causing signal distortion.

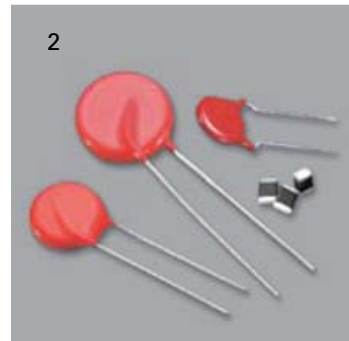
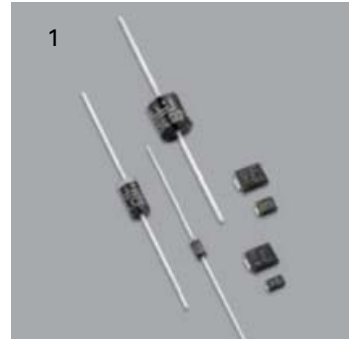

Visit

tection folio

Supplies | Lighting | General Electronics

SWITCHING TECHNOLOGIES

Switching Thyristors—
Solid-state switches used to control the flow of electrical current in applications, capable of withstanding rated blocking/off-state voltage until triggered to on-state.

ACCESSORIES

In addition to our broad portfolio of circuit protection technologies, we offer an array of **fuse holders** including circuit board, panel or in-line wire mounted devices to support a wide range of application requirements.

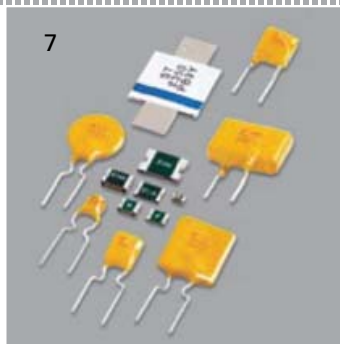
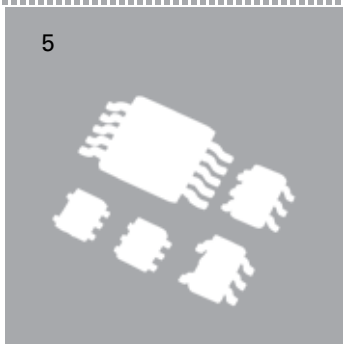
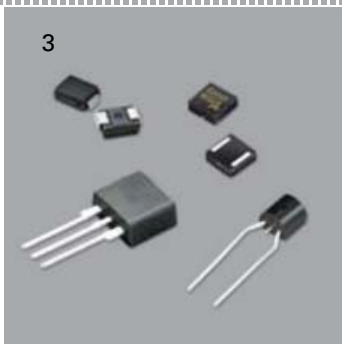

OVERCURRENT PROTECTION TECHNOLOGIES (7-8)

7. Positive Temperature Coefficient Devices (PTCs)—
Provide resettable overcurrent protection for a wide range of applications.

8. Fuses— Full range including surface mount, axial, glass or ceramic, thin-film or Nano² style, fast-acting or SloBlo[®], MINI[®] and ATO[®] fuses.

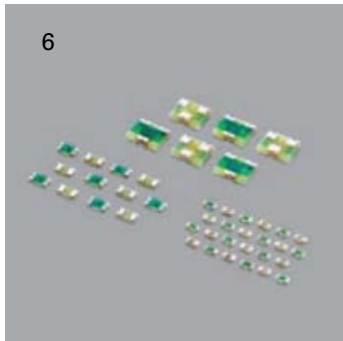
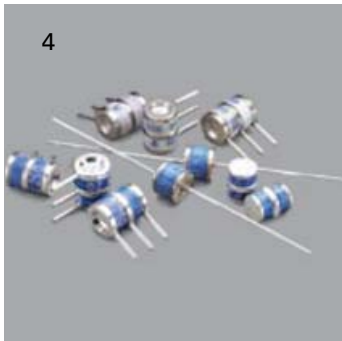

www.littelfuse.com for more information.









Fuses

As the #1 circuit protection company in the world Littelfuse offers the largest selection of fuses available, including surface mount, axial, glass or ceramic, thin-film or Nano²® style, fast-acting or SloBlo[®], MINI[®] and ATO[®] fuses.

In fact, many of our fuse products are the industry standard. Companies across the globe rely on Littelfuse circuit protection solutions to enhance the safety and reliability of their products, safeguard sensitive circuits and protect critical business assets.

From popular consumer electronic devices like MP3 players, mobile phones and digital cameras, to home appliances, telecom infrastructure equipment and critical life saving medical equipment, Littelfuse has the right fuse product for virtually any application.

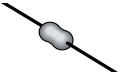
TABLE OF CONTENTS

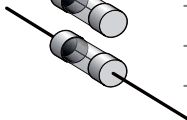
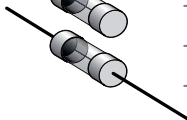
Introduction		
	Detailed Data Sheet Indexes	2-5
	Fuse Characteristics, Terms and Consideration Factors	6-8
	Fuse Selection Guide	9-11
	Standards	12-14
	Littelfuse Fuse Part Numbering System	15
Data Sheets: Surface Mount Fuses		
	Low Profile Ceramic and SlimLine™ Surface Mount Fuses	17-48
	Nano® Type Surface Mount Fuses and Fuseholder Assemblies	49-106
	459/460 PICO® SMF, 202/203 FLAT-PAK® and 446/467 EBF Surface Mount / Thru-Hole Fuses	107-126
Data Sheets: Radial Lead Fuses		
	Micro and TR-3 Fuses	127-137
	TR-5 Fuses	137-162
	TE-5 Fuses	163-198
Data Sheets: Axial Lead and Cartridge Fuses		
	PICO® / PICO II® Axial Lead Fuses	199-230
	3.6 x 10 mm Axial Lead Fuses	231-246
	4.5 x 14.5 mm (2AG) Axial Lead & Cartridge Fuses	247-264
	5 x 20 mm Axial Lead & Cartridge Fuses	265-312
	6.3 x 32 mm (3AG/3AB) Axial Lead & Cartridge Fuses	313-340
Data Sheets: Special Application Fuses		
	242 Series Barrier Network Fuse, 259 Series Safe-T-Plus Fuse and 481/482 Alarm Indicating Fuse and Fuseholder	341-348

Introduction

Surface Mount

Radial Lead

 Axial Lead /
Cartridge

 Special
Application

For information about Littelfuse fuseholders, automotive fuses and larger industrial fuses, please visit www.littelfuse.com/catalogs























Data Sheet Index: Organized By Fuse Series

Series #	Page #	Series #	Page #	Series #	Page #	Series #	Page #
154	93	259	343	369	163	453	57
154T	93	262	127	370	139	454	61
157	95	263	207	372	143	456	65
157T	99	265	223	373	147	458	69
159	103	266	223	374	151	459	107
202	115	267	223	382	155	460	111
203	119	268	127	383	159	461	85
208	247	269	127	385	167	461E	89
209	251	272	131	388	333	464	77
213	273	273	131	391	171	465	81
215	285	274	131	392	175	466	29
216	281	275	203	395	179	467	41
217	265	276	203	396	183	468	37
218	269	278	131	397	187	471	211
219XA	277	279	131	398	191	472	215
224	255	303	135	399	195	473	219
225	255	312	313	429	33	477	309
229	259	313	317	435	45	481	345
230	259	314	321	437	17	482	347
232	289	315	317	438	21	501	25
233	297	316	227	443	73	505	337
234	301	318	313	446	123	874	231
235	293	322	325	447	123	875	235
239	305	324	321	448	49	876	239
242	341	325	329	449	53	877	243
251	199	326	329	451	57		
253	199	332	325	452	61		

To view current information about Littelfuse product series, visit

[http://www.Littelfuse.com/Series/\(Series #\).html](http://www.Littelfuse.com/Series/(Series #).html)

Data Sheet Index: Organized By Fuse Type and Size



Surface Mount Fuses		
Low Profile Ceramic High Temperature Surface Mount Fuses		
RoHS  	437 series, 1206 Size, High Temperature, Fast-Acting, Lead-Free	17
RoHS  	438 series, 0603 Size, High Temperature, Fast-Acting, Lead-Free	21
RoHS  	501 series, 1206 Size, High Temperature, Fast-Acting, Lead-Free, High Current	25
Low Profile SlimLine™ Thin-Film Surface Mount Fuses		
RoHS 	466 series, SlimLine™ 1206 Size, Very Fast-Acting, Lead-Free	29
RoHS 	429 series, SlimLine™ 1206 Size, High Current Very Fast-Acting, Lead-Free	33
RoHS 	468 series, SlimLine™ 1206 Size, Slo-Blo®, Lead-Free	37
RoHS 	467 series, SlimLine™ 0603 Size, Very Fast-Acting, Lead-Free	41
RoHS 	435 series, SlimLine™ 0402 Size, Very Fast-Acting, Lead-Free	45
NANO²® Surface Mount Fuses		
RoHS	448 series, NANO ² ® Very Fast-Acting, Lead-Free	49
RoHS	449 series, NANO ² ® Slo-Blo®, Lead-Free	53
RoHS	451/453 series, NANO ² ® Very Fast-Acting	57
RoHS	452/454 series, NANO ² ® Slo-Blo®	61
RoHS  	456 series, NANO ² ®	65
RoHS  	458 series, NANO ² ®	69
RoHS  	443 series, NANO ² ® 250V Time-Lag	73
RoHS	464 series, NANO ² ® 250V UMF Fast-Acting	77
RoHS	465 series, NANO ² ® 250V UMF Time-Lag	81
RoHS	461 series, TeleLink®	85
RoHS 	461E series, Enhanced TeleLink®	89
RoHS 	154/154T series, NANO ² ® OMNI-BLOK® Fuse and Holder	93
RoHS 	157 series, NANO ² ® OMNI-BLOK® Fuse and Holder	95
RoHS 	157T series, NANO ² ® OMNI-BLOK® Fuse and Holder	99
RoHS 	159 series, NANO ² ® OMNI-BLOK® Fuse and Holder	103
Other (Leaded surface mount and through hole fuses)		
	459 series, PICO® leaded surface mount fuse	107
	460 series, PICO® leaded surface mount fuse	111
	202 series, FLAT-PAK® leaded surface mount fuse, Fast-Acting	115
	203 series, FLAT-PAK® leaded surface mount fuse, Slo-Blo®	119
	446 series leaded surface mount fuse / 447 series leaded through hole fuse, Fast-Acting	123

> Section continued on next page.













Data Sheet Index: Organized By Fuse Type and Size (continued from previous page)

Radial Lead Fuses



















Micro / TR-3 Fuses

	262/268/269 Series, MICRO™ Very Fast-Acting Fuse (High-Reliability)	127
	272/273/274/278/279 Series, MICRO™ Very Fast-Acting Fuse	131
 	303 Series, TR-3®, 50A@125V, Fast-Acting	135

TR-5 Fuses









 	370 Series, TR-5®, 35A@250V, Fast-Acting	139
 	372 Series, TR-5®, 35A@250V, Time-Lag	143
 	373 Series, TR-5®, 50A@250V, Fast-Acting	147
 	374 Series, TR-5®, 50A@250V, Time-Lag	151
 	382 Series, TR-5®, 100A@250V, Time-Lag Extended Breaking Capacity	155
  	383 Series, TR-5®, 50A@300V, Time-Lag	159

TE-5 Fuses













  	369 Series, TE-5®, 50A@300V, Time-Lag	163
 	385 Series, TE-5®, 50A@125V, Time-Lag	167
 	391 Series, TE-5®, 50A@65V, Fast-Acting	171
 	392 Series, TE-5®, 25A@250V, Time-Lag	175
 	395 Series, TE-5®, 100A@125V, Fast-Acting	179
 	396 Series, TE-5®, 100A@ 125V, Time-Lag	183
 	397 Series, TE-5®, 50A@125V, Time-Lag	187
 	398 Series, TE-5®, 50A@65V, Medium Time-Lag	191
 	399 Series, TE-5®, 50A@65V, Time-Lag	195

Axial Lead and Cartridge Fuses

PICO® & PICO II® Axial Lead Fuses









	251/253 Series, PICO® II, Very Fast-Acting Fuse	199
	275/276 Series, PICO®, Very Fast-Acting Fuse	203
	263 Series, PICO® II 250 Volt, Very Fast-Acting Fuse	207
	471 Series, PICO® II, Time-Lag Fuse	211
	472 Series, PICO® II, Time-Lag Fuse	215
	473 Series, PICO® II, Slo-Blo® Fuse	219
	265/266/267 Series, PICO®, Very Fast-Acting Fuse (High-Reliability)	223
	316 Series, PICO® II, Very Fast-Acting Fuse	227

3.6 x 10 mm Cartridge and Axial Lead Fuses

  	874 Series, Fast-Acting	231
  	875 Series, Slo-Blo®	235
  	876 Series, Fast-Acting	239
  	877 Series, Slo-Blo®	243

> Section continued on next page.















Axial Lead and Cartridge Fuses *(Continued from previous page)*
4.5 x 14.5 mm (2AG) Cartridge and Axial Lead Fuses

 	208 Series, UL Standard, 350V, Fast-Acting	247
 	209 Series, UL Standard, 350V, Time-Lag	251
 	224/225 Series, UL Standard, Fast-Acting (Wider Amperage Range)	255
 	229/230 Series, UL Standard, Time-Lag (Wider Amperage Range)/Indicating	259

5 x 20 mm Cartridge and Axial Lead Fuses

 	217 Series, IEC Standard, Low Breaking Capacity (<100A, Glass), 250V Fast-Acting	265
 	218 Series, IEC Standard, Low Breaking Capacity (<100A, Glass), 250V Time-Lag	269
 	213 Series, IEC Standard, Low Breaking Capacity, (<100A, Glass), 250V Time-Lag, Surge Withstand	273
 	219XA Series, IEC Standard, Low Breaking Capacity, (<100A, Glass), 250V Time-Lag, High I ² t	277
 	216 Series, IEC Standard, 250V, High Braking Capacity, (1500A, Ceramic) Fast-Acting	281
 	215 Series, IEC Standard, 250V, High Braking Capacity (1500A, Ceramic) Time-Lag, Surge Withstand	285
 	232 Series, Japanese Standard, 250V, Medium-Acting	289
 	235 Series, UL Standard, 125V (10KA), Fast-Acting	293
 	233 Series, UL Standard, 125V (10KA), Medium-Acting	297
 	234 Series, UL Standard, 250V, Medium-Acting	301
 	239 Series, UL Standard, 125V (10KA) or 250V (<100A), Time-Lag	305
  	477 Series, IEC Standard, 400Vdc/500Vac, Time-Lag	309

6.3 x 32 mm (3AG/3AB) Cartridge and Axial Lead Fuses

 	312/318 Series, (UL Standard, Glass) Fast-Acting	313
 	313/315 Series, (UL Standard, Glass) Time-Lag	317
 	314/324 Series, (UL Standard, Ceramic, Higher Braking Capacity) Fast-Acting	321
 	322 Series, (UL Standard, Ceramic, Higher Breaking Capacity) Very Fast-Acting	325
 	325/326 Series, (UL Standard, Ceramic, Higher Breaking Capacity) Time-Lag	329
 	388 Series, (Glass) METI B Fuse	333
  	505 Series, (UL Standard, Ceramic) Fast-Acting	337

Special Application Fuses

	242 Series Barrier Network Fuse	341
	259 Series Safe-T-Plus Fuse	343
	481 Series Alarm Indicating Fuse	345
	482 Series Alarm Indicating Fuseholder	347

To view current information about Littelfuse product series, visit
[http://www.Littelfuse.com/Series/\(Series #\).html](http://www.Littelfuse.com/Series/(Series #).html)

Fuse Characteristics, Terms and Consideration Factors

The purpose of this introductory section is to promote a better understanding of both fuses and common application details within circuit design.

The fuses to be considered are current sensitive devices designed to serve as the intentional weak link in the electrical circuit. Their function is to provide protection of discrete components, or of complete circuits, by reliably melting under current overload conditions. This section will cover some important facts about fuses, selection considerations and standards.

The application guidelines and product data in this guide are intended to provide technical information that will help with application design. The fuse parameters and application concepts presented should be well understood in order to properly select a fuse for a given application.

Since these are only a few of the contributing parameters, application testing is strongly recommended and should be used to verify performance in the circuit / application.

Littelfuse reserves the right to make changes in product design, processes, manufacturing location and information without notice. For current Littelfuse product information, please visit our web site at www.littelfuse.com.

AMBIENT TEMPERATURE: Refers to the temperature of the air immediately surrounding the fuse and is not to be confused with "room temperature." The fuse ambient temperature is appreciably higher in many cases, because it is enclosed (as in a panel mount fuseholder) or mounted near other heat producing components, such as resistors, transformers, etc.

BREAKING CAPACITY: Also known as interrupting rating or short circuit rating, this is the maximum approved current which the fuse can safely break at rated voltage. Please refer to the interrupting rating definition of this section for additional information.

CURRENT RATING: The nominal amperage value of the fuse. It is established by the manufacturer as a value of current which the fuse can carry, based on a controlled set of test conditions (See RERATING).

Catalog Fuse part numbers include series identification and amperage ratings. Refer to the FUSE SELECTION GUIDE section for guidance on making the proper choice.

RERATING: For 25°C ambient temperatures, it is recommended that fuses be operated at no more than 75% of the nominal current rating established using the controlled test conditions. These test conditions are part of UL/CSA/ANCE (Mexico) 248-14 "Fuses for Supplementary Overcurrent Protection," whose primary objective is to specify common test standards necessary for the continued control of manufactured items intended for

protection against fire, etc. Some common variations of these standards include: fully enclosed fuseholders, high contact resistances, air movement, transient spikes, and changes in connecting cables size (diameter and length). Fuses are essentially temperature-sensitive devices. Even small variations from the controlled test conditions can greatly affect the predicted life of a fuse when it is loaded to its nominal value, usually expressed as 100% of rating.

The circuit design engineer should clearly understand that the purpose of these controlled test conditions is to enable fuse manufacturers to maintain unified performance standards for their products, and he must account for the variable conditions of his application. To compensate for these variables, the circuit design engineer who is designing for trouble-free, long-life fuse protection in his equipment generally loads his fuse not more than 75% of the nominal rating listed by the manufacturer, keeping in mind that overload and short circuit protection must be adequately provided for.

The fuses under discussion are temperature-sensitive devices whose ratings have been established in a 25°C ambient. The fuse temperature generated by the current passing through the fuse increases or decreases with ambient temperature change.

The ambient temperature chart in the FUSE SELECTION GUIDE section illustrates the effect that ambient temperature has on the nominal current rating of a fuse. Most traditional Slo-Blo[®] Fuse designs use lower melting temperature materials and are, therefore, more sensitive to ambient temperature changes.

DIMENSIONS: Unless otherwise specified, dimensions are in inches.

The fuses in this catalog range in size from the approx. 0402 chip size (.041" L x .020" W x .012" H) up to the 5 AG, also commonly known as a "MIDGET" fuse (13/32" Dia. x 11/2" Length). As new products were developed throughout the years, fuse sizes evolved to fill the various electrical circuit protection needs.

The first fuses were simple, open-wire devices, followed in the 1890's by Edison's enclosure of thin wire in a lamp base to make the first plug fuse. By 1904, Underwriters Laboratories had established size and rating specifications to meet safety standards. The renewable type fuses and automotive fuses appeared in 1914, and in 1927 Littelfuse started making very low amperage fuses for the budding electronics industry.

The fuse sizes in following chart began with the early "Automobile Glass" fuses, thus the term "AG." The numbers were applied chronologically as different manufacturers started making a new size: "3AG," for example, was the third size placed on the market. Other non-glass fuse sizes and constructions were determined by functional requirements, but they still retained the

length or diameter dimensions of the glass fuses. Their designation was modified to AB in place of AG, indicating that the outer tube was constructed from Bakelite, fibre, ceramic, or a similar material other than glass. The largest size fuse shown in the chart is the 5AG, or "MIDGET," a name adopted from its use by the electrical industry and the National Electrical Code range which normally recognizes fuses of 9/16" x 2" as the smallest standard fuse in use.

FUSE SIZES				
SIZE	DIAMETER (Inches)		LENGTH (Inches)	
1AG	1/4	.250	5/8	.625
2AG	—	.177	—	.588
3AG	1/4	.250	1 1/4	1.25
4AG	9/32	.281	1 1/4	1.25
5AG	13/32	.406	1 1/2	1.50
7AG	1/4	.250	7/8	.875
8AG	1/4	.250	1	1

TOLERANCES: The dimensions shown in this catalog are nominal. Unless otherwise specified, tolerances are applied as follows. Tolerances do not apply to lead lengths:

- ± .010" for dimensions to 2 decimal places.
- ± .005" for dimensions to 3 decimal places.

Contact Littelfuse should you have questions regarding metric system and fractional tolerances.

FUSE CHARACTERISTICS: This characteristic of a fuse design refers to how rapidly it responds to various current overloads. Fuse characteristics can be classified into three general categories: very fast-acting, fast-acting, or Slo-Blo® Fuse. The distinguishing feature of Slo-Blo® fuses is that these fuses have additional thermal inertia designed to tolerate normal initial or start-up overload pulses.

FUSE CONSTRUCTION: Internal construction may vary depending on ampere rating. Fuse photos in this catalog show typical construction of a particular ampere rating within the fuse series.

FUSEHOLDERS: In many applications, fuses are installed in fuseholders. These fuses and their associated fuseholders are not intended for operation as a "switch" for turning power "on" and "off".

INTERRUPTING RATING: Also known as breaking capacity or short circuit rating, the interrupting rating is the maximum approved current which the fuse can safely interrupt at rated voltage. During a fault or short circuit condition, a fuse may receive an instantaneous overload current many times greater than its normal operating current. Safe operation requires that the fuse remain intact (no explosion or body rupture) and clear the circuit.

Interrupting ratings may vary with fuse design and range from 35 amperes for some 250VAC metric size (5 x 20mm) fuses up to 200,000 amperes for the 600VAC KLK series.

Information on other fuse series can be obtained from the Littelfuse

Fuses listed in accordance with UL/CSA/ANCE 248 are required to have an interrupting rating of 10,000 amperes at 125V, with some exceptions (See STANDARDS section) which, in many applications, provides a safety factor far in excess of the short circuit currents available.

NUISANCE OPENING: Nuisance opening is most often caused by an incomplete analysis of the circuit under consideration.

Of all the "Selection Factors" listed in the FUSE SELECTION GUIDE, special attention must be given to items 1, 3, and 6, namely, normal operating current, ambient temperature, and pulses.

For example, one prevalent cause of nuisance opening in conventional power supplies is the failure to adequately consider the fuse's nominal melting I²t rating. The fuse cannot be selected solely on the basis of normal operating current and ambient temperature. In this application, the fuse's nominal melting I²t rating must also meet the inrush current requirements created by the input capacitor of the power supply's smoothing filter.

The procedure for converting various waveforms into I²t circuit demand is given in the FUSE SELECTION GUIDE. For trouble-free, long-life fuse protection, it is good design practice to select a fuse such that the I²t of the waveform is no more than 20% of the nominal melting I²t rating of the fuse. Refer to the section on PULSES in the FUSE SELECTION GUIDE.

RESISTANCE: The resistance of a fuse is usually an insignificant part of the total circuit resistance. Since the resistance of fractional amperage fuses can be several ohms, this fact should be considered when using them in low-voltage circuits. Actual values can be obtained by contacting Littelfuse.

Most fuses are manufactured from materials which have positive temperature coefficients, and, therefore, it is common to refer to cold resistance and hot resistance (voltage drop at rated current), with actual operation being somewhere in between.

Cold resistance is the resistance obtained using a measuring current of no more than 10% of the fuse's nominal rated current. Values shown in this publication for cold resistance are nominal and representative. The factory should be consulted if this parameter is critical to the design analysis.

Hot resistance is the resistance calculated from the stabilized voltage drop across the fuse, with current equal to the nominal rated current flowing through it. Resistance data on all Littelfuse products are available on request. Fuses can be supplied to specified controlled resistance tolerances at additional cost.

SOLDERING RECOMMENDATIONS: Since most fuse constructions incorporate soldered connections, caution should be used when installing those fuses intended to be soldered in place. The application of excessive heat can reflow the solder within the fuse and change its rating. Fuses are heat-sensitive components similar to semi-conductors, and the use of heat sinks during soldering is often recommended.

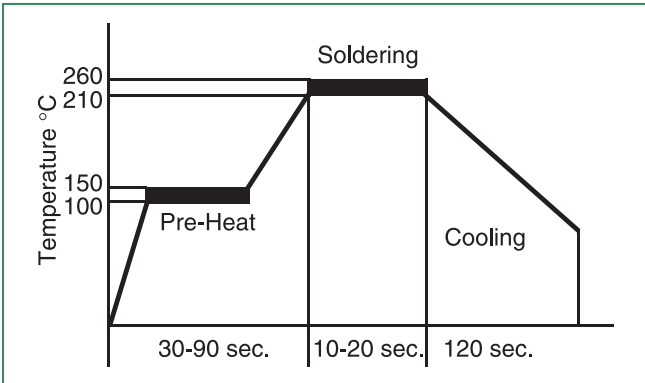

Lead-Free Soldering Parameters (most instances):

Wave Solder — 260°C, 10 seconds max
 Reflow Solder — 260°C, 30 seconds max

TEST SAMPLING PLAN: Because compliance with certain specifications requires destructive testing, these tests are selected on a statistical basis for each lot manufactured.

TIME-CURRENT CURVE: The graphical presentation of the fusing characteristic, time-current curves are generally average curves which are presented as a design aid but are not generally considered part of the fuse specification. Time-current curves are extremely useful in defining a fuse, since fuses with the same current rating can be represented by considerably different time-current curves. The fuse specification typically will include a life requirement at 100% of rating and maximum opening times at overload points (usually 135% and 200% of rating depending on fuse standard characteristics). A time-current curve represents average data for the design; however, there may be some differences in the values for any one given production lot. Samples should be tested to verify performance, once the fuse has been selected.

UNDERWRITERS LABORATORIES: Reference to “Listed by Underwriters Laboratories” signifies that the fuses meet the requirements of UL/CSA/ANCE 248-14 “Fuses for Supplementary Overcurrent Protection”. Some 32 volt fuses (automotive) in this catalog are listed under UL Standard 275. Reference to “Recognized under the Component Program of Underwriters Laboratories” signifies that the item is recognized under the component program of Underwriters Laboratories and application approval is required.

VOLTAGE RATING: The voltage rating, as marked on a fuse, indicates that the fuse can be relied upon to safely interrupt its rated short circuit current in a circuit where the voltage is equal to, or less than, its rated voltage.

This system of voltage rating is covered by N.E.C. regulations and is a requirement of Underwriters Laboratories as a protection against fire risk. The standard voltage ratings used by fuse manufacturers for most small-dimension and midget fuses are 32, 63, 125, 250 and 600.

In electronic equipment with relatively low output power supplies, with circuit impedance limiting short circuit currents to values of less than ten times the current rating of the fuse, it is common practice to specify fuses with 125 or 250 volt ratings for secondary circuit protection of 500 volts or higher.

As mentioned previously (See RERATING), fuses are sensitive to changes in current, not voltage, maintaining their “status quo” at any voltage up to the maximum rating of the fuse. It is not until the fuse element melts and arcing occurs that the circuit voltage and available power become an issue. The safe interruption of the circuit, as it relates to circuit voltage and available power, is discussed in the section on INTERRUPTING RATING.

To summarize, a fuse may be used at any voltage that is less than its voltage rating without detriment to its fusing characteristics. Please contact the factory for applications at voltages greater than the voltage rating.

DERIVATION OF NOMINAL MELTING I²t: Laboratory tests are conducted on each fuse design to determine the amount of energy required to melt the fusing element. This energy is described as nominal melting I²t and is expressed as “Ampere Squared Seconds” (A² Sec.).

A pulse of current is applied to the fuse, and a time measurement is taken for melting to occur. If melting does not occur within a short duration of about 8 milliseconds (0.008 seconds) or less, the level of pulse current is increased. This test procedure is repeated until melting of the fuse element is confined to within about 8 milliseconds.

The purpose of this procedure is to assure that the heat created has insufficient time to thermally conduct away from the fuse element. That is, all of the heat energy (I²t) is used, to cause melting. Once the measurements of current (I) and time (t) are determined, it is a simple matter to calculate melting I²t. When the melting phase reaches completion, an electrical arc occurs immediately prior to the “opening” of the fuse element.

$$\text{Clearing } I^2t = \text{Melting } I^2t + \text{arcing } I^2t$$

The nominal I²t values given in this publication pertain to the melting phase portion of the “clearing” or “opening”. Alternatively the time can be measured at 10 times of the rated current and the I²t value is calculated like above.

Fuse Selection Guide

The application guidelines and product data in this guide are intended to provide technical information that will help with application design. Since these are only a few of the contributing parameters, application testing is strongly recommended and should be used to verify performance in the circuit/application.

Many of the factors involved with fuse selection are listed below. For additional assistance with choosing fuses appropriate to your requirements, contact your Littelfuse products representative.:

Selection Factors

1. Normal operating current
2. Application voltage (AC or DC)
3. Ambient temperature
4. Overload current and length of time in which the fuse must open
5. Maximum available fault current
6. Pulses, Surge Currents, Inrush Currents, Start-up Currents, and Circuit Transients
7. Physical size limitations, such as length, diameter, or height
8. Agency Approvals required, such as UL, CSA, VDE, METI, MITI or Military
9. Fuse features (mounting type/form factor, ease of removal, axial leads, visual indication, etc.)
10. Fuseholder features, if applicable and associated rerating (clips, mounting block, panel mount, PC board mount, R.F.I. shielded, etc.)
11. Application testing and verification prior to production

1. NORMAL OPERATING CURRENT: The current rating of a fuse is typically derated 25% for operation at 25°C to avoid nuisance blowing. For example, a fuse with a current rating of 10A is not usually recommended for operation at more than 7.5A in a 25°C ambient. For additional details, see RERATING in the previous section and AMBIENT TEMPERATURE below.

2. APPLICATION VOLTAGE: The voltage rating of the fuse must be equal to, or greater than, the available circuit voltage. For exceptions, see VOLTAGE RATING.

3. AMBIENT TEMPERATURE: The current carrying capacity tests of fuses are performed at 25°C and will be affected by changes in ambient temperature. The higher the ambient temperature, the hotter the fuse will operate, and the shorter its life. Conversely, operating at a lower temperature will prolong fuse life. A fuse also runs hotter as the normal operating current approaches or exceeds the rating of the selected fuse. Practical experience indicates fuses at **room temperature** should last indefinitely, if operated at no more than 75% of catalog fuse rating.

Ambient temperature effects are in addition to the normal re-rating, see example. Example: Given a normal operating current of 2.25 amperes in an application using a 229 series fuse at room temperature, then:

$$\text{Catalog Fuse Rating} = \frac{\text{Normal Operating Current}}{0.75}$$

- or -

$$\frac{2.25 \text{ Amperes}}{0.75} = 3 \text{ Amp Fuse (at 25°C)}$$

This chart shows typical ambient temperature effects on current carrying capacity of Littelfuse products. For specific re-rating information, please consult the product data sheet (www.littelfuse.com) or contact a Littelfuse representative.

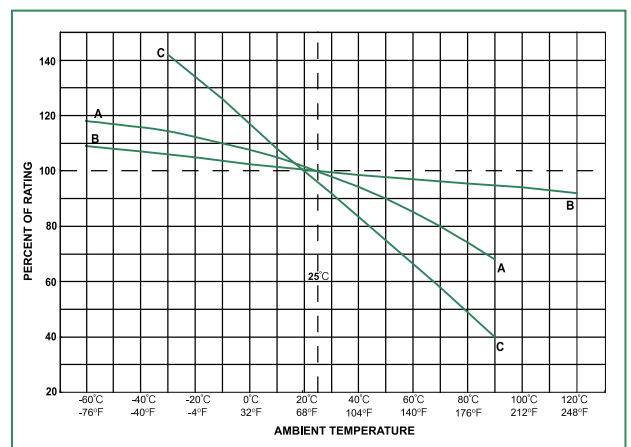

Curve A: Thin-Film Fuses and 313 Series (.010 to .150A)

Curve B: FLAT-PAK®, TeleLink®, Nano2®, PICO®, Blade Terminal and other leaded and cartridge fuses

Curve C: Resettable PTC's

4. OVERLOAD CURRENT CONDITION: The current level for which protection is required. Fault conditions may be specified, either in terms of current or, in terms of both current and maximum time the fault can be tolerated before damage occurs. Time-current curves should be consulted to try to match the fuse characteristic to the circuit needs, while keeping in mind that the curves are based on average data.

5. MAXIMUM FAULT CURRENT: The Interrupting Rating of a fuse must meet or exceed the Maximum Fault Current of the circuit.

6. PULSES: The general term “pulses” is used in this context to describe the broad category of wave shapes referred to as “surge currents,” “start-up currents,” “inrush currents,” and “transients.” Electrical pulse conditions can vary considerably from one application to another. Different fuse constructions may not react the same to a given pulse condition. Electrical pulses produce thermal cycling and possible mechanical fatigue that could affect the life of the fuse. Initial or start-up pulses are normal for some applications and require the characteristic of a Slo-Blo® fuse. Slo-Blo® fuses incorporate a thermal delay design to enable them to survive normal start-up pulses and still provide protection against prolonged overloads. The start-up pulse should be defined and then compared to the time-current curve and I²t rating for the fuse. Application testing is recommended to establish the ability of the fuse design to withstand the pulse conditions.

Nominal melting I²t is a measure of the energy required to melt the fusing element and is expressed as “Ampere Squared Seconds” (A² Sec.). This nominal melting I²t, and the energy it represents (within a time duration of 8 milliseconds [0.008 second] or less and 1 millisecond [0.001 second] or less for thin film fuses), is a value that is constant for each different fusing element. Because every fuse type and rating, as well as its corresponding part number, has a different fusing element, it is necessary to determine the I²t for each. This I²t value is a parameter of the fuse itself and is controlled by the element material and the configuration of the fuse element. In addition to selecting fuses on the basis of “Normal Operating Currents,” “Derating,” and “Ambient Temperature” as discussed earlier, it is also necessary to apply the I²t design approach. This nominal melting I²t is not only a constant value for each fuse element design, but it is also independent of temperature and voltage. Most often, the nominal melting I²t method of fuse selection is applied to those applications in which the fuse must sustain large current pulses of a short duration. These high-energy currents are common in many applications and are critical to the design analysis.

The following example should assist in providing a better understanding of the application of I²t.

EXAMPLE: Select a 125V, very fast-acting PICO®II fuse that is capable of withstanding 100,000 pulses of current (I) of the pulse waveform shown in Figure 1.

The normal operating current is 0.75 ampere at an ambient temperature of 25°C.

Step 1 — Refer to Chart 1 and select the appropriate pulse waveform, which is waveform (E) in this example. Place the applicable value for peak pulse current (i_p) and time (t) into the corresponding formula for waveshape (E), and calculate the result, as shown:

$$I^2t = \frac{1}{5} (i_p)^2 t = \frac{1}{5} (i_p)^2 t$$

$$\frac{1}{5} \times 8^2 \times .004 = 0.0512 \text{ A}^2 \text{ Sec.}$$

This value is referred to as the “Pulse I²t”

Step 2 — Determine the required value of Nominal Melting I²t by referring to Chart 2. A figure of 22% is shown in Chart II for 100,000 occurrences of the Pulse I²t calculated in Step 1. This Pulse I²t is converted to its required value of Nominal Melting I²t as follows:

$$\text{Nom. Melt } I^2t = \text{Pulse } I^2t / .22$$

$$0.0512 / .22 = 0.2327 \text{ A}^2 \text{ Sec.}$$

Step 3 — Examine the I²t rating data for the PICO® II, 125V, very fast-acting fuse. The part number 251001, 1 ampere design is rated at 0.256 A² Sec., which is the minimum fuse rating that will accommodate the 0.2327 A² Sec. value calculated in Step 2. This 1 ampere fuse will also accommodate the specified 0.75 ampere normal operating current, when a 25% derating factor is applied to the 1 ampere rating, as previously described.

7. PHYSICAL SIZE LIMITATIONS: Please refer to the product dimensions presented in current Littelfuse product data sheets for specific information.

8. AGENCY APPROVALS: For background information about common standards, please consult the STANDARDS section of this guide or visit our Design Support web site (<http://www.littelfuse.com/design-support.html>). For specific agency approval information for each Littelfuse product, please refer to the data sheets within this catalog and information presented on www.littelfuse.com. As agency approvals and standards may change, please rely on the information presented on www.littelfuse.com as current information.

9. FUSE FEATURES: Please consult the specific product features presented within this catalog and on our web site (<http://www.littelfuse.com>). For additional information and support contact your Littelfuse product representative.

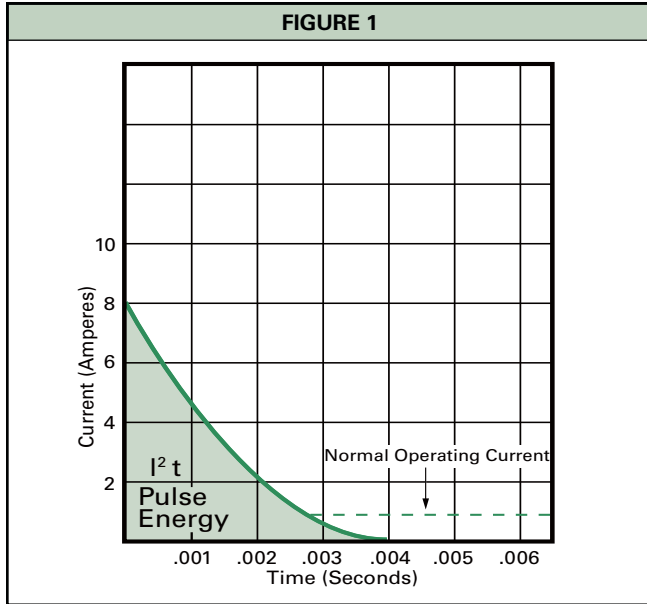

10. FUSEHOLDER FEATURES AND RERATING: For information about the range of Littelfuse fuseholders and specific features and characteristics, please consult with a Littelfuse products representative or visit our web site (<http://www.littelfuse.com>).

For 25°C ambient temperatures, it is recommended that fuseholders be operated at no more than 60% of the nominal current rating established using the controlled test conditions specified by Underwriters Laboratories. The primary objective of these UL test conditions is to specify common test standards necessary for the continued control of manufactured items intended for protection against fire, etc. A copper dummy fuse is inserted in the fuseholder by Underwriters Laboratories, and then the current is increased until a certain temperature rise occurs. The majority of the heat is produced by the contact resistance of the fuseholder clips. This value of current is considered to be the rated current of the fuseholder, expressed as 100% of rating. Some of the more common, everyday applications may differ from these UL test conditions as follows: fully enclosed fuseholders, high contact resistance, air movement, transient spikes, and changes in connecting cable size (diameter and length). Even small variations from the controlled test conditions can greatly affect the ratings of the fuse-holder. For this reason, it is recommended that fuseholders be derated by 40% (operated at no more than 60% of the nominal current rating established using the Underwriter Laboratories test conditions, as previously stated).

11. TESTING: The factors presented here should be considered in selecting a fuse for a given application. The next step is to verify the selection by requesting samples for testing in the actual circuit. Before evaluating the samples, make sure the fuse is properly mounted with good electrical connections, using adequately sized wires or traces. The testing should include life tests under normal conditions and overload tests Under fault conditions, to ensure that the fuse will operate properly in the circuit.

CHART 1

WAVESHAPES	FORMULAS
A	$i = k$ $I^2t = i_p^2 t$
B	$i = i_p - kt$ $I^2t = (1/3)(i_p^2 + i_p i_b + i_b^2) t$
C	$i = i_p \sin t$ $I^2t = (1/2) i_p^2 t$
D	$I^2t = (1/3) i_p^2 t$
E	$i = kt^2$ OR $i = i_p(1-kt)^2$ $I^2t = (1/5) i_p^2 t$
F	$i = i_p e^{-kt}$ $I^2t \cong (1/2) i_p^2 t^1$

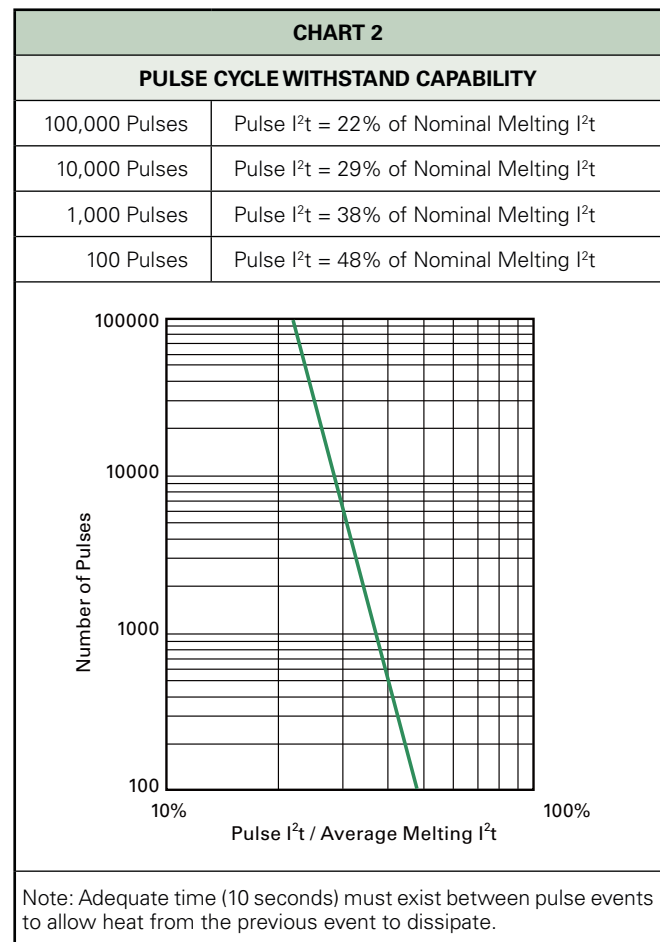

Standards

Littelfuse is at your service to help solve your electrical protection problems. When contacting Littelfuse sales engineers, please have all the requirements of your applications available. Requests for quotes or assistance in designing or selecting special types of circuit protection components for your particular special applications are also welcome. In the absence of special requirements, Littelfuse reserves the right to make appropriate changes in design, process, and manufacturing location without prior notice.

Fuse ratings and other performance criteria are evaluated under laboratory conditions **and acceptance criteria**, as defined in one or more of the various fuse standards. It is important to understand these standards so that the fuse can be properly applied to circuit protection applications.

UL/CSA/ANCE (Mexico) 248-14 FUSES FOR SUPPLEMENTARY OVERCURRENT PROTECTION (600 Volts, Maximum) (Previously UL 198G and CSA C22.2, No. 59)

UL LISTED

A UL Listed fuse meets all the requirements of the UL/CSA/ANCE 248-14 Standard. Following are some of the requirements. UL ampere rating tests are conducted at 100%, 135%, and 200% of rated current. The fuse must carry 100% of its ampere rating and must stabilize at a temperature that does not exceed a 75°C rise.

The fuse must open at 135% of rated current within one hour. It also must open at 200% of rated current within 2 minutes for 0-30 ampere ratings and 4 minutes for 35-60 ampere ratings.

The interrupting rating of a UL Listed fuse is 10,000 amperes AC minimum at 125 volts. Fuses rated at 250 volts may be listed as interrupting 10,000 amperes at 125 volts and, at least, the minimum values shown below at 250 volts.

Ampere Rating of Fuse	Interrupting Rating In Amperes	Voltage Rating
0 to 1	35	250 VAC
1.1 to 3.5	100	250 VAC
3.6 to 10	200	250 VAC
0.1 to 15	750	250 VAC
15.1 to 30	1500	250 VAC

Recognized Under the Component Program of Underwriters Laboratories

The Recognized Components Program of UL is different from UL Listing. UL will test a fuse to a specification requested by the manufacturer. The test points can be different from the UL Listed requirements if the fuse has been designed for a specific application. Application approval is required by UL for fuses recognized under the Component Program.

UL 275 AUTOMOTIVE GLASS TUBE FUSES (32 Volts)

UL LISTED

UL ampere ratings tests are conducted at 110%, 135%, and 200%. Interrupting rating tests are not required.

CSA Certification

CSA Certification in Canada is equivalent to UL Listing in the United States.

 The Component Acceptance Program of CSA is equivalent to the Recognition Program at UL.

METI (Japan Ministry of Economy, Trade and Industry)

METI APPROVAL



METI[®] approval in Japan is similar to UL Recognition in the United States.

METI[®] has its own design standard and characteristics.

INTERNATIONAL ELECTROTECHNICAL COMMISSION (IEC)

Publication 60127, Parts 1, 2, 3, 4, 6

The IEC organization is different from UL and CSA, since IEC only writes specifications and does not certify. UL and CSA write the specifications, and are responsible for testing and certification.

Certification to IEC specifications are given by such organizations as SEMKO (Swedish Institute of Testing and Approvals of Electrical Equipment) , BSI (British Standards Institute)  and VDE (German Standard Institute) , as well as UL and CSA.

IEC Publication 60127 defines three breaking capacity levels (interrupting rating). Low breaking capacity fuses must pass a test of 35 amperes or ten times rated current, whichever is greater, while enhanced breaking capacity fuses must pass a test of 150 amperes and high breaking capacity fuses must pass a test of 1500 amperes.

60127 Part 2

Sheet 1 — Type F Quick Acting, High Breaking Capacity

Sheet 2 — Type F Quick Acting, Low Breaking Capacity

Sheet 3 — Type T Time Lag, Low Breaking Capacity

Sheet 4 — Style Fuses 1/4 x 1 1/4

Sheet 5 — Type T Time Lag, High Breaking Capacity

Sheet 6 — Type T Time Lag, Enhanced Breaking Capacity

The letters 'F' and 'T' represent the time-current characteristic of the fast-acting and time delay fuses. One of these letters will be marked on the end cap of the fuse.

**UL/CSA/ANCE (Mexico) 248-14 vs. IEC 60127 Part 2
FUSE OPENING TIMES vs. METI/MITI®**

Percent of Rating	UL & CSA STD 248-14	IEC TYPE F Sheet 1 (*)	IEC TYPE F Sheet 2 (*)	IEC TYPE T Sheet 3 (*)	IEC TYPE T Sheet 5 (*)	METI/MITI®
110	4Hr.Min.	—	—	—	—	
130	—	—	—	—	—	1Hr.Min.
135	60 Minutes Max.	—	—	—	—	
150	—	60 Minutes Min.	60 Minutes Min.	60 Minutes Min.	60 Minutes Min.	
160	—	—	—	—	—	1Hr.Max.
200	2 Minutes Max.	—	—	—	—	2 Minutes Max.
210	—	30 Minutes Max.	30 Minutes Max.	2 Minutes Max.	30 Minutes Max.	

(*) Note: The IEC Specification is written up to 10.0A. Any components above these ratings are not recognized by the IEC (although the fuses may have similar opening characteristics).

IEC also has opening time requirements at 275%, 400% and 1000%; however, the chart is used to show that fuses with the same ampere rating made to different specifications are not interchangeable. According to the IEC 60127 Standard, a one ampere-rated fuse can be operated at one ampere. A one ampere-rated fuse made to UL/CSA/ANCE 248-14 should not be operated at more than .75 ampere (25% derated — See RERATING section of FUSEOLOGY).

METI® does not differentiate between fast acting and time delay characteristics.

Publication IEC 60127-4 (Universal Modular Fuse-Links [UMF])

This part of IEC 60127-4 covers both PCB through-hole and surface mount fuses. This standard covers fuses rated 32, 63, 125, and 250 volts. This standard will be accepted by UL/CSA making it the first global fuse standard. This specification uses different fusing gates than IEC 60127-2; the gates used here are 125%, 200%, and 1000%.

The fuses must not open in less than one hour at 125% of rated current and open within two minutes at 200% of rated current. The 1000% overload is used to determine the fuse characteristic. The opening time for each rating is listed below.

Type FF : Less than 0.001 sec.

Type F : From 0.001 - 0.01 sec.

Type T : From 0.01 - 0.1 sec.

Type TT : From 0.1 - 1.00 sec.

These characteristics correlate to the terminology used in IEC 60127-1.

Breaking capacity (interrupting rating) varies based on voltage rating. Parts rated at 32 & 63 volts must pass a test of 35 amperes or ten times rated current, whichever

is greater. Parts rated at 125 volts must pass a test of 50 amperes or ten times rated current, whichever is greater. Parts rated at 250 volts are further defined as either low, intermediate or high breaking. The low breaking capacity fuses must pass a test of 100 amperes rated current, while intermediate breaking capacity fuses must pass a test of 500 amperes and high breaking capacity fuses must pass a test of 1500 amperes.

MILITARY/FEDERAL STANDARDS
MIL-PRF-15160 and MIL-PRF-23419

These specifications govern the construction and performance of fuses suitable primarily for military electronic applications.

MIL-PRF-19207

This specification governs the construction and performance of fuseholders suitable for military applications.

DSSC Drawing #87108

This drawing governs the construction and performance of .177" x .570" (2AG size) cartridge fuses and axial lead versions suitable for military applications. DSSC #87108 designation is included in the fuse end cap marking.

FEDERAL SPECIFICATION W-F-1814

This specification governs the construction and performance of fuses with high interrupting ratings that are approved for federal applications. Fuses approved to these specifications are on the Federal Qualified Products List.

Write to the following agencies for additional information on standards, approvals, or copies of the specifications.

Underwriters Laboratories Inc. (UL)

333 Pfingsten Road
Northbrook, Illinois, USA
60062-2096

Canadian Standards Association (CSA)

5060 Spectrum Way, Suite 100
Mississauga, Ontario, Canada
L4W 5N6

International Electrotechnical Commission (IEC)

3, Rue de Varembe
1211 Geneva 20
Switzerland

Naval Publications and Military Standards Form Center (for Military and Federal Standards)

5801 Tabor Avenue
Philadelphia, Pennsylvania, USA
19120

Defense Supply Center Columbus (DSCC)

3990 East Broad Street
Columbus, Ohio, USA
43218-3990

Ministry of Economy Trade and Industry (METI)

1-3-1 Kasumigaseki
Chiyouda-ku
Tokyo 100-8901, Japan

Packaging and Part Numbering

Littelfuse Fuse Products Traditional Part Numbering System

O X X X X X X X X X X X X X X X X X X

Product Series Code
Example:
437 series fuse is "0437"

Ampere Rating Code
Decimal is to far right for whole number amp ratings, to far left for ratings less than one, and within center for fractional amp ratings.

Examples:
10A fuse is "010."
1/4A or 0.25A fuse is ".250"
1 1/2A or 1.5A fuse is "01.5"
1 1/4A or 1.25A fuse is "1.25"

Refer to the Electrical Characteristics tables presented in each product data sheet for specific amp rating codes

Packaging Quantity Code *

A/X 1	H 100	D 1500	N 5000
V 5	F 200	P 2000	K 10000
T 10	G 250	E 2500	J 12000
S 20	U 500	W 3000	Z Misc.
L 50	M 1000	Y 4000	

Packaging Type *

- A** Ammo packed
- B** Bubble packed
- C** Chip packed
- R** Reeled
- X** Filler

Options Codes *

- RT1** Reel and Tape, 2.062in (52.4mm) lead spacing
- RT2** Reel and Tape, 2.50 in (63.5mm) lead spacing
- RT3** Reel and Tape, 2.874 in (73mm) lead spacing
- E** Pigtail lead type fuse
- ID** Indicating fuse
- L** RoHS compliant
- P** Lead-free

* Not all options and codes listed here are available for all products. For information about the specific options available for any Littelfuse product, please refer to the packaging details information within each product data sheet or contact your Littelfuse products representative.

Tape and Reel packaging per EIA-296:

Tape width is defined as the width of the tape and reeled fuse (x) as measured from inside tape to inside tape. Pitch is defined as the space between two tape and reeled fuses (y) as measured from lead to lead.

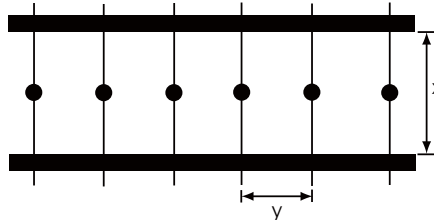

Littelfuse Wickmann Products Part Numbering System

1.-3.	4.	5.-7.	8.	9.	10.	Stelle digit	Explanation	
3xx	X	XXX	X	X	X			
TR3 303			0	4	3	0	Packaging Tape, Ammopack 1.000 pcs. TR5® Tape, Ammopack Tape, Ammopack Tap, Rolle/ Reel bulk, 1.000 pcs. TR5® bulk, 300 pcs., TR3 short leads bulk, 200 pcs., TR3 long leads / TR® bulk 1.400 pcs., only TE5® / T°C P / MP / IP tape in bulk 100 pcs., only Picofuse 275 bulk 2.500 pcs., only Picofuse 275 customized	
TR5® 370						1		
372						2		
382						3		
385						4		
391						5		
950						6		
373						Y		
374								
TE5® 392						0		Variant 0 Standard, long leads 18,8 mm 1 long leads 18,8 mm, TR3 2 4 short leads 4,3 mm 5 short leads 3,3 / 3,5 mm (special model)
395						1		
396						2		
T°C P 397						0	Version 0 Standard 1 varying production S PIP Surface Mount (TR5 blister tape 2x500 pcs.)	
MP 398						1		
IP 399						S		
Pico 275							Rated Current Specification 3-digit = 62mA = 100mA / 1A / 10A = 125A example 4.-7. digit 0062 = 62mA 0100 = 100mA 1100 = 1A 2100 = 10A 3125 = 125A 0 < 1A 1 ≥ 1 - < 10A 2 ≥ 10 - < 100A 3 ≥ 100A	
						062		
						100		
						125		
						0		

RoHS HF 437 Series – 1206 Fast-Acting Fuse

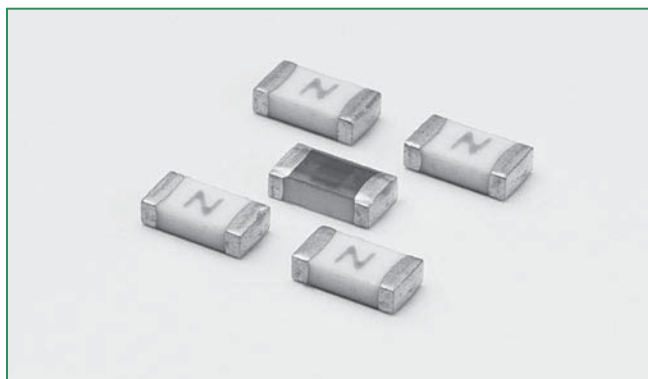



Description

This 100% Lead-free, RoHS compliant and Halogen-free fuse series has been designed specifically to provide over current protection to circuits that see high working ambient temperatures (up to 150°C).

The general design ensures excellent temperature stability and performance reliability.

In addition to this, the high I²t values typical of the Littelfuse Ceramic Fuse family ensure high inrush current withstand capability.

Agency Approvals

AGENCY	AGENCY FILE NUMBER	AMPERE RANGE
	E10480	0.250A ~ 8A
	LR29862	0.250A ~ 8A

Electrical Characteristics for Series

% of Ampere Rating	Ampere Rating	Opening Time at 25°C
100%	250mA - 8A	4 hours, Minimum
250%	750mA - 8A	5 seconds, Maximum
350%	250mA - 500mA	5 seconds, Maximum
350%	750mA - 8A	1 second, Maximum



Features

- Operating Temperature from -55°C to +150°C
- Suitable for both leaded and lead-free reflow / wave soldering
- 100% Lead-free and RoHS compliant

Applications

- Automotive Electronics
- LCD Displays
- Servers
- Printers
- Scanners
- Data Modems

Electrical Specifications by Item

Ampere Rating (A)	Amp Code	Max. Voltage Rating (V)	Interrupting Rating	Nominal Resistance (Ohms) ²	Nominal Melting I ² t (A ² Sec.) ³	Nominal Voltage Drop At Rated Current (V) ⁴	Nominal Power Dissipation At Rated Current (W)	Agency Approvals	
									
250mA	.250	125	50 A @ 125 V AC/DC	2.290	0.003	0.78	0.195	x	x
375mA	.375	125		1.330	0.010	0.60	0.225	x	x
500mA	.500	63		0.908	0.018	0.52	0.260	x	x
750mA	.750	63	50 A @ 63 V AC/DC	0.665	0.064	0.45	0.335	x	x
1A	001.	63		0.360	0.100	0.41	0.415	x	x
1.25A	1.25	63		0.318	0.256	0.40	0.496	x	x
1.5A	01.5	63		0.209	0.324	0.39	0.579	x	x
1.75A	1.75	63		0.0703	0.075	0.27	0.474	x	x
2A	002.	63		0.058	0.144	0.17	0.345	x	x
2.5A	02.5	32	50 A @ 32 V AC/DC	0.043	0.225	0.14	0.363	x	x
3A	003.	32		0.033	0.400	0.15	0.462	x	x
3.5A	03.5	32		0.027	0.576	0.16	0.560	x	x
4A	004.	32		0.022	1.024	0.16	0.618	x	x
5A	005.	32		0.016	1.936	0.09	0.484	x	x
7A	007.	32		0.010	4.900	0.11	0.760	x	x
8A	008.	32		0.0084	6.400	0.067	0.539	x	x

Notes:

1. AC Interrupting Rating tested at rated voltage with unity power factor. DC Interrupting Rating tested at rated voltage with time constant < 0.8 msec.
2. Nominal Resistance measured with < 10% rated current.
3. Nominal Melting I²t measured at 1 msec. opening time.
4. Nominal Voltage Drop measured at rated current after temperature has stabilized.

Devices designed to carry rated current for 4 hours minimum. It is recommended that devices be operated continuously at no more than 80% rated current. See "Temperature Derating Curve" for additional derating information.

Devices designed to be mounted with marking code facing up.

Temperature Derating Curve

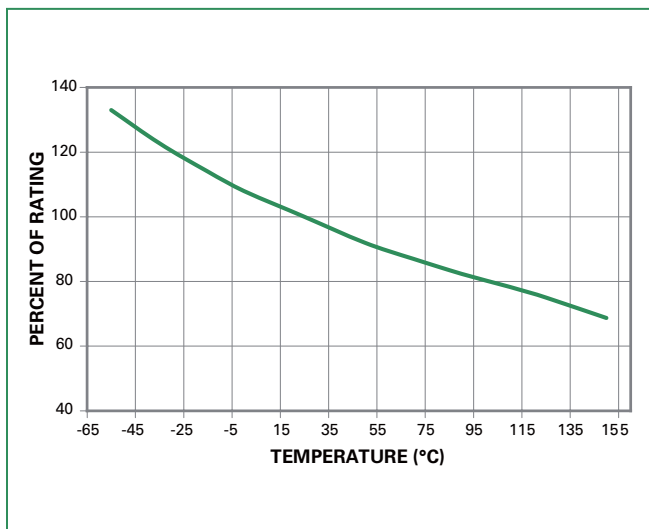

Note:

1. Derating depicted in this curve is in addition to the standard derating of 20% for continuous operation.

Example:

For continuous operation at 75 degrees celsius, the fuse should be derated as follows:

$$I = (0.80)(0.85)_{RAT} = (0.68)_{RAT}$$

Average Time Current Curves

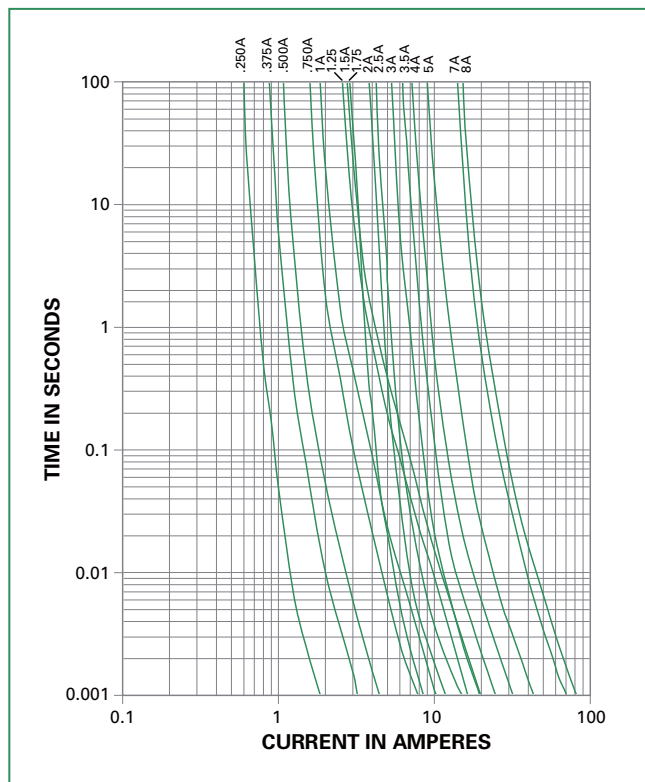

Soldering Parameters

Reflow Condition	Pb – free assembly	
Pre Heat	- Temperature Min ($T_{s(min)}$)	150°C
	- Temperature Max ($T_{s(max)}$)	200°C
	- Time (Min to Max) (t_s)	60 – 180 seconds
Average Ramp-up Rate (Liquidus Temp (T_L) to peak)	3°C/second max.	
$T_{s(max)}$ to T_L - Ramp-up Rate	5°C/second max.	
Reflow	- Temperature (T_L) (Liquidus)	217°C
	- Temperature (t_L)	60 – 150 seconds
Peak Temperature (T_p)	260 ^{+0/-5} °C	
Time within 5°C of actual peak Temperature (t_p)	10 – 30 seconds	
Ramp-down Rate	6°C/second max.	
Time 25°C to peak Temperature (T_p)	8 minutes max.	
Do not exceed	260°C	

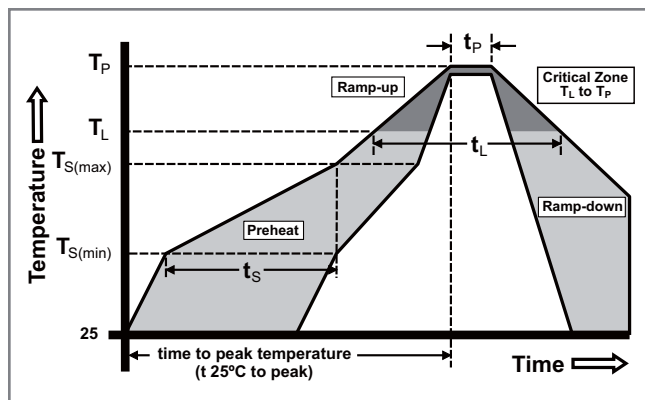

Wave Soldering	260°C, 10 seconds max.
----------------	------------------------

Product Characteristics

Materials	Body: Advanced Ceramic Terminations: Ag / Ni / Sn (100% Lead-free) Element Cover Coating: Lead-free Glass
Moisture Sensitivity Level	IPC/JEDEC J-STD-020C, Level 1
Solderability	IPC/EIC/JEDEC J-STD-002B, Condition B
Humidity Test	MIL-STD-202, Method 103B, Conditions D
ESD Immunity	IEC 61000-4-2, 8kV Direct
Resistance to Solder Heat	MIL-STD-202, Method 210F, Condition B

Moisture Resistance	MIL-STD-202, Method 106G
Thermal Shock	MIL-STD-202, Method 107G, Condition B
Mechanical Shock	MIL-STD-202, Method 213B, Condition A
Vibration	MIL-STD-202, Method 201A
Vibration, High Frequency	MIL-STD-202, Method 204D, Condition D
Dissolution of Metallization	IPC/EIC/JEDEC J-STD-002B, Condition D
Terminal Strength	IEC 60127-4

Dimensions

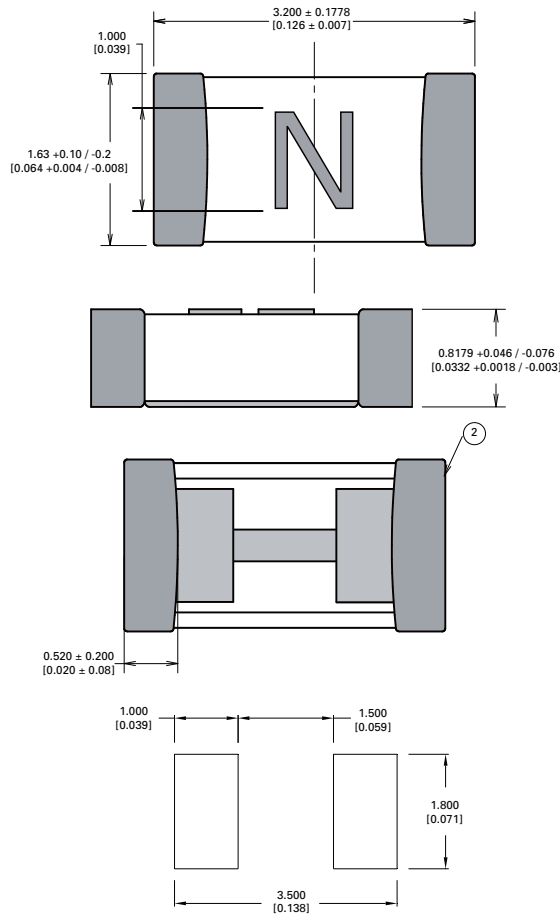

Part Marking System

Amp Code	Marking Code
.250	D
.375	E
.500	F
.750	G
001.	H
1.25	J
01.5	K
1.75	L
002.	N
02.5	O
003.	P
03.5	R
004.	S
005.	T
007.	W
008.	X

Part Numbering System

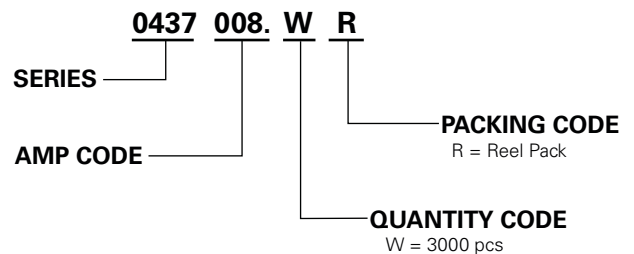

Packaging

Packaging Option	Packaging Specification	Quantity	Quantity & Packaging Code
8mm Tape and Reel	EIA-481-1 (IEC 286, part 3)	3000	WR

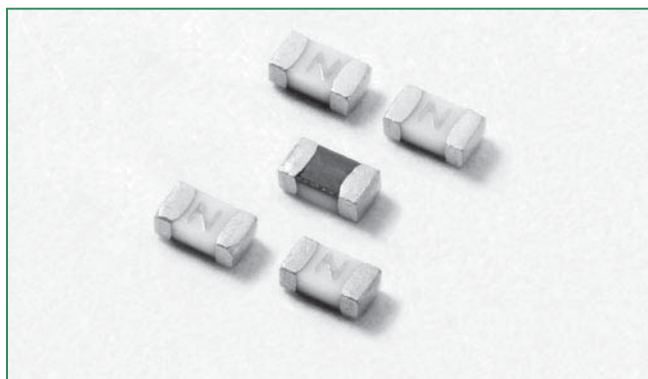

RoHS Pb HF 438 Series – 0603 Fast-Acting Fuse

Description

The 438 Series is a 100% Lead-free, RoHS compliant and Halogen-free fuse series designed specifically to provide over-current protection to circuits that operate under high working ambient temperature up to 150°C.

The general design ensures excellent temperature stability and performance reliability.

The high I²t values which is typical in the Littelfuse Ceramic Fuse family ensure high inrush current withstand capability.

Agency Approvals

AGENCY	AGENCY FILE NUMBER	AMPERE RANGE
	E10480	0.250A – 6A
	LR29862	0.250A – 6A

Features

- Operating Temperature from -55°C to +150°C
- Suitable for both leaded and lead-free reflow / wave soldering
- 100% Lead-free, RoHS compliant and Halogen-free



Electrical Characteristics for Series

% of Ampere Rating	Ampere Rating	Opening Time at 25°C
100%	0.250A – 6A	4 Hours, Minimum
250%	0.250A – 6A	5 Seconds, Maximum

Applications

- Handheld Electronics
- Hard Disk Drives
- LCD Displays
- SD Memory Cards
- Battery Packs
- Automotive Electronics

Electrical Specifications by Item

Ampere Rating (A)	Amp Code	Max. Voltage Rating (V)	Interrupting Rating	Nominal Resistance (Ohms) ²	Nominal Melting I ² t (A ² Sec.) ³	Nominal Voltage Drop At Rated Current (V) ⁴	Nominal Power Dissipation At Rated Current (W)	Agency Approvals	
									
0.25	.250	32	50 A @ 32 VDC	2.024	0.0017	0.550	0.138	x	x
0.375	.375	32		1.247	0.0041	0.488	0.183	x	x
0.5	.500	32		0.829	0.0100	0.486	0.243	x	x
0.75	.750	32		0.466	0.0281	0.378	0.284	x	x
1	001.	32		0.310	0.0593	0.351	0.351	x	x
1.25	1.25	32		0.200	0.0510	0.365	0.456	x	x
1.5	01.5	32		0.174	0.0902	0.368	0.552	x	x
1.75	1.75	32		0.125	0.1440	0.360	0.540	x	x
2	002.	32		0.051	0.1490	0.107	0.214	x	x
2.5	02.5	32		0.0324	0.1977	0.095	0.238	x	x
3	003.	32		0.0252	0.2922	0.093	0.279	x	x
3.5	03.5	32		0.0203	0.4752	0.082	0.287	x	x
4	004.	32		0.0169	0.6920	0.079	0.316	x	x
5	005.	32		0.0113	0.7398	0.074	0.370	x	x
6	006.	24		50 A @ 24 VDC	0.0087	1.3838	0.072	0.432	x

Notes:

- AC Interrupting Rating tested at rated voltage with unity power factor. DC Interrupting Rating tested at rated voltage with time constant < 0.8 msec.
- Nominal Resistance measured with < 10% rated current.
- Nominal Melting I²t measured at 1 msec. opening time.
- Nominal Voltage Drop measured at rated current after temperature has stabilized.

Devices designed to carry rated current for 4 hours minimum. It is recommended that devices be operated continuously at no more than 80% rated current. See "Temperature Derating Curve" for additional derating information.

Devices designed to be mounted with marking code facing up.

Temperature Derating Curve

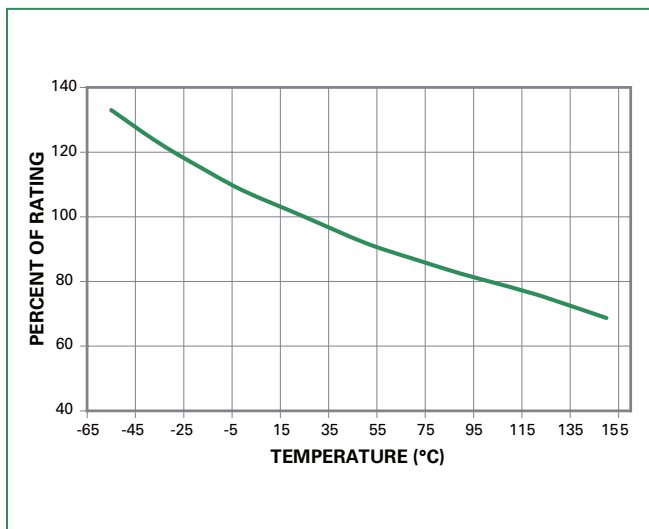

Note:

1. Derating depicted in this curve is in addition to the standard derating of 20% for continuous operation.

Example:

For continuous operation at 75 degrees celsius, the fuse should be derated as follows:

$$I = (0.80)(0.85)I_{RAT} = (0.68)I_{RAT}$$

Average Time Current Curves

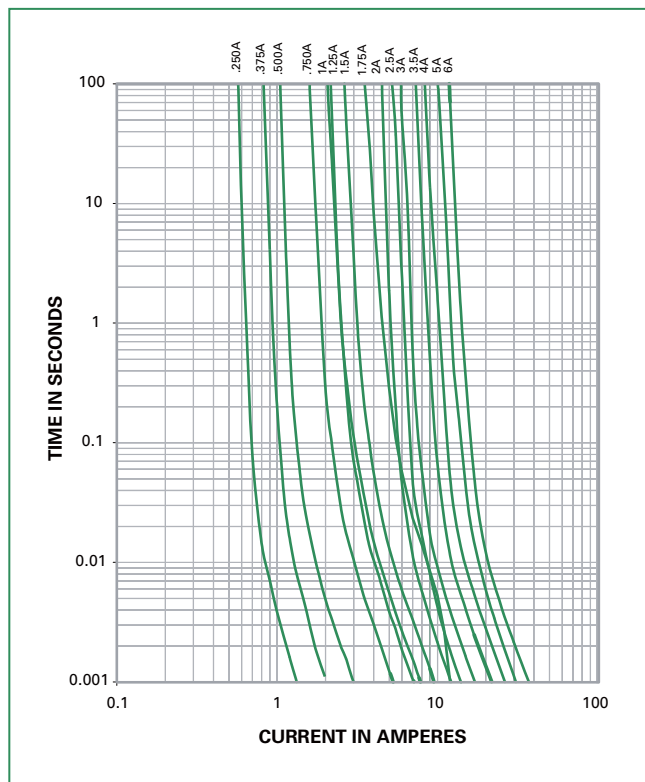

Soldering Parameters

Reflow Condition	Pb – free assembly	
Pre Heat	- Temperature Min ($T_{s(min)}$)	150°C
	- Temperature Max ($T_{s(max)}$)	200°C
	- Time (Min to Max) (t_s)	60 – 180 seconds
Average Ramp-up Rate (Liquidus Temp (T_L) to peak)	3°C/second max.	
$T_{s(max)}$ to T_L - Ramp-up Rate	5°C/second max.	
Reflow	- Temperature (T_L) (Liquidus)	217°C
	- Temperature (t_L)	60 – 150 seconds
Peak Temperature (T_p)	260 ^{+0/-5} °C	
Time within 5°C of actual peak Temperature (t_p)	10 – 30 seconds	
Ramp-down Rate	6°C/second max.	
Time 25°C to peak Temperature (T_p)	8 minutes max.	
Do not exceed	260°C	

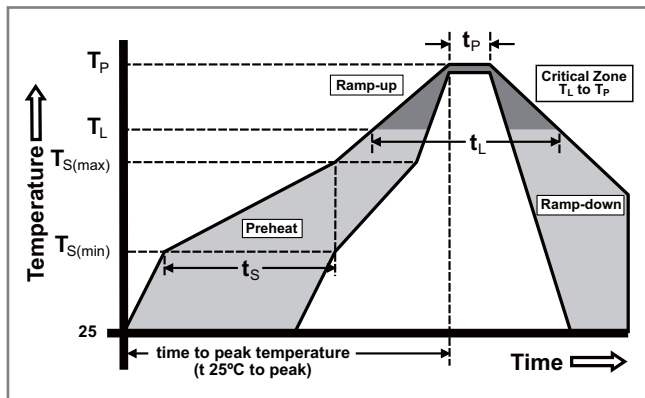

Wave Soldering	260°C, 10 seconds max.
----------------	------------------------

Product Characteristics

Materials	Body: Advanced Ceramic Terminations: Ag / Ni / Sn (100% Lead-free) Element Cover Coating: Lead-free Glass
Moisture Sensitivity Level	IPC/JEDEC J-STD-020C, Level 1
Solderability	IPC/EIC/JEDEC J-STD-002B, Condition B
Humidity	MIL-STD-202, Method 103B, Conditions D
ESD Immunity	IEC 61000-4-2, 8kV Direct
Resistance to Solder Heat	MIL-STD-202, Method 210F, Condition B

Moisture Resistance	MIL-STD-202, Method 106G
Thermal Shock	MIL-STD-202, Method 107G, Condition B-3
Mechanical Shock	MIL-STD-202, Method 213B, Condition A
Vibration	MIL-STD-202, Method 201A
Vibration, High Frequency	MIL-STD-202, Method 204D, Condition D
Dissolution of Metallization	IPC/EIC/JEDEC J-STD-002B, Condition D
Terminal Strength	IEC 60127-4

Dimensions

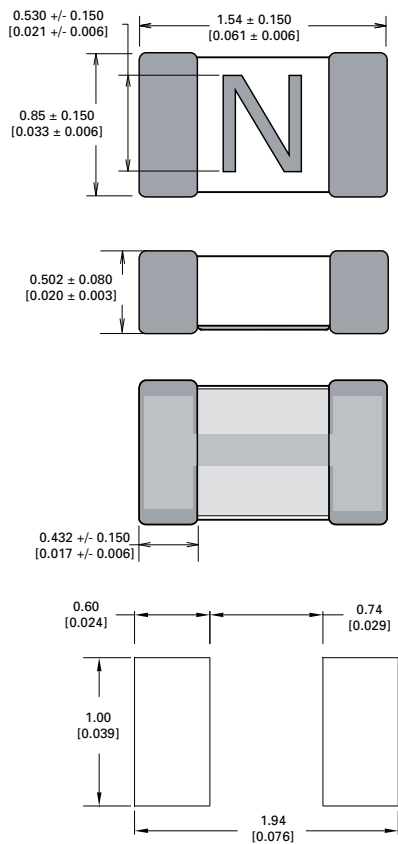

Part Marking System

Amp Code	Marking Code
.250	D
.375	E
.500	F
.750	G
001.	H
1.25	J
01.5	K
1.75	L
002.	N
02.5	O
003.	P
03.5	R
004.	S
005.	T
006.	U

Part Numbering System

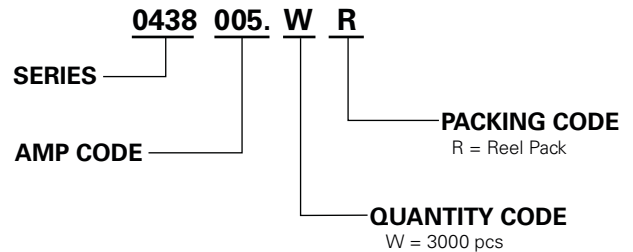

Packaging

Packaging Option	Packaging Specification	Quantity	Quantity & Packaging Code
8mm Tape and Reel	EIA-481-1 (IEC 286, part 3)	3000	WR

RoHS  HF **501 Series – High Current 1206 Fast-Acting Fuse**

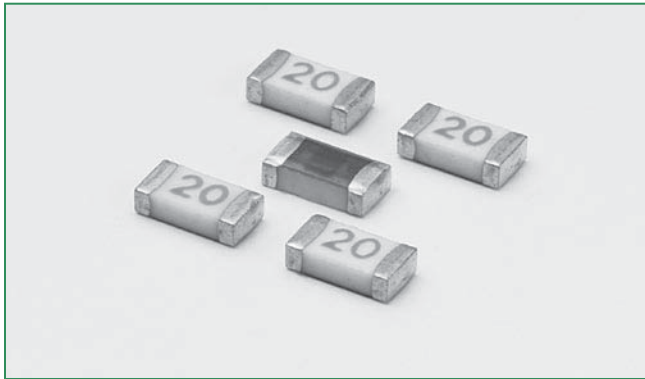



Description

The 501 Series is a 100% Lead-free, RoHS compliant and Halogen-free fuse series designed specifically to provide over-current protection to circuits that operate under high working ambient temperature up to 150°C.

The general design ensures excellent temperature stability and performance reliability.

The high I²t values which is typical in the Littelfuse Ceramic Fuse family, ensure high inrush current withstand capability.

Agency Approvals

AGENCY	AGENCY FILE NUMBER	AMPERE RANGE
	E10480	10A - 20A
	LR29862	10A - 20A

Features

- Operating Temperature from -55°C to +150°C
- Designed to provide over-current protection in high current voltage regulator module (VRM) applications
- 1100% Lead-free, RoHS compliant and Halogen-free
- Suitable for both leaded and lead-free reflow / wave soldering applications



Electrical Characteristics for Series

% of Ampere Rating	Ampere Rating	Opening Time at 25°C
100%	10A – 20A	4 Hours, Minimum
350%	10A – 20A	5 Seconds, Maximum

Applications

- Voltage Regulator Module (VRM) Equipment
- Notebook PC
- DC-DC Converter

Electrical Specifications by Item

Ampere Rating (A)	Amp Code	Max. Voltage Rating (V)	Interrupting Rating (DC) ¹	Nominal Resistance (Ohms) ²	Nominal Melting I ² T (A ² Sec.) ³	Nominal Voltage Drop At Rated Current (V) ⁴	Nominal Power Dissipation At Rated Current (W)	Agency Approvals	
									
10	010.	24	150 A @ 24 VDC	0.00427	10.385	0.05679	0.5679	x	x
12	012.	24		0.00321	20.341	0.04891	0.5870	x	x
15	015.	24		0.00250	36.100	0.04605	0.6908	x	x
20	020.	24		0.00200	54.760	0.05936	1.1871	x	x

Notes:

- DC Interrupting Rating tested at rated voltage with time constant < 0.8 msec.
- Nominal Resistance measured with < 10% rated current.
- Nominal Melting I²t measured at 1 msec. opening time. For other I²t data refer to chart.
- Nominal Voltage Drop measured at rated current after temperature has stabilized and with fuse mounted on board with 3-oz Cu trace.

Devices designed to carry rated current for 4 hours minimum. It is recommended that devices be operated continuously at no more than 80% rated current. See "Temperature Rerating Curve" for additional rerating information.

Devices designed to be mounted with marking code facing up.

501 Series

Temperature Derating Curve

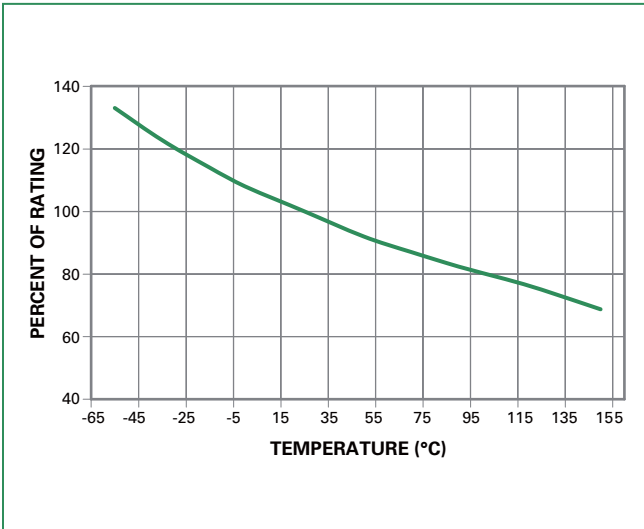

Note:

1. Derating depicted in this curve is in addition to the standard derating of 20% for continuous operation.

Example:

For continuous operation at 75 degrees celsius, the fuse should be derated as follows:

$$I = (0.80)(0.85)I_{RAT} = (0.68)I_{RAT}$$

Average Time Current Curves

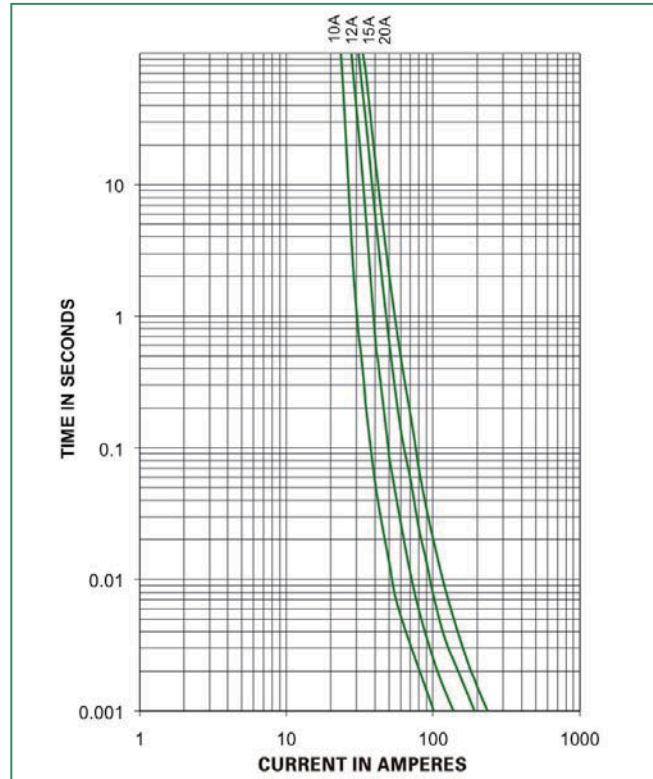

Soldering Parameters

Reflow Condition	Pb – free assembly	
Pre Heat	- Temperature Min ($T_{s(min)}$)	150°C
	- Temperature Max ($T_{s(max)}$)	200°C
	- Time (Min to Max) (t_s)	60 – 180 seconds
Average Ramp-up Rate (Liquidus Temp (T_L) to peak)	3°C/second max.	
$T_{s(max)}$ to T_L - Ramp-up Rate	5°C/second max.	
Reflow	- Temperature (T_L) (Liquidus)	217°C
	- Temperature (t_L)	60 – 150 seconds
Peak Temperature (T_p)	260 ^{+0/-5} °C	
Time within 5°C of actual peak Temperature (t_p)	10 – 30 seconds	
Ramp-down Rate	6°C/second max.	
Time 25°C to peak Temperature (T_p)	8 minutes max.	
Do not exceed	260°C	

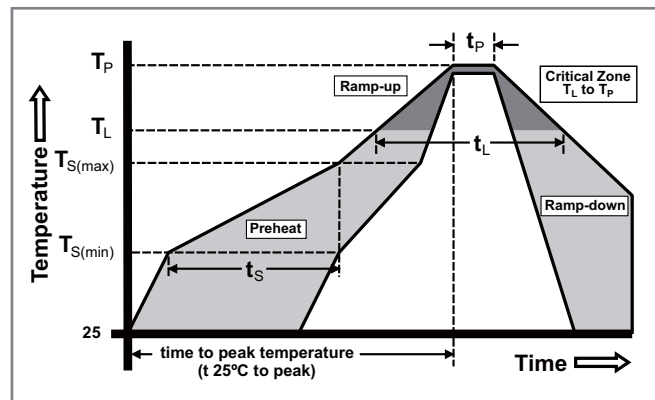

Wave Soldering	260°C, 10 seconds max.
----------------	------------------------

Product Characteristics

Materials	Body: Advanced Ceramic Terminations: Ag / Ni / Sn (100% Lead-free) Element Cover Coating: Lead-free Glass
Moisture Sensitivity Level	IPC/JEDEC J-STD-020C, Level 1
Solderability	IPC/ECA/JEDEC J-STD-002C, Condition B
Humidity Test	MIL-STD-202, Method 103B, Conditions D
ESD Immunity	IEC 61000-4-2, 8kV Direct
Resistance to Solvents	MIL-STD-202, Method 210F, Condition B

Moisture Resistance	MIL-STD-202, Method 106G
Thermal Shock	MIL-STD-202, Method 107G, Condition B
Mechanical Shock	MIL-STD-202, Method 213B, Condition A
Vibration	MIL-STD-202, Method 201A
Vibration, High Frequency	MIL-STD-202, Method 204D, Condition D
Dissolution of Metallization	IPC/ECA/JEDEC J-STD-002C, Condition D
Terminal Strength	IEC 60127-4

Dimensions

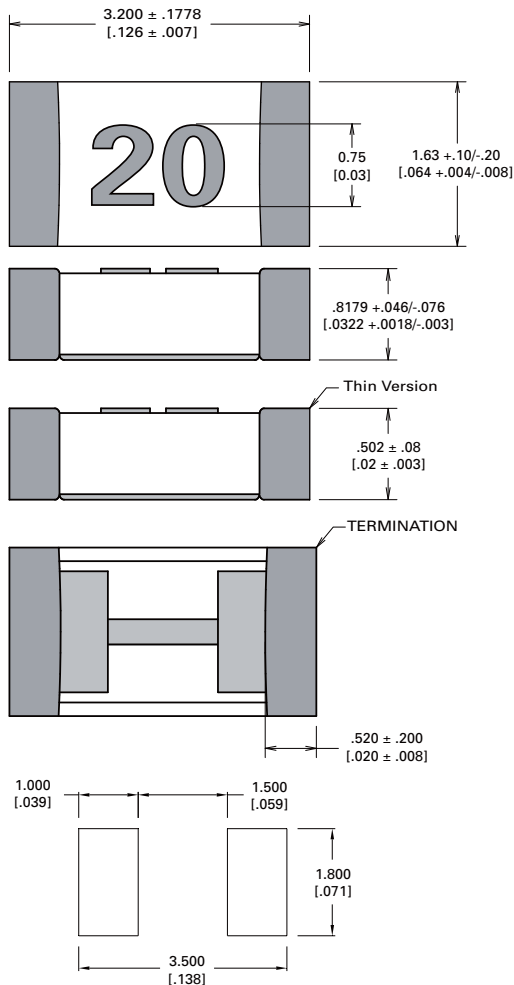

Part Marking System

Amp Code	Marking Code
010.	10
012.	12
015.	15
020.	20

Part Numbering System

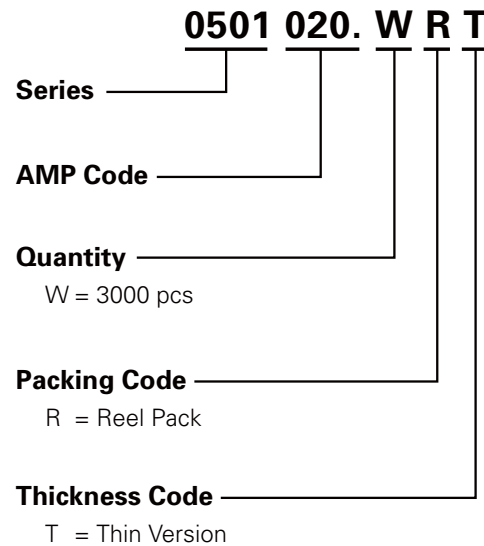

Packaging

Packaging Option	Packaging Specification	Quantity	Quantity & Packaging Code
8mm Tape and Reel	EIA-481-1 (IEC 286, part 3)	3000	WR

RoHS  **HF 466 Series Fuse**



Description



The 466 Series Fast-Acting Surface Mount Fuse (SMF) is a small (1206 size) thin-film device designed for secondary protection of circuits used in space constrained applications such as hand-held portable electronic devices.

This series is 100% lead-free and meets the requirements of the RoHS directive. New Halogen-Free 466 Series fuses are available to order using the "HF" suffix. See Part Numbering section for additional information.

Features

- Product is compatible with lead-free solders and higher temperature profiles
- Product is marked on top surface with code to allow amperage rating identification without testing
- Low profile for height sensitive applications
- Flat top surface for pick-and-place operations
- Element-covering material is resistant to industry standard cleaning operations
- Mounting pad and electrical performance are identical to Littelfuse 429 and 433 Series products
- Alloy-based element construction provides superior inrush withstand characteristics (I^2t) over ceramic or glass-based 1206 chip fuse products

Agency Approvals

AGENCY	AGENCY FILE NUMBER	AMPERE RANGE
	E10480	125mA - 5A
	LR29862	125mA - 5A

Electrical Characteristics for Series



% of Ampere Rating	Opening Time at 25°C
100%	4 hours, Minimum
200%	5 sec., Maximum
300%	0.2 sec., Maximum

Applications

Secondary protection for space constrained applications:

- Cell phones
- Battery packs
- Digital cameras
- DVD players
- Hard disk drives

Electrical Specifications by Item

Ampere Rating (A)	Amp Code	Max Voltage Rating (V)	Interrupting Rating	Nominal Cold Resistance (Ohms)	Nominal Melting I^2t (A ² sec)	Nom Voltage Drop (mV)	Nom Power Dissipation (W)	Agency Approvals	
									
0.125	.125	125	50A @125 V AC/DC	4.000	0.00040	552.66	0.0691	x	x
0.200	.200	125		1.160	0.00055	254.28	0.0509	x	x
0.250	.250	125		0.710	0.0010	207.01	0.0518	x	x
0.375	.375	125	50A @63 V AC/DC	0.350	0.0028	169.18	0.0634	x	x
0.500	.500	63		0.248	0.0060	158.47	0.0792	x	x
0.750	.750	63		0.111	0.0276	98.65	0.0740	x	x
1.00	001.	63		0.076	0.0423	89.94	0.0899	x	x
1.25	1.25	63		0.059	0.0640	85.71	0.1071	x	x
1.50	01.5	63		0.048	0.1103	82.97	0.1244	x	x
1.75	1.75	63	50A @32 V AC/DC	0.039	0.1323	80.73	0.1413	x	x
2.00	002.	63		0.031	0.2326	78.73	0.1575	x	x
2.50	02.5	32		0.024	0.3516	76.99	0.1925	x	x
3.00	003.	32		0.020	0.5760	75.99	0.2280	x	x
4.00	004.	32		0.014	1.024	74.50	0.2980	x	x
5.00	005.	32		0.011	1.600	73.75	0.3688	x	x

1. Measured at 10% of rated current, 25°C.

2. Measured at rated voltage.

Temperature Derating Curve

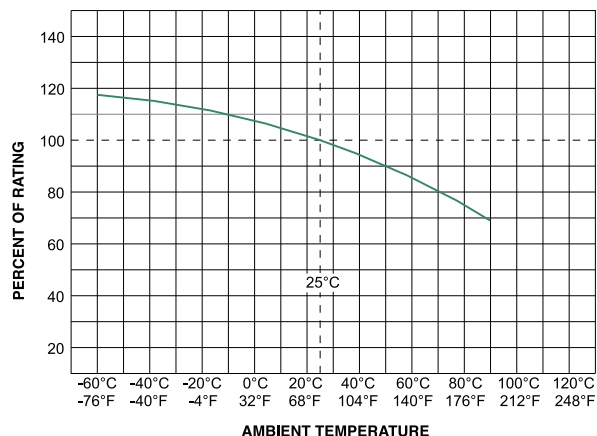

Note:

1. Derating depicted in this curve is in addition to the standard derating of 25% for continuous operation.

Example:

For continuous operation at 70 degrees celsius, the fuse should be rated as follows:

$$I = (0.75)(0.80)I_{RAT} = (0.60)I_{RAT}$$

Average Time Current Curves

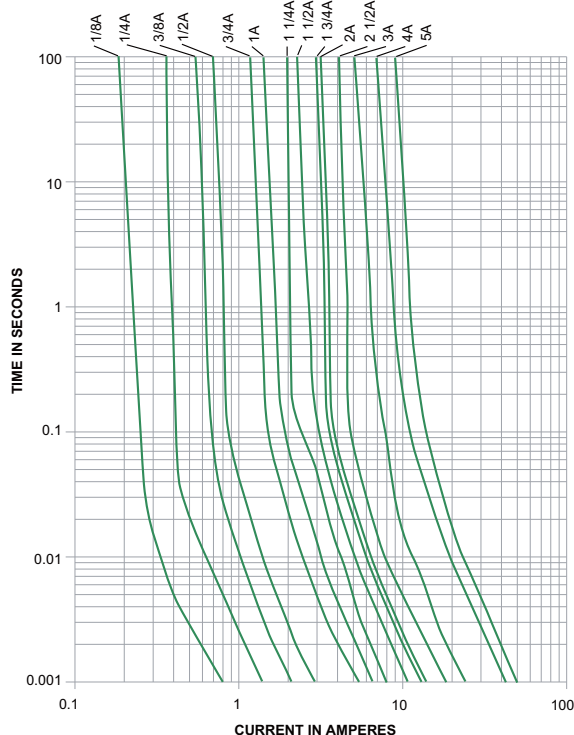

Soldering Parameters

Reflow Condition		Pb – free assembly
Pre Heat	- Temperature Min ($T_{s(min)}$)	150°C
	- Temperature Max ($T_{s(max)}$)	200°C
	- Time (Min to Max) (t_s)	60 – 180 seconds
Average Ramp-up Rate (Liquidus Temp (T_L) to peak)		5°C/second max.
$T_{s(max)}$ to T_L - Ramp-up Rate		5°C/second max.
Reflow	- Temperature (T_L) (Liquidus)	217°C
	- Temperature (t_L)	60 – 150 seconds
Peak Temperature (T_p)		250 ^{+0/-5} °C
Time within 5°C of actual peak Temperature (t_p)		20 – 40 seconds
Ramp-down Rate		5°C/second max.
Time 25°C to peak Temperature (T_p)		8 minutes max.
Do not exceed		260°C

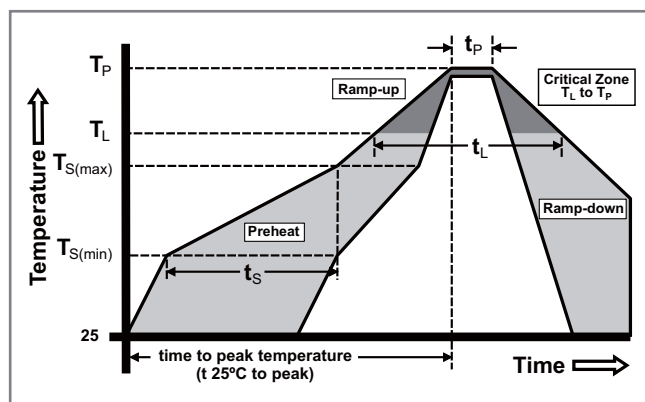

Wave Soldering	260°C, 10 seconds max.
----------------	------------------------

Product Characteristics

Materials	Body: Advanced High Temperature Substrate Terminations: 100% Tin over Nickel over Copper Element Cover Coat: Conformal Coating
Operating Temperature	- 55°C to 90°C. Consult temperature derating curve chart.
Thermal Shock	Withstands 5 cycles of -55°C to 125°C
Humidity	MIL-STD-202F, Method 103B, Condition D

Vibration	Per MIL-STD-202F, Method 201A
Insulation Resistance (After Opening)	Greater than 10,000 ohms
Resistance to Soldering Heat	MIL-STD-202G, Method 210F, Condition D

Dimensions

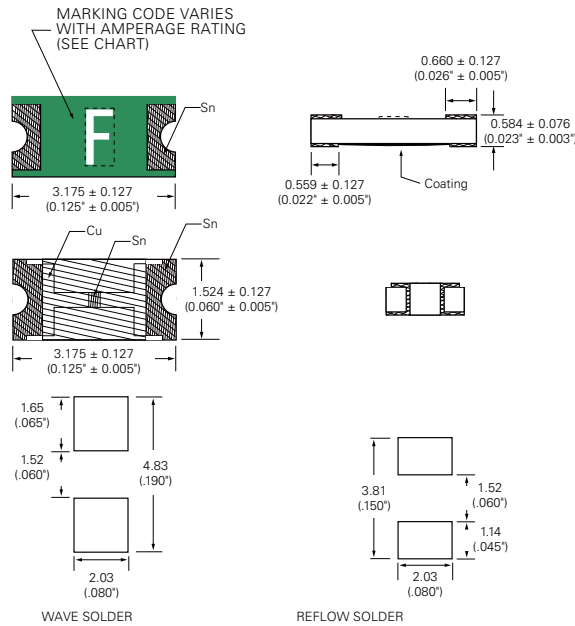

Part Marking System

Amp Code	Marking Code
.125	B
.200	C
.250	D
.375	E
.500	F
.750	G
001.	H
1.25	J
01.5	K
1.75	L
002.	N
02.5	O
003.	P
004.	S
005.	T

Part Numbering System

0466002.NRHF

SERIES

AMP Code

Refer to Amp Code column in the Electrical Specifications table. The dot is positioned before the Packaging Suffix with whole ratings and within the numbering sequence for fractional ratings.

QUANTITY Code

N = 5000 pcs

PACKAGING Code

R = Tape and Reel

'HF' SUFFIX

HALOGEN FREE ITEM

Example:

.125 amp product is 0466.**125** NR HF (2 amp product shown above).

Packaging

Packaging Option	Packaging Specification	Quantity	Quantity & Packaging Code
8mm Tape and Reel	EIA RS-481-2 (IEC 286, part 3)	5000	NR

RoHS  **HF 429 Series Fuse**

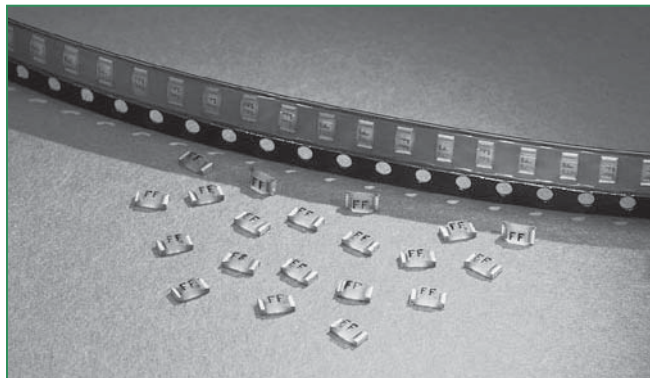

Description



The 429 Series Fast-Acting SMF is a small (1206 size) thin-film device designed for secondary protection of circuits used in space constrained applications such as hand-held portable electronic devices.

This series is Halogen-Free, Lead-Free and meets the requirements of the RoHS directive.

Features

- RoHS compliant and Lead-Free 7A device available-add 'L' suffix to part number.
- Halogen-Free 7A device available-add 'HF' suffix to the part number
- **For new designs up to 5A please consult the 433 or 466 Series**

Agency Approvals

AGENCY	AGENCY FILE NUMBER	AMPERE RANGE
	E10480	7A
	LR29862	7A

Electrical Characteristics for Series



% of Ampere Rating	Opening Time at 25°C
100%	4 hours, Minimum
200%	5 sec., Maximum
300%	0.2 sec., Maximum

Applications

Secondary protection for space constrained applications such as:

- Cell phones
- Battery packs
- Digital cameras
- DVD players
- Hard disk drives.

Electrical Specifications by Item

Ampere Rating (A)	Amp Code	Max Voltage Rating (V)	Interrupting Rating	Nominal Cold Resistance (Ohms)	Nominal Melting I ² t (A ² sec)	Agency Approvals	
							
7.00	007.	24	35 amperes @ voltage, VAC/DC	0.00925	3.6000	x	x

1. Measured at 10% of rated current, 25°C.
2. Measured at rated voltage.

Temperature Derating Curve

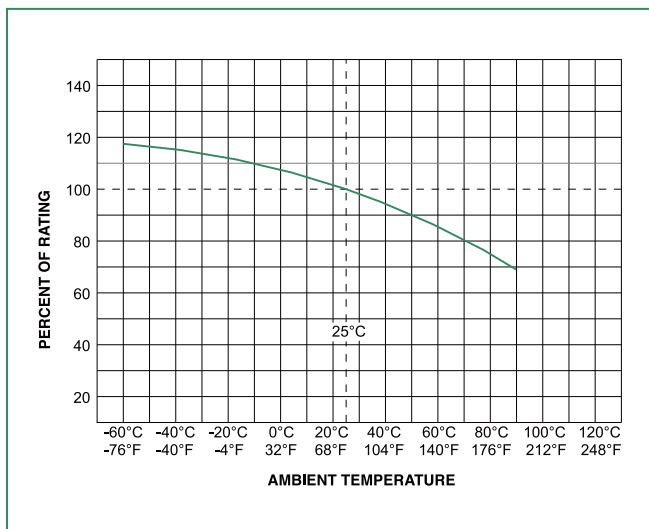

Note:

- Derating depicted in this curve is in addition to the standard derating of 25% for continuous operation.

Example:

For continuous operation at 70 degrees celsius, the fuse should be derated as follows:

$$I = (0.75)(0.80)I_{RAT} = (0.60)I_{RAT}$$

Average Time Current Curves

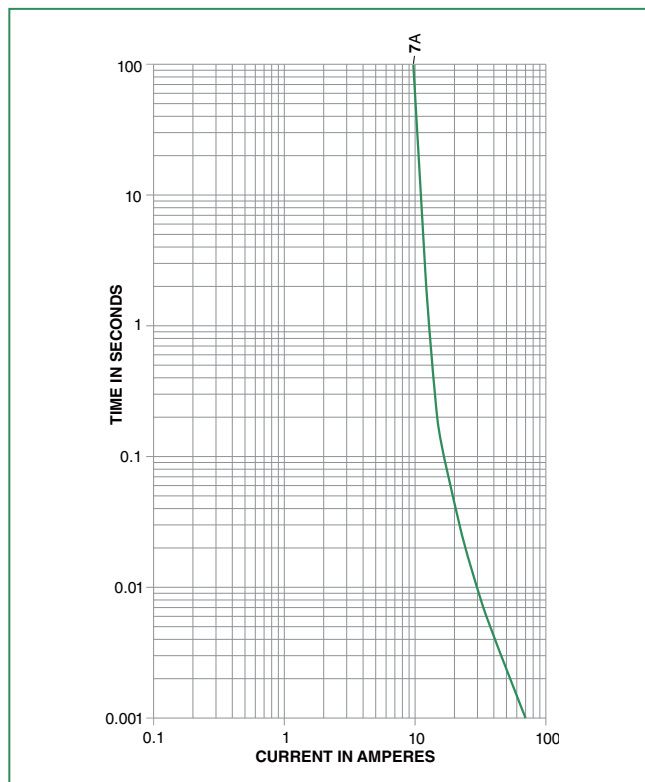

Soldering Parameters

Reflow Condition		Pb – Free assembly
Pre Heat	- Temperature Min ($T_{s(min)}$)	150°C
	- Temperature Max ($T_{s(max)}$)	200°C
	- Time (Min to Max) (t_s)	60 – 180 secs
Average ramp up rate (Liquidus Temp (T_L) to peak)		5°C/second max
$T_{s(max)}$ to T_L - Ramp-up Rate		5°C/second max
Reflow	- Temperature (T_L) (Liquidus)	217°C
	- Temperature (t_L)	60 – 150 seconds
Peak Temperature (T_p)		250 ^{+0/-5} °C
Time within 5°C of actual peak Temperature (t_p)		20 – 40 seconds
Ramp-down Rate		5°C/second max
Time 25°C to peak Temperature (T_p)		8 minutes Max.
Do not exceed		260°C

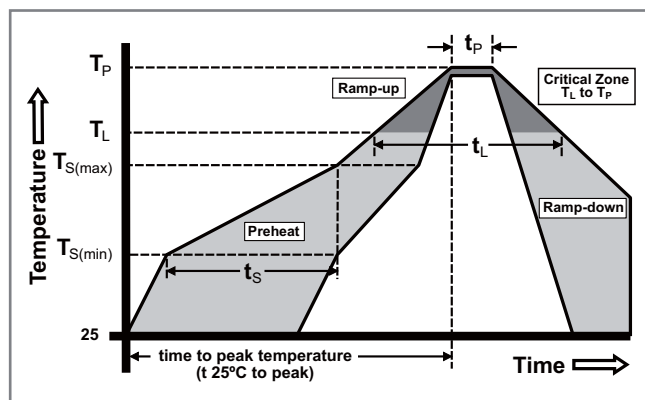

Wave Soldering	260°C, 10 seconds max.
----------------	------------------------

Product Characteristics

Materials	Body: Epoxy Substrate Terminations, RoHS Compliant Device (429L): 100% Tin over Nickel over Copper Element Cover Coat: Conformal Coating NOTE: Do not use alcohol-based cleaners or solvents with 429 Series Thin-Film Fuses as it may damage the coating.
Operating Temperature	– 55°C to 90°C. Consult temperature derating chart. For operation above 90°C contact Littelfuse.
Thermal Shock	Withstands 5 cycles of – 55°C to 125°C

Humidity	MIL-STD-202F, Method 103B Condition D
Vibration	Withstands 10 – 55 Hz per MIL-STD-202F, Method 201A and 10-2000 Hz at 20 G's per MIL-STD-202F, Method 204D, Condition D.
Insulation Resistance (After Opening)	Greater than 10,000 ohms
Resistance to Soldering Heat	MIL-STD-202G, Method 210F, Condition D

Dimensions

RECOMMENDED PAD LAYOUTS

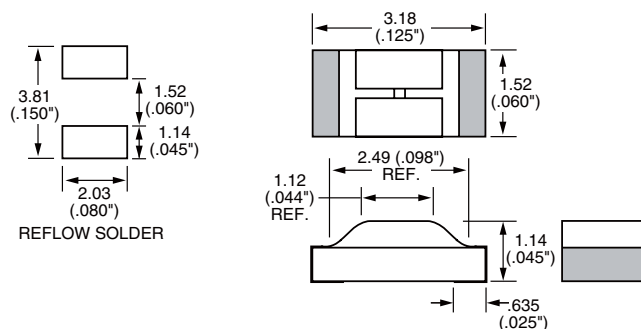

Part Marking System

Series	Marking Code
429L	7

Part Numbering System

0429 007. WRM L HF

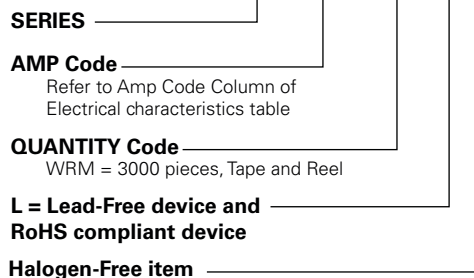

Packaging

Packaging Option	Packaging Specification	Quantity	Quantity & Packaging Code
Tape & Reel – 8mm tape	EIA RS-481-1 (IEC 286, part 3)	3000	WRM

RoHS  **HF 468 Series Fuse**

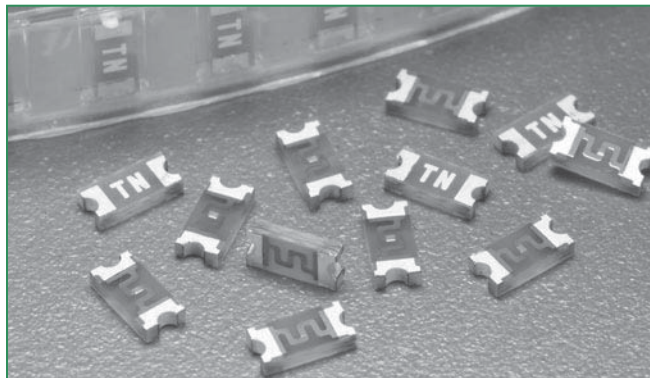

Description

The 468 Series Time-Lag (Slo-Blo®) SMF is a small (1206 size) thin-film device designed for secondary protection of circuits used in space constrained applications such as hand-held portable electronic devices.

This series is 100% lead-free and meets the requirements of the RoHS directive. New Halogen-Free 468 Series fuses are available—to order use the “HF” suffix. See Part Numbering section for additional information.

Features



- Complies with electronic industry environmental standards for lead reduction.
- Product is compatible with lead-free solders and higher temperature profiles.
- Time delay feature withstands high inrush currents and prevents nuisance openings.
- Package is visually distinct from fast-acting version for easy identification.
- Top side marking allows visual verification of amperage rating.

Applications

Secondary protection for space constrained applications:

- Cell phones
- Battery packs
- Digital cameras
- DVD players
- Hard disk drives.



Agency Approvals

AGENCY	AGENCY FILE NUMBER	AMPERE RANGE
	E10480	500MA - 3A
	LR29862	500MA - 3A

Electrical Characteristics for Series

% of Ampere Rating	Opening Time at 25°C
100%	4 hours, Minimum
200%	1 sec., Min.; 120 sec., Max.
300%	0.05 sec., Min.; 1.5 sec., Max
800%	0.0015 sec., Min.; .05 sec., Max.

Electrical Specifications by Item

Ampere Rating (A)	Amp Code	Max Voltage Rating (V)	Interrupting Rating	Nominal Cold Resistance (Ohms)	Nominal Melting I ² t (A ² sec)	Nom Voltage Drop (mV)	Nom Power Dissipation (W)	Agency Approvals	
									
0.50	.500	63	50 amperes @63 VAC/VDC	0.27000	0.0310	156.77	0.0784	x	x
1.00	001.	63		0.08250	0.1270	94.70	0.0947	x	x
1.50	01.5	63		0.04750	0.2880	82.32	0.1235	x	x
2.00	002.	63	35 amperes @63 VAC 50 amperes @63 VDC	0.03240	0.5060	77.27	0.1545	x	x
2.50	02.5	63		0.02240	1.0110	73.92	0.1848	x	x
3.00	003.	32	50 amperes @32 VAC/VDC	0.01950	1.2700	72.95	0.2189	x	x

1. Measured at 10% of rated current, 25°C.
 2. Measured at rated voltage.

Temperature Derating Curve

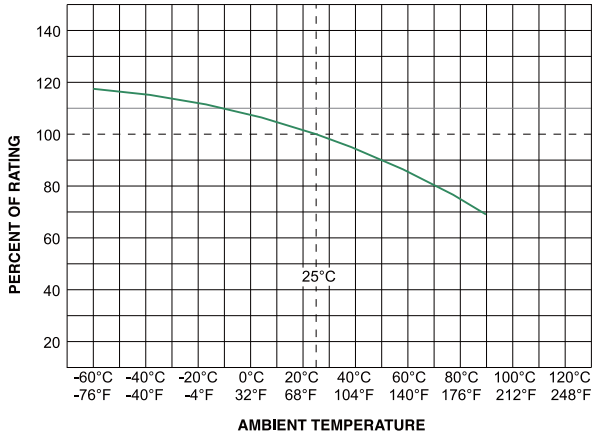

Note:

- Derating depicted in this curve is in addition to the standard derating of 25% for continuous operation.

Example:

For continuous operation at 70 degrees celsius, the fuse should be derated as follows:

$$I = (0.75)(0.80)I_{RAT} = (0.60)I_{RAT}$$

Average Time Current Curves

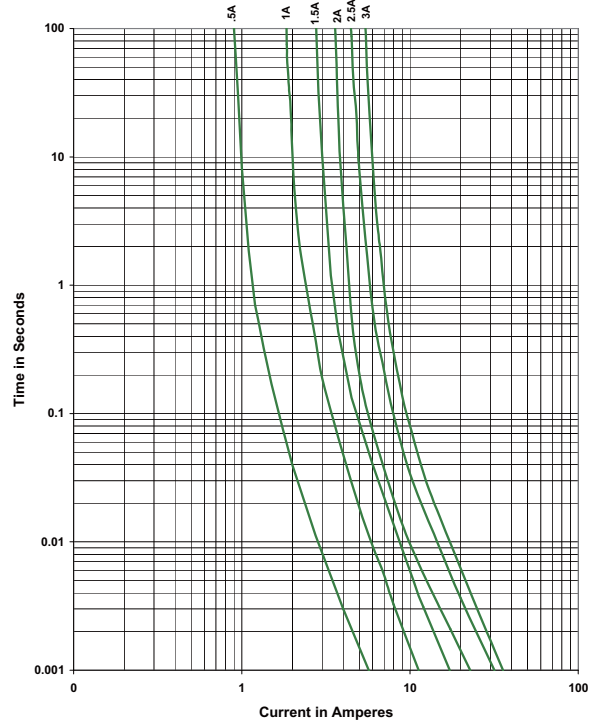

Soldering Parameters

Reflow Condition		Pb – Free assembly
Pre Heat	- Temperature Min ($T_{s(min)}$)	150°C
	- Temperature Max ($T_{s(max)}$)	200°C
	- Time (Min to Max) (t_s)	60 – 180 secs
Average ramp up rate (Liquidus Temp (T_L) to peak)		5°C/second max
$T_{s(max)}$ to T_L - Ramp-up Rate		5°C/second max
Reflow	- Temperature (T_L) (Liquidus)	217°C
	- Temperature (t_L)	60 – 150 seconds
Peak Temperature (T_p)		250 ^{+0/-5} °C
Time within 5°C of actual peak Temperature (t_p)		20 – 40 seconds
Ramp-down Rate		5°C/second max
Time 25°C to peak Temperature (T_p)		8 minutes Max.
Do not exceed		260°C

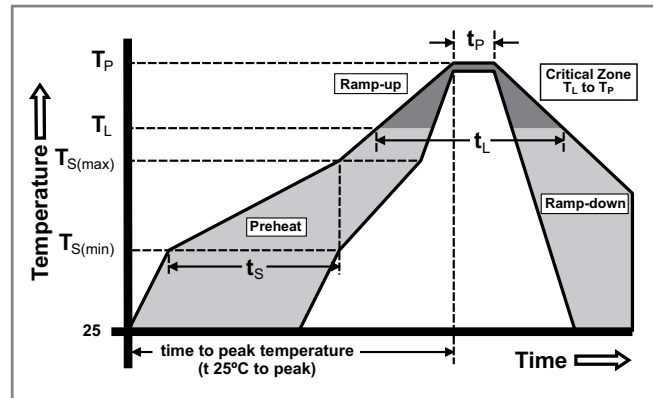

Wave Soldering

260°C, 10 seconds max.

Product Characteristics

Materials	Body: Epoxy Substrate Terminations: 100% Tin Element Cover Coat: Conformal Coating
Operating Temperature	-55°C to 90°C. Consult temperature derating curve chart. For operation above 90°C please contact Littelfuse
Thermal Shock	Withstands 5 cycles of - 50°C to 125°C
Humidity	MIL-STD-202F, Method 103B, Condition D

Vibration	Withstands 10-55 Hz per MIL-STD-202F, Method 201A and 10-2000 Hz at 20 G's per MIL-STD-202F, Method 204D, Condition D
Insulation Resistance (After Opening)	Greater than 10,000 ohms.
Resistance to Soldering Heat	MIL-STD-202G, Method 210F, Condition D

Dimensions

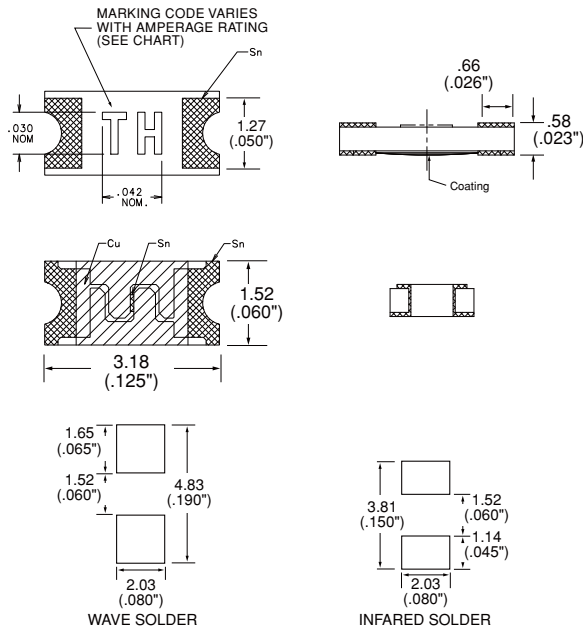

Part Marking System

Amp Code	Marking Code
.500	TF
001.	TH
01.5	TK
002.	TN
02.5	TO
003.	TP

Part Numbering System

0468002.NRHF

SERIES

AMP Code

The dot is positioned before the Packaging Suffix with whole ratings and within the numbering sequence for fractional ratings. Refer to Amp Code column in the Electrical Specifications table.

PACKAGING Code

NR = Tape and Reel, 5000 pcs

'HF' SUFFIX

HALOGEN FREE ITEM

Example:
1.5 amp product is 0468**01.5**NRHF (2 amp product shown above).



Packaging

Packaging Option	Packaging Specification	Quantity	Quantity & Packaging Code
Tape & Reel – 8mm tape	EIA RS-481-1 (IEC 286, part 3)	5000	NR

RoHS  **HF 467 Series Fuse**



Agency Approvals

AGENCY	AGENCY FILE NUMBER	AMPERE RANGE
	E10480	250MA - 5A
	LR29862	250MA - 5A

Electrical Characteristics for Series

% of Ampere Rating	Opening Time at 25°C
100%	4 hours, Minimum
200%	5 sec., Maximum
300%	0.2 sec., Maximum

Description

The 467 Series Fast-Acting SMF is an ultra small (0603 size) thin-film device designed for secondary protection of circuits used in space constrained applications such as hand-held portable electronic devices. This series is 100% lead-free and meets the requirements of the RoHS directive. New Halogen-Free 467 Series fuses are available—to order use the “HF” suffix. See Part Numbering section for additional information..

Features



- Compatible with lead-free solders and higher temperature profiles.
- High performance materials provide improved performance in elevated ambient temperature applications.
- Marked on top surface with code to allow amp rating identification without testing.
- Low profile for height sensitive applications.
- Flat top surface for pick-and-place operations.
- Element covering material is resistant to industry standard cleaning operations.
- Mounting pad and electrical performance is identical to Littelfuse 431 and 434 Series products.
- Alloy based element construction provides superior inrush withstand characteristics (I2t) over ceramic or glass based 0603 fuse products.

Applications

Secondary protection for space constrained applications:

- Cell phones
- Digital cameras
- Hard disk drives
- Battery packs
- DVD players

Electrical Specifications by Item

Ampere Rating (A)	Amp Code	Max Voltage Rating (V)	Interrupting Rating	Nominal Cold Resistance (Ohms)	Nominal Melting I²t (A²sec)	Nom Voltage Drop (mV)	Nom Power Dissipation (W)	Agency Approvals	
									
0.250	.250	32	50A @32V AC/DC	0.5450	0.0030	158.56	0.0396	x	x
0.375	.375	32		0.2900	0.0053	128.03	0.0480	x	x
0.500	.500	32		0.1870	0.0087	115.71	0.0579	x	x
0.750	.750	32		0.1170	0.0171	107.33	0.0805	x	x
1.00	001.	32		0.0710	0.0212	89.10	0.0891	x	x
1.25	1.25	32	35A @32V AC/DC	0.0530	0.0518	84.32	0.1054	x	x
1.50	01.5	32		0.0410	0.0766	81.14	0.1217	x	x
1.75	1.75	32		0.0320	0.0903	78.75	0.1378	x	x
2.00	002.	32		0.0300	0.1103	78.22	0.1564	x	x
2.50	02.5	32		0.0220	0.1440	76.10	0.1903	x	x
3.00	003.	32		0.0180	0.2403	75.04	0.2251	x	x
3.50	03.5	32		0.0150	0.4306	74.25	0.2599	x	x
4.00	004.	32		0.0130	0.5760	73.72	0.2949	x	x
5.00	005.	32		0.0090	0.9000	72.71	0.3635	x	x

1. Measured at 10% of rated current, 25°C. 2. Measured at rated voltage.
 © 2009 Littelfuse, Inc.

Specifications are subject to change without notice.
 Please refer to www.littelfuse.com/series/467.html for current information.

Temperature Derating Curve

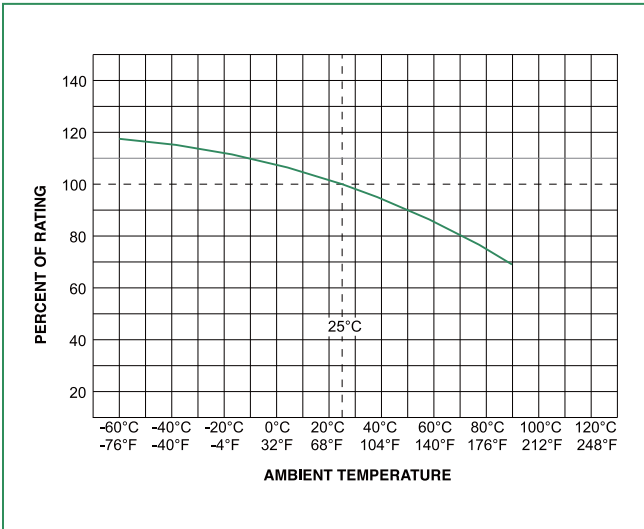

Note:

- Derating depicted in this curve is in addition to the standard derating of 25% for continuous operation.

Example:

For continuous operation at 70 degrees celsius, the fuse should be derated as follows:

$$I = (0.75)(0.80)I_{RAT} = (0.60)I_{RAT}$$

Average Time Current Curves

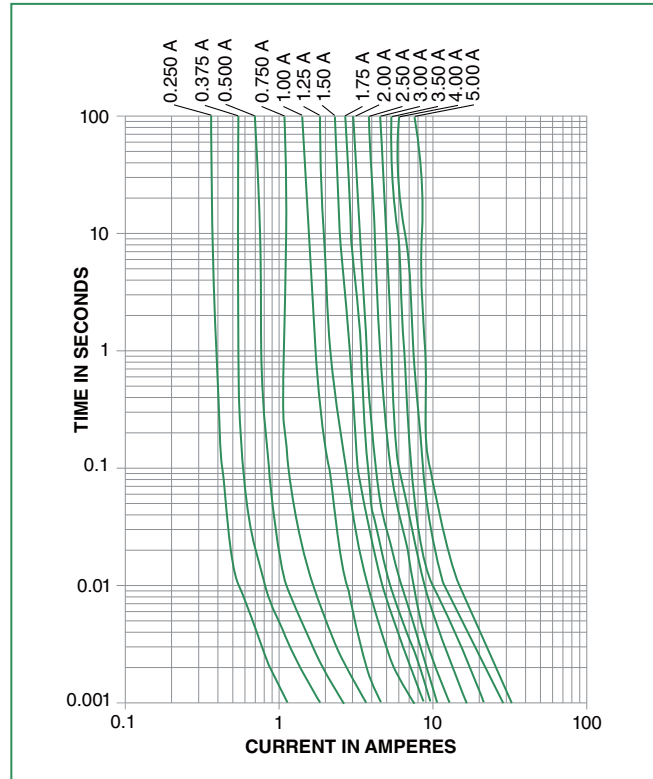

Soldering Parameters

Reflow Condition		Pb – Free assembly
Pre Heat	- Temperature Min ($T_{s(min)}$)	150°C
	- Temperature Max ($T_{s(max)}$)	200°C
	- Time (Min to Max) (t_s)	60 – 180 secs
Average ramp up rate (Liquidus Temp (T_L) to peak)		5°C/second max
$T_{s(max)}$ to T_L - Ramp-up Rate		5°C/second max
Reflow	- Temperature (T_L) (Liquidus)	217°C
	- Temperature (t_L)	60 – 150 seconds
Peak Temperature (T_p)		250 ^{+0/-5} °C
Time within 5°C of actual peak Temperature (t_p)		20 – 40 seconds
Ramp-down Rate		5°C/second max
Time 25°C to peak Temperature (T_p)		8 minutes Max.
Do not exceed		260°C

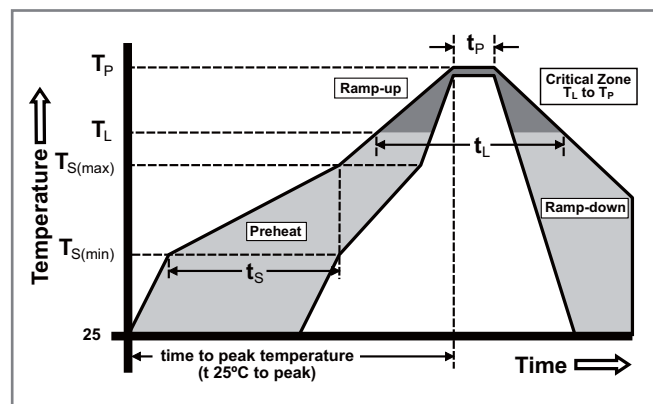

Wave Soldering	260°C, 10 seconds max.
----------------	------------------------

Product Characteristics

Materials	Body: Advanced High Temperature Substrate Terminations: 100% Tin over Nickel over Copper Element Cover Coat: Conformal Coating
Operating Temperature	- 55°C to 90°C. Consult temperature derating curve chart. For operation above 90°C contact Littelfuse.
Humidity	MIL-STD-202F, Method 103B, Condition D

Thermal Shock	Withstands 5 cycles of - 55°C to 125°C
Vibration	Per MIL-STD-202F
Insulation Resistance (After Opening)	Greater than 10,000 ohms.
Resistance to Soldering Heat	MIL-STD-202G, Method 210F, Condition D

Dimensions

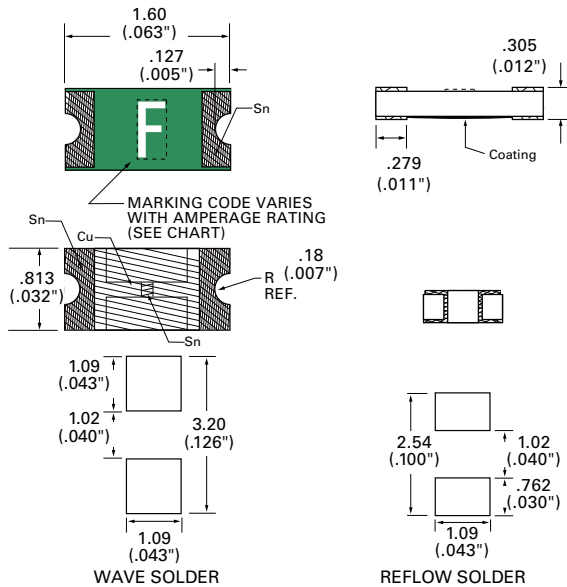

Part Marking System

Amp Code	Marking Code
.250	D
.375	E
.500	F
.750	G
001.	H
1.25	J
01.5	K
1.75	L
002.	N
02.5	O
003.	P
03.5	R
004.	S
005.	T

Part Numbering System

0467002.NRHF

SERIES

AMP Code

The dot is positioned before the Packaging Suffix with whole ratings and within the numbering sequence for fractional ratings. Refer to Amp Code column in the Electrical Specifications table.

PACKAGING Code

NR = Tape and Reel, 5000 pcs

'HF' SUFFIX

HALOGEN FREE ITEM

Example:

1.5 amp product is 0467**1.5**NRHF (2 amp product shown above).

Packaging

Packaging Option	Packaging Specification	Quantity	Quantity & Packaging Code
8mm Tape and Reel	EIA RS-481-2 (IEC 286, part 3)	5000	NR

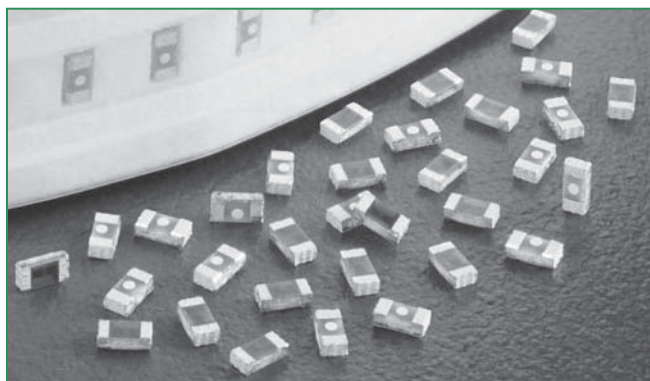
RoHS  HF 435 Series Fuse

Description



The 435 Series are fast-acting surface mount thin-film fuses. Their ultra-small size (0402 size) makes them ideal for secondary protection of circuits used in space constrained applications such as hand-held portable electronic devices.

This series is 100% lead-free and meet the requirements of the RoHS directive. New Halogen-Free 435 Series fuses are available—to order use the “HF” suffix. See Part Numbering section for additional information.

Features

- 35A interrupt rating at 32VDC
- Small size with current ratings of 0.25 to 5.0 amperes
- RoHS compliant, lead-free and halogen-free
- Maximum protection of sensitive circuits as fuses are designed to open consistently in <5sec at 200% overload.
- Enhanced Breaking Capacity, High I²t

Agency Approvals

AGENCY	AGENCY FILE NUMBER	AMPERE RANGE
	E10480	0.250 - 5.0A
	LR 29862	0.250 - 5.0A

Electrical Characteristics for Series



% of Ampere Rating	Ampere Rating	Opening Time at 25°C
100%	0.250A - 5A	4 hours, Minimum
200%	0.375A - 5A	5 secs., Maximum
300%	0.250A	5 secs., Maximum
300%	0.375A - 5A	0.2 sec., Maximum

Applications

Secondary protection for space constrained applications such as:

- Cell phones
- Battery packs
- Digital cameras
- DVD players
- Hard disk drives.

Electrical Specifications by Item

Ampere Rating (A)	Amp Code	Max Voltage Rating (V)	Interrupting Rating	Nominal Cold Resistance (Ohms)	Nominal Melting I ² t (A ² sec)	Nom Voltage Drop (mV)	Nom Power Dissipation (W)	Agency Approvals	
									
0.250	.250	32	35A @32V DC	0.2265	0.0025	60.67	0.01517	x	x
0.375	.375	32		0.1930	0.0035	84.64	0.03174	x	x
0.500	.500	32		0.1600	0.0053	93.35	0.04668	x	x
0.750	.750	32		0.1050	0.0120	101.84	0.07638	x	x
1.00	001.	32		0.0730	0.0200	87.45	0.08745	x	x
1.25	1.25	32		0.0600	0.0350	96.37	0.12046	x	x
1.50	01.5	32		0.0470	0.0560	86.70	0.13005	x	x
1.75	1.75	32		0.0390	0.0750	81.13	0.14198	x	x
2.00	002.	32		0.0300	0.1000	70.62	0.14120	x	x
2.50	02.5	32		0.0185	0.1560	55.25	0.13813	x	x
3.00	003.	32		0.0165	0.2032	60.58	0.18740	x	x
3.50	03.5	32		0.0135	0.3017	57.84	0.20244	x	x
4.00	004.	32		0.0115	0.3084	57.00	0.22800	x	x
5.00	005.	32		0.0085	0.5310	52.44	0.26220	x	x

1. Measured at 10% of rated current, 25°C.
 2. Measured at rated voltage.

Temperature Derating Curve

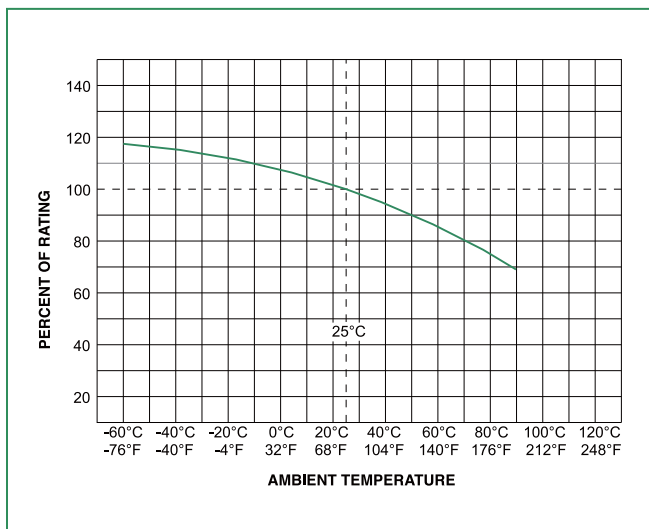

Note:

- Derating depicted in this curve is in addition to the standard derating of 25% for continuous operation.

Example:

For continuous operation at 70 degrees celsius, the fuse should be derated as follows:

$$I = (0.75)(0.80)I_{RAT} = (0.60)I_{RAT}$$

Average Time Current Curves

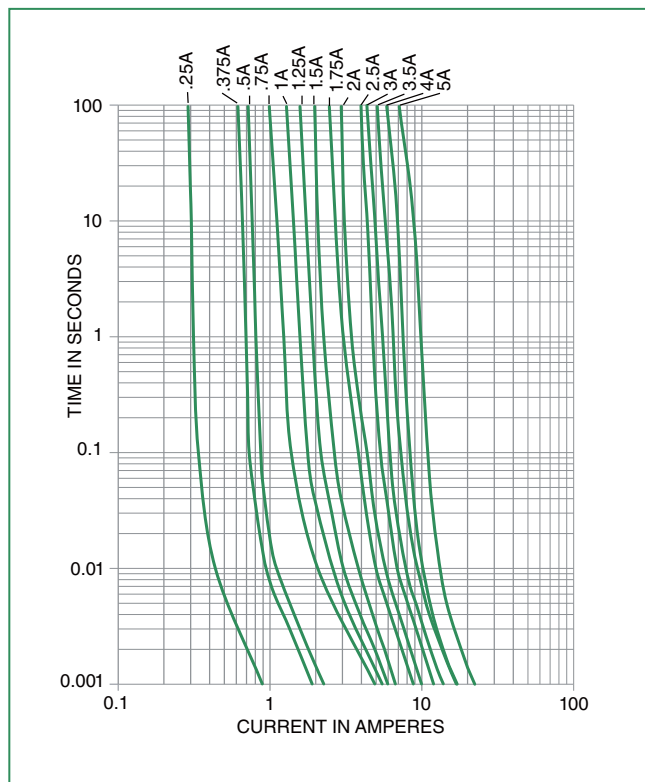

Soldering Parameters

Reflow Condition		Pb – Free assembly
Pre Heat	- Temperature Min ($T_{s(min)}$)	150°C
	- Temperature Max ($T_{s(max)}$)	200°C
	- Time (Min to Max) (t_s)	60 – 120 secs
Average ramp up rate (Liquidus Temp (T_L) to peak)		5°C/second max
$T_{s(max)}$ to T_L - Ramp-up Rate		5°C/second max
Reflow	- Temperature (T_L) (Liquidus)	217°C
	- Temperature (t_L)	60 – 150 seconds
Peak Temperature (T_p)		250 ^{+0/-5} °C
Time within 5°C of actual peak Temperature (t_p)		20 – 40 seconds
Ramp-down Rate		5°C/second max
Time 25°C to peak Temperature (T_p)		8 minutes Max.
Do not exceed		260°C

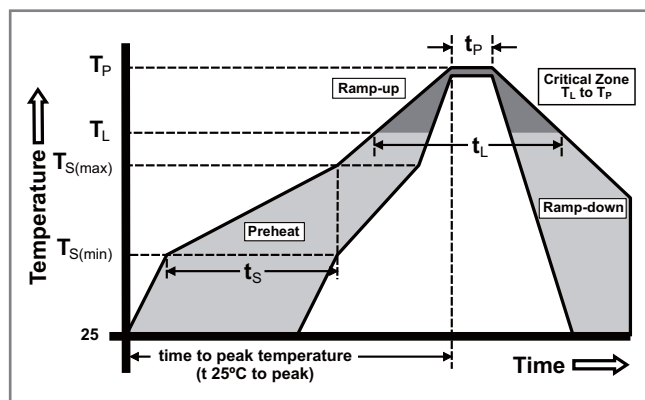

Wave Soldering	260°C, 10 seconds max.
----------------	------------------------

Product Characteristics

Materials	Body: Epoxy / Glass Substrate; Parts with 'HF' suffix: Halogen Free Epoxy / Glass Terminations: 100% Tin over Nickel over Copper Device Weight: 0.316mg
Terminal Strength	MIL-STD-202F, Method 211A, Test Condition A
Insulation Resistance	After Opening: Greater than 10,000Ohms

Operating Temperature	-55°C to 90°C. Consult temperature derating curve chart. For operation above 90°C please contact Littelfuse.
Thermal Shock	Withstands 5 cycles of -55°C to 125°C
Vibration	MIL-STD-202F

Dimensions

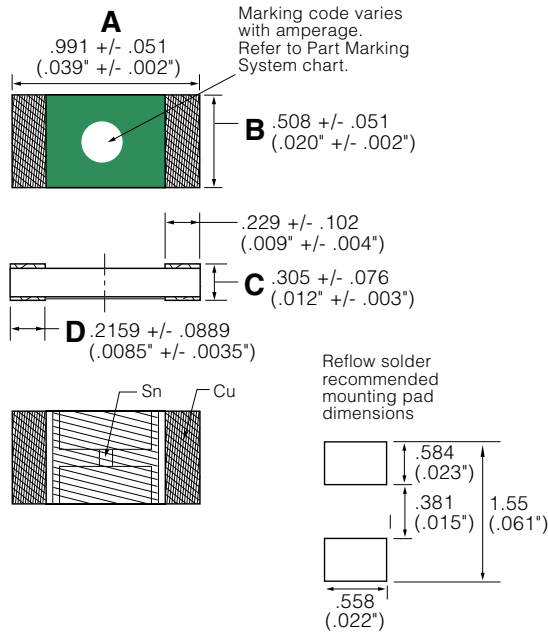

	A	B	C	D
inch min	0.037	0.018	0.009	0.005
inch max	0.041	0.022	0.015	0.012
mm min	0.94	0.457	0.229	0.127
mm max	1.04	0.559	0.381	0.305

Part Marking System

Amp Code	Marking Code
.250	
.375	
.500	
.750	
001.	
1.25	
01.5	
1.75	
002.	
02.5	
003.	
03.5	
004.	
005.	

Part Numbering System

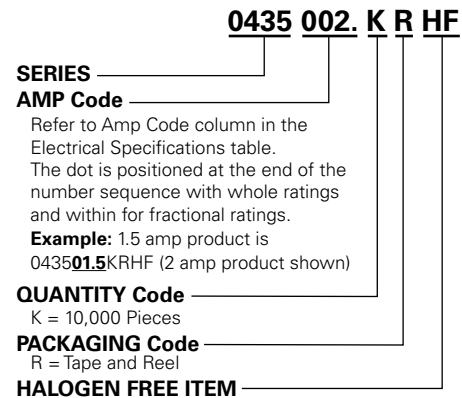

Packaging

Packaging Option	Packaging Specification	Quantity	Quantity & Packaging Code
8mm Tape and Reel	EIA RS-481-2 (IEC 286, part 3)	10000	KR

RoHS  **448 Series Fuse**

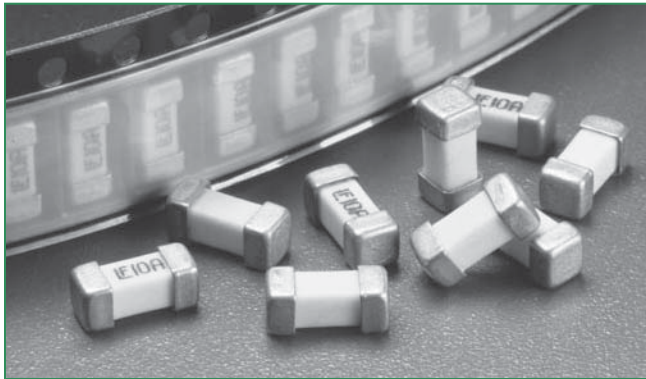



Description

The lead-free Nano² SMF Fuse is a very small, square surface mount fuse that is RoHS compliant and 100% lead-free. This product is fully compatible with lead-free solder alloys and higher temperature profiles associated with lead-free assembly.

Features

- Lead-free
- Very fast acting
- Small size
- Wide range of current rating available (62mA to 15A)
- Wide operating temperature range
- Low temperature de-rating

Agency Approvals

AGENCY	AGENCY FILE NUMBER	AMPERE RANGE
	E10480	62mA - 15A
	LR29862	62mA - 15A
	NBK030205	1A - 10A

Electrical Characteristics for Series



% of Ampere Rating	Ampere Rating	Opening Time
100%	1/16 –15	4 hours, Minimum
200%	1/16 –10	5 sec., Maximum
	12 –15	20 sec., Maximum

Applications

- Notebook PC
- LCD/PDP TV
- LCD monitor
- LCD/PDP panel
- LCD backlight inverter
- Portable DVD player
- Power supply
- Networking
- PC server
- Cooling fan system
- Storage system
- Telecom system
- Wireless basestation
- White goods
- Game console
- Office Automation equipment
- Battery charging circuit protection
- Industrial equipment
- Medical equipment
- Automotive

448 Series

Electrical Specifications by Item

Ampere Rating (A)	Amp Code	Max Voltage Rating (V)	Interrupting Rating	Nominal Cold Resistance (Ohms)	Nominal Melting I ² t (A ² sec)	Agency Approvals		
								
0.062	.062	125	50 amperes @125 VAC/VDC 300 amperes @32 VDC PSE: 100 amperes @100VAC	5.50	0.00023	x	x	
0.080	.080	125		4.42	0.00043	x	x	
0.100	.100	125		2.90	0.00082	x	x	
0.125	.125	125		2.58	0.00130	x	x	
0.160	.160	125		1.76	0.00280	x	x	
0.200	.200	125		1.40	0.00380	x	x	
0.250	.250	125		1.05	0.01520	x	x	
0.315	.315	125		0.7900	0.02650	x	x	
0.375	.375	125		0.7300	0.02400	x	x	
0.400	.400	125		0.4895	0.04160	x	x	
0.500	.500	125		0.3800	0.10000	x	x	
0.630	.630	125		0.2821	0.121	x	x	
0.750	.750	125		0.2475	0.206	x	x	
0.800	.800	125		0.1907	0.272	x	x	
1.00	001.	125		0.08630	0.441	x	x	x
1.25	1.25	125		0.06619	0.900	x	x	x
1.50	01.5	125		0.06514	0.900	x	x	x
1.60	01.6	125		0.06261	1.122	x	x	x
2.00	002.	125		0.03529	0.812	x	x	x
2.50	02.5	125		0.02934	1.156	x	x	x
3.00	003.	125		0.02445	1.720	x	x	x
3.15	3.15	125		0.02300	1.810	x	x	x
3.50	03.5	125		0.02100	2.300	x	x	x
4.00	004.	125		0.01577	3.970	x	x	x
5.00	005.	125	0.01531	4.490	x	x	x	
6.30	06.3	125	0.01044	12.10	x	x	x	
7.00	007.	125	0.00900	13.92	x	x	x	
8.00	008.	125	0.00780	18.33	x	x	x	
10.00	010.	125	35 amperes @125 VAC 50 amperes @125 VDC 300 amperes @32 VDC PSE: 100 amperes @100VAC	0.00700	28.00	x	x	x
12.00	012.	65	50 amperes @65 VAC/VDC 300 amperes @24 VDC	0.00533	47.59	x	x	
15.00	015.	65		0.00394	96.10	x	x	

Notes:
- I²t calculated at 8ms.
- Resistance is measured at 10% of rated current, 25°C

Temperature Derating Curve

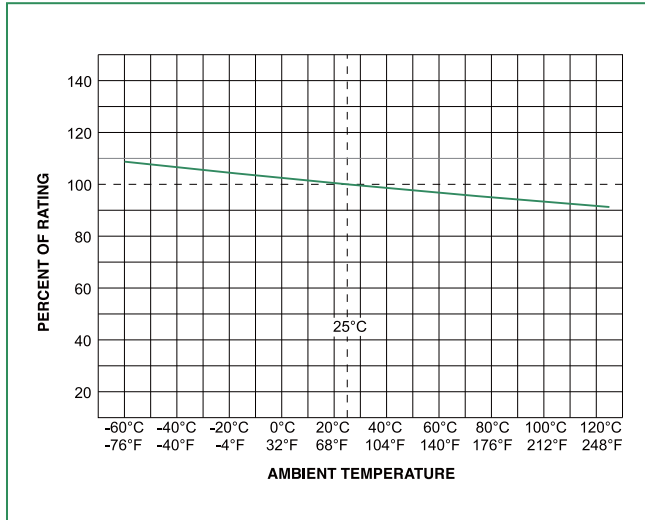

Note:

- Derating depicted in this curve is in addition to the standard derating of 25% for continuous operation.

Average Time Current Curves

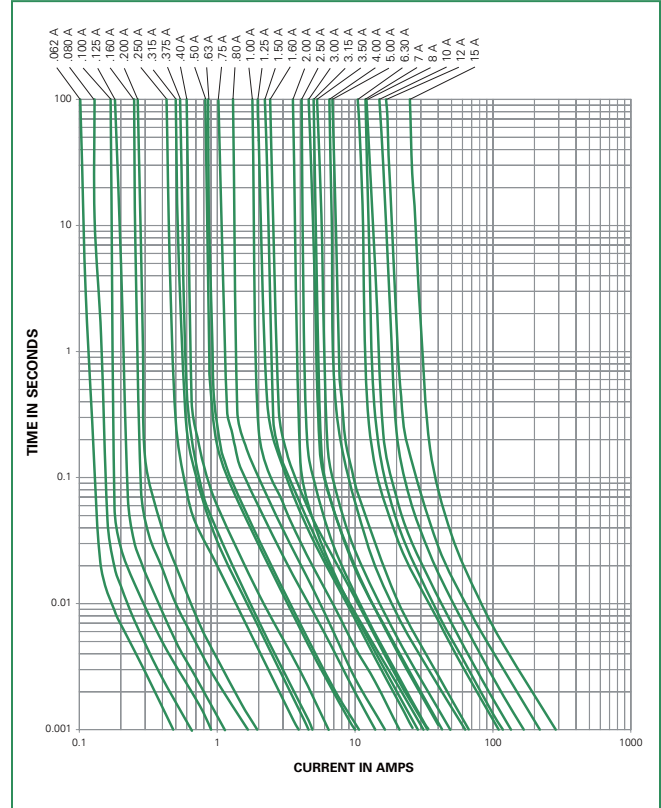

Soldering Parameters

Reflow Condition		Pb – Free assembly
Pre Heat	- Temperature Min ($T_{s(min)}$)	150°C
	- Temperature Max ($T_{s(max)}$)	200°C
	- Time (Min to Max) (t_s)	60 – 120 secs
Average ramp up rate (Liquidus Temp (T_L) to peak)		5°C/second max.
$T_{s(max)}$ to T_L - Ramp-up Rate		5°C/second max.
Reflow	- Temperature (T_L) (Liquidus)	217°C
	- Temperature (t_L)	60 – 90 seconds
Peak Temperature (T_p)		250 ^{+0/-5} °C
Time within 5°C of actual peak Temperature (t_p)		20 – 40 seconds
Ramp-down Rate		5°C/second max.
Time 25°C to peak Temperature (T_p)		8 minutes max.
Do not exceed		260°C
Wave Soldering Parameters		260°C Peak Temperature, 10 seconds max.

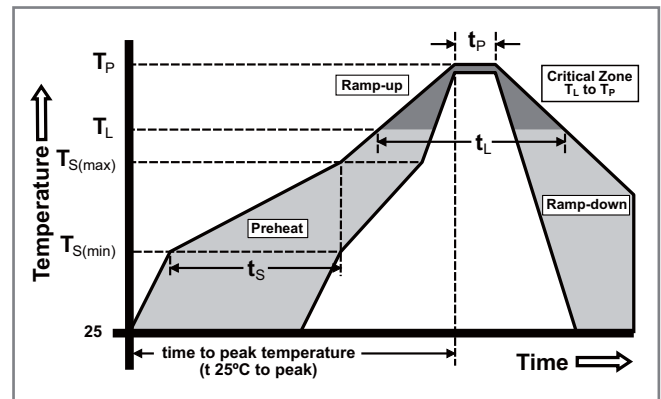

Product Characteristics

Materials	Body: Ceramic Terminations: Gold-plated Caps
Product Marking	Brand, Amperage Rating
Operating Temperature	-55°C to 125°C
Moisture Sensitivity Level	Level 1, J-STD-020C
Solderability	MIL-STD-202, Method 208
Insulation Resistance (after Opening)	MIL-STD-202, Method 302, Test Condition A (10,000 ohms minimum)

Thermal Shock	MIL-STD-202, Method 107, Test Condition B, 5 cycles, -65°C to 125°C, 15 minutes @ each extreme
Mechanical Shock	MIL-STD-202, Method 213, Test I: Deenergized. 100G's pk amplitude, sawtooth wave 6ms duration, 3 cycles XYZ+xyz = 18 shocks
Vibration	MIL-STD-202, Method 201: 0.03" amplitude, 10-55 Hz in 1 min. 2hrs each XYZ=6hrs
Moisture Resistance	MIL-STD-202, Method 106, 10 cycles
Salt Spray	MIL-STD-202, Method 101, Test Condition B (48hrs)
Resistance to Soldering Heat	MIL-STD-202, Method 210, Test condition B (10 sec at 260°C)

Dimensions

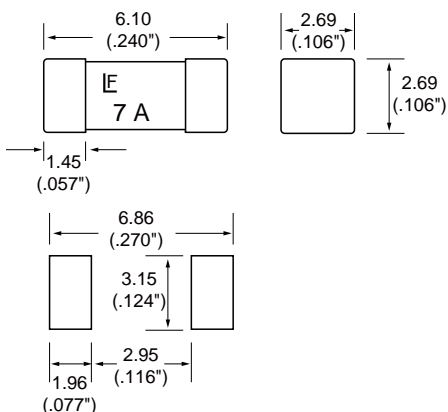

Recommended pad layout

Part Numbering System

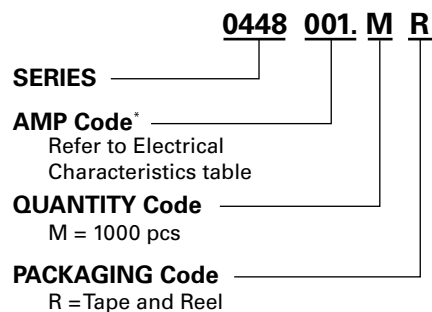

***Example:**
1.5 amp product is 044801.5MR
(1 amp product shown above).

Packaging

Packaging Option	Packaging Specification	Quantity	Quantity & Packaging Code
12mm Tape and Reel	EIA RS-481-1 (IEC 286, part 3)	1000	MR

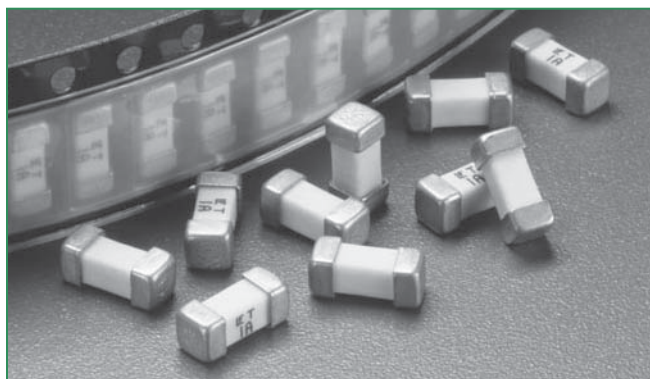
RoHS (Pb) 449 Series Fuse

Agency Approvals

AGENCY	AGENCY FILE NUMBER	AMPERE RANGE
	E10480	375mA - 5A
	NBK030205	1A - 5A

Electrical Characteristics for Series

% of Ampere Rating	Opening Time
100%	4 hours, Minimum
200%	1 sec., Min.; 60 sec., Max.
300%	0.2 sec., Min.; 3 sec., Max
800%	0.02 sec., Min.; 0.1 sec., Max.

Electrical Specifications by Item

Ampere Rating (A)	Amp Code	Max Voltage Rating (V)	Interrupting Rating	Nominal Cold Resistance (Ohms)	Nominal Melting I ² t (A ² sec)	Agency Approvals	
0.375	0.375	125	50 amperes @125 VAC/ VDC PSE: 100 amperes @100 VAC	1.5130	0.088	x	
0.500	0.500	125		0.7633	0.258	x	
0.750	0.750	125		0.4080	0.847	x	
1.00	001.	125		0.2516	1.76	x	x
1.50	01.5	125		0.1186	4.70	x	x
2.00	002.	125		0.0708	6.76	x	x
2.50	02.5	125		0.0400	13.18	x	x
3.00	003.	125		0.0352	19.55	x	x
3.50	03.5	125		0.0261	32.70	x	x
4.00	004.	125		0.0227	40.80	x	x
5.00	005.	125	0.0171	59.59	x	x	

Notes: - I²t calculated at 8ms. Resistance is measured at 10% of rated current, 25°C

Description

The lead free NANO² Slo-Blo® fuse is RoHS compliant and 100% lead-free. This product is fully compatible with lead-free solder alloys and higher temperature profiles associated with lead-free assembly. The Slo-Blo® design has enhanced inrush withstand characteristics over the NANO² Fast-Acting Fuse. The unique time delay feature of this fuse design helps solve the problem of nuisance "opening" by accommodating inrush currents that normally cause a fast-acting fuse to open.

Features

- Lead-free
- Slo-Blo®
- Small size
- Wide range of current ratings available
- Wide operating temperature range
- Low temperature de-rating

Applications

Secondary protection for space constrained applications:

- Notebook PC
- LCD/PDP TV
- LCD monitor
- LCD/PDP panel
- LCD backlight inverter
- Portable DVD player
- Power supply
- Networking
- PC server
- Cooling fan system
- Storage system
- Telecom system
- Wireless basestation
- White goods
- Game console
- Office Automation equipment
- Battery charging circuit protection
- Industrial equipment
- Medical equipment
- Automotive

Temperature Derating Curve

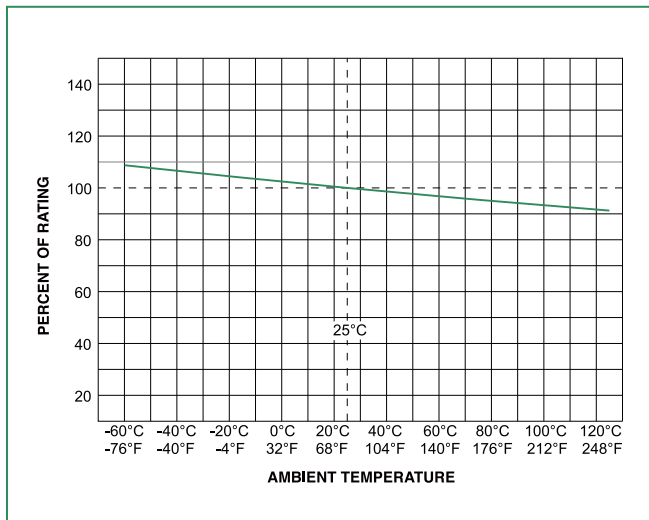

Note:

1. Derating depicted in this curve is in addition to the standard derating of 25% for continuous operation.

Average Time Current Curves

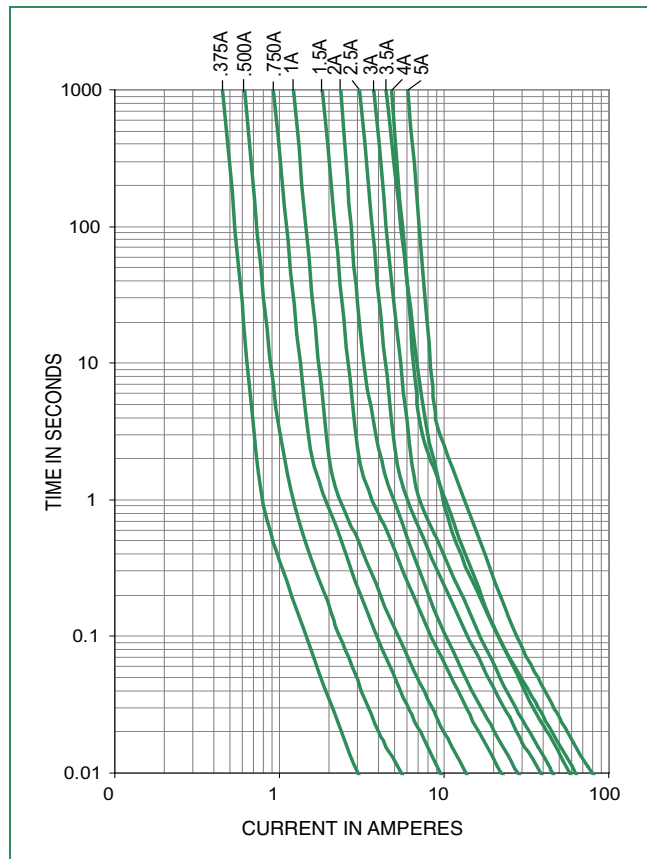

Soldering Parameters

Reflow Condition		Pb – Free assembly
Pre Heat	- Temperature Min ($T_{s(min)}$)	150°C
	- Temperature Max ($T_{s(max)}$)	200°C
	- Time (Min to Max) (t_s)	60 – 120 secs
Average ramp up rate (Liquidus Temp (T_L) to peak)		3°C/second max.
$T_{s(max)}$ to T_L - Ramp-up Rate		3°C/second max.
Reflow	- Temperature (T_L) (Liquidus)	217°C
	- Temperature (t_l)	60 – 90 seconds
Peak Temperature (T_p)		250 ^{+0/-5} °C
Time within 5°C of actual peak Temperature (t_p)		20 – 40 seconds
Ramp-down Rate		5°C/second max.
Time 25°C to peak Temperature (T_p)		8 minutes max.
Do not exceed		260°C
Wave Soldering Parameters		260°C Peak Temperature, 3 seconds max.

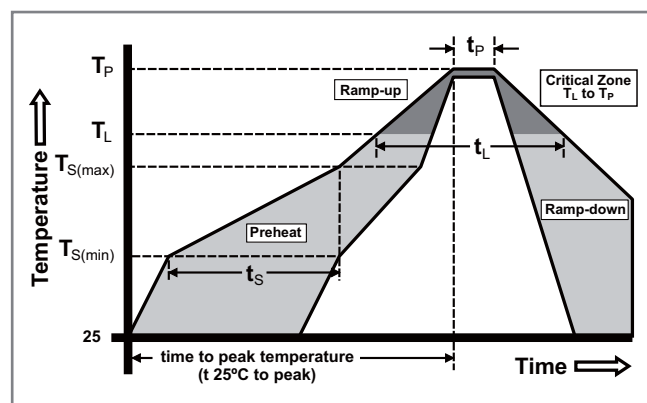

Product Characteristics

Materials	Body: Ceramic Terminations: Gold-plated Caps
Product Marking	Brand, Amperage Rating
Operating Temperature	-55°C to 125°C
Moisture Sensitivity Level	Level 1, J-STD-020C
Solderability	MIL-STD-202, Method 208
Insulation Resistance (after Opening)	MIL-STD-202, Method 302, Test Condition A (10,000 ohms minimum)

Thermal Shock	MIL-STD-202, Method 107, Test Condition B, 5 cycles, -65°C to 125°C, 15 minutes @ each extreme
Mechanical Shock	MIL-STD-202, Method 213, Test I: Deenergized. 100G's pk amplitude, sawtooth wave 6ms duration, 3 cycles XYZ+xyz = 18 shocks
Vibration	MIL-STD-202, Method 201: 0.03" amplitude, 10-55 Hz in 1 min. 2hrs each XYZ=6hrs
Moisture Resistance	MIL-STD-202, Method 106, 10 cycles
Salt Spray	MIL-STD-202, Method 101, Test Condition B (48hrs)
Resistance to Soldering Heat	MIL-STD-202, Method 210, Test condition B (10 sec at 260°C)

Dimensions

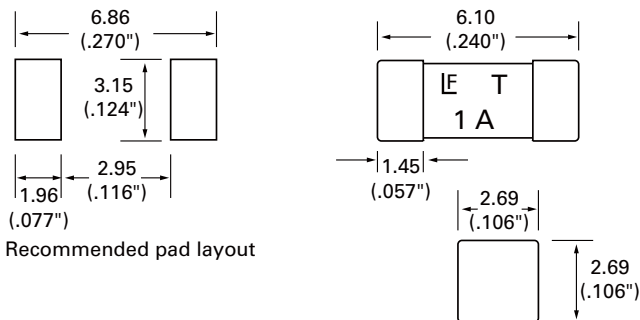

Part Numbering System

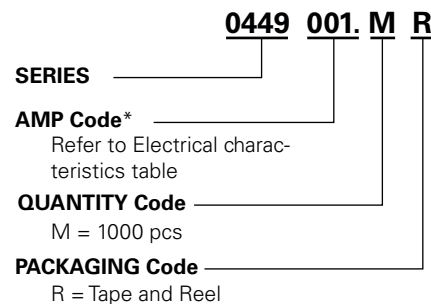

***Example:**
0.375 Amp product is 0449.375MR
(1 amp product shown above).

Packaging

Packaging Option	Packaging Specification	Quantity	Quantity & Packaging Code
12mm Tape and Reel	EIA RS-481-2 (IEC 286, part 3)	1000	MR

RoHS HF **451/453 Series Fuse**



Description

The Nano² SMF Fuse is a very small, Wire-in-Air (WIA) square shape surface mount fuse which is very suitable for the secondary side circuit over-current protection applications and is designed for PCB using surface mount technology.





Features

- Very fast acting
- Small size
- Wide range of current rating available (62mA to 15A)
- Wide operating temperature range
- Low temperature de-rating
- RoHS compliant
- Halogen Free

Applications

- Notebook PC
- LCD/PDP TV
- LCD monitor
- LCD/PDP panel
- LCD backlight inverter
- Portable DVD player
- Power supply
- Networking
- PC server
- Cooling fan system
- Storage system
- Telecom system
- Wireless basestation
- White goods
- Game console
- Office Automation equipment
- Battery charging circuit protection
- Industrial equipment
- Medical equipment
- Automotive

Agency Approvals





AGENCY	AGENCY FILE NUMBER	AMPERE RANGE
	E10480	6.3A - 15A
	LR29862	62mA - 15A
	NBK030205-E10480B NBK101105-E184655	1A - 5A 6.3A - 10A
	E10480	62mA - 5A

Electrical Characteristics for Series

% of Ampere Rating	Ampere Rating	Opening Time
100%	1/16 – 15	4 hours, Minimum
200%	1/16 – 10	5 sec., Maximum
	12 – 15	20 sec., Maximum

451/453 Series

Electrical Specifications by Item

Ampere Rating (A)	Amp Code	Max Voltage Rating (V)	Interrupting Rating	Nominal Cold Resistance (Ohms)	Nominal Melting I ² t (A ² sec)	Agency Approvals			
									
0.062	.062	125	50 amperes @125VAC/VDC 300 amperes @32VDC PSE: 100 amperes @100VAC	5.5000	0.00019		x		x
0.080	.080	125		4.0500	0.00033		x		x
0.100	.100	125		3.1000	0.00138		x		x
0.125	.125	125		1.7000	0.00286		x		x
0.160	.160	125		1.2157	0.0048		x		x
0.200	.200	125		0.8372	0.0089		x		x
0.250	.250	125		0.5765	0.0158		x		x
0.315	.315	125		0.3918	0.0311		x		x
0.375	.375	125		0.6100	0.0425		x		x
0.400	.400	125		0.5600	0.0484		x		x
0.500	.500	125		0.4200	0.0795		x		x
0.630	.630	125		0.3050	0.143		x		x
0.750	.750	125		0.2450	0.185		x		x
0.800	.800	125		0.2120	0.271		x		x
1.00	001.	125		0.1530	0.459		x	x	x
1.25	1.25	125		0.0780	0.664		x	x	x
1.50	01.5	125		0.0630	0.853		x	x	x
1.60	01.6	125		0.0580	1.060		x	x	x
2.00	002.	125		0.0367	0.530		x	x	x
2.50	02.5	125		0.0286	1.029		x	x	x
3.00	003.	125		0.0227	1.650		x	x	x
3.15	3.15	125		0.0215	1.920		x	x	x
3.50	03.5	125		0.0200	2.469		x	x	x
4.00	004.	125		0.0160	3.152		x	x	x
5.00	005.	125	0.0125	5.566		x	x	x	
6.30	06.3	125	0.0096	9.170	x	x	x		
7.00	007.	125	0.0090	10.32	x	x	x		
8.00	008.	125	0.0077	20.23	x	x	x		
10.0	010.	125	35 amperes @125 VAC/ 50 amperes @125 VDC 300 amperes @32 VDC PSE: 100 amperes @100VAC	0.0056	26.46	x	x	x	
12.0	012.	65	50 amperes @65 VAC/VDC	0.0049	47.97	x	x		
15.0	015.	65	300 amperes @24 VDC	0.0037	97.82	x	x		

Notes:
 - I²t calculated at 8ms.
 - Resistance is measured at 10% of rated current, 25°C

Temperature Derating Curve

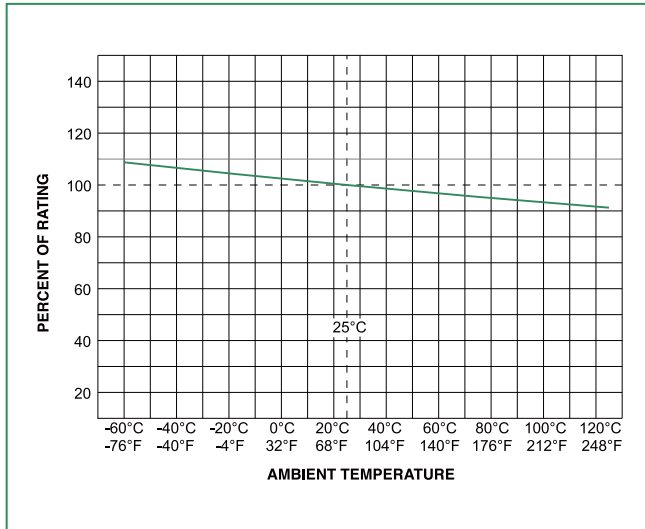

Note:

- Derating depicted in this curve is in addition to the standard derating of 25% for continuous operation.

Average Time Current Curves

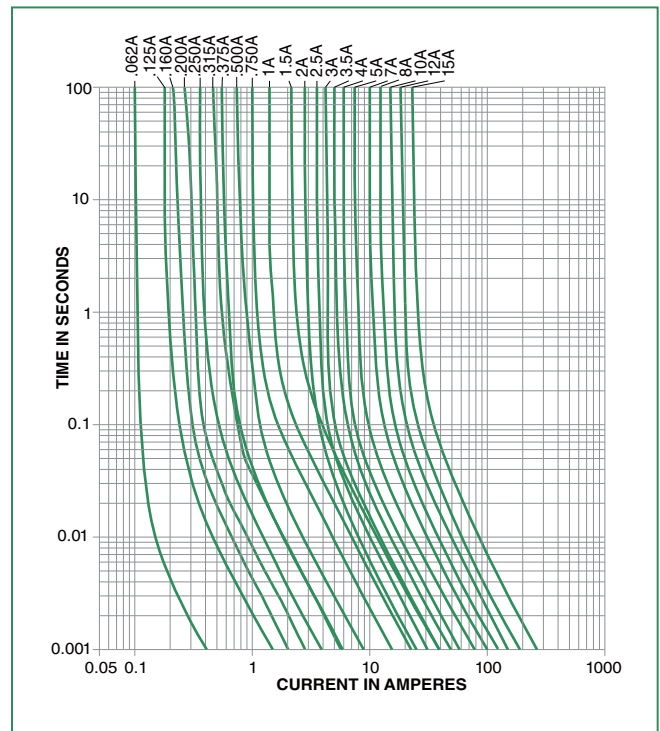

451/453 Series

Soldering Parameters

Reflow Condition		Pb – Free assembly
Pre Heat	- Temperature Min ($T_{s(min)}$)	150°C
	- Temperature Max ($T_{s(max)}$)	200°C
	- Time (Min to Max) (t_s)	60 – 120 secs
Average ramp up rate (Liquidus Temp (T_L) to peak)		5°C/second max.
$T_{s(max)}$ to T_L - Ramp-up Rate		5°C/second max.
Reflow	- Temperature (T_L) (Liquidus)	217°C
	- Temperature (t_L)	60 – 90 seconds
Peak Temperature (T_p)		250 ^{+0/-5} °C
Time within 5°C of actual peak Temperature (t_p)		20 – 40 seconds
Ramp-down Rate		5°C/second max.
Time 25°C to peak Temperature (T_p)		8 minutes max.
Do not exceed		260°C
Wave Soldering Parameters		260°C Peak Temperature, 10 seconds max.

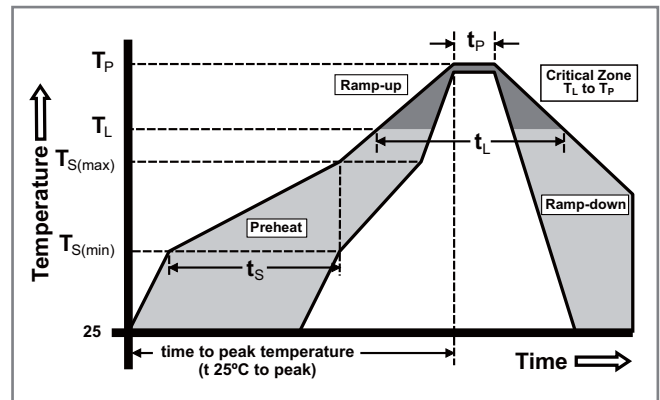

Product Characteristics

Materials	Body: Ceramic Terminations: Gold-Plated Caps (for 451 RoHS/HF series) SnPb Plated Caps (for 451 Non-RoHS series) Silver-plated Caps (for 451 RoHS below 200mA Rating & 453 Series)
Product Marking	Brand, Ampere Rating
Operating Temperature	-55°C to 125°C
Moisture Sensitivity Level	Level 1, J-STD-020C
Solderability	MIL-STD-202, Method 208
Insulation Resistance (after Opening)	MIL-STD-202, Method 302, Test Condition A (10,000 ohms minimum)

Thermal Shock	MIL-STD-202, Method 107, Test Condition B, 5 cycles, -65°C / +125°C, 15 minutes @ each extreme
Mechanical Shock	MIL-STD-202, Method 213, Test I: Deenergized. 100G's pk amplitude, sawtooth wave 6ms duration, 3 cycles XYZ+xyz = 18 shocks
Vibration	MIL-STD-202, Method 201: 0.03" amplitude, 10-55 Hz in 1 min. 2hrs each XYZ=6hrs
Moisture Resistance	MIL-STD-202, Method 106, 10 cycles
Salt Spray	MIL-STD-202, Method 101, Test Condition B (48hrs)
Resistance to Soldering Heat	MIL-STD-202, Method 210, Test condition B (10 sec at 260°C)

Dimensions

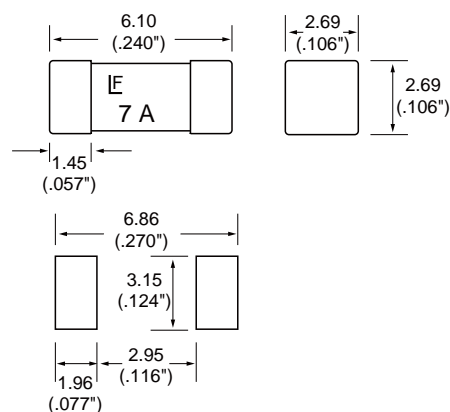

Recommended pad layout

Part Numbering System

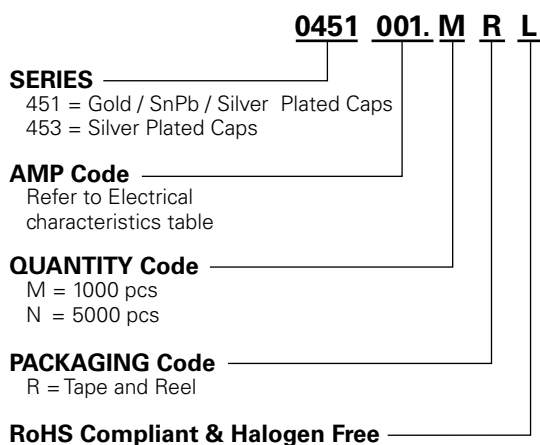





NOTE: "L" suffix applies to 451 series only

- 451 series may be ordered as either "RoHS and HF" ("L" suffix) or non-RoHS (no suffix) version.
 - 453 series is available only as RoHS compliant version and does not require "L" suffix. Please do not include "L" suffix within 453 series ordering instructions.
- 453 series is only available from 200mA up to the highest rating specified. For ratings below 200mA, please use 451 series for ordering.

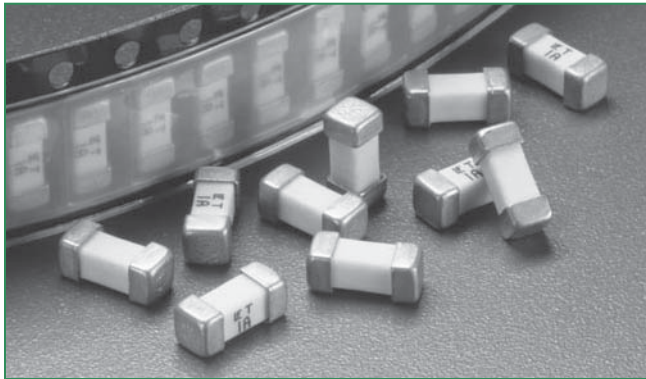
Packaging

Packaging Option	Packaging Specification	Quantity	Quantity & Packaging Code
12mm Tape and Reel	EIA RS-481-2 (IEC 286, part 3)	5000	NR
12mm Tape and Reel	EIA RS-481-2 (IEC 286, part 3)	1000	MR

RoHS HF 452/454 Series Fuse

Agency Approvals

AGENCY	AGENCY FILE NUMBER	AMPERE RANGE
	E10480	375mA - 7A
	LR29862	375mA - 7A
	NBK030205-E10480B	1A - 5A

Electrical Characteristics for Series

% of Ampere Rating	Opening Time
100%	4 hours, Minimum
200%	1 sec., Min.; 60 sec., Max.
300%	0.2 sec., Min.; 3 sec., Max
800%	0.02 sec., Min.; 0.1 sec., Max.

Description

The NANO² Slo-Blo® fuse has enhanced inrush withstand characteristics over the NANO² Fast-Acting fuse. The unique time delay feature of this fuse design helps solve the problem of nuisance “opening” by accommodating inrush currents that normally cause a fast-acting fuse to open.



Features

- Time-Lag (Slo-Blo)
- Small size
- Wide range of current rating available (375mA to 5A)
- Wide operating temperature range
- Low temperature de-rating
- RoHS compliant
- Halogen Free

Applications

- Notebook PC
- LCD/PDP TV
- LCD monitor
- LCD/PDP panel
- LCD backlight inverter
- Portable DVD player
- Power supply
- Networking
- PC server
- Cooling fan system
- Storage system
- Telecom system
- Wireless basestation
- White goods
- Game console
- Office Automation equipment
- Battery charging circuit protection
- Industrial equipment
- Medical equipment
- Automotive

Electrical Specifications by Item

Ampere Rating (A)	Amp Code	Max Voltage Rating (V)	Interrupting Rating	Nominal Cold Resistance (Ohms)	Nominal Melting I ² t (A ² sec)	Agency Approvals		
								
0.375	.375	125	50 amperes @ 125 VAC/VDC 300 amperes @ 32 VDC PSE: 100 amperes @ 100 VAC	1.2000	0.101	x	x	
0.500	.500	125		0.7000	0.240	x	x	
0.750	.750	125		0.3600	0.904	x	x	
001.	001.	125		0.2250	1.98	x	x	x
1.50	01.5	125		0.0930	3.65	x	x	x
2.00	002.	125		0.0625	8.20	x	x	x
2.50	02.5	125		0.0450	15.0	x	x	x
3.00	003.	125		0.0340	20.16	x	x	x
3.50	03.5	125		0.0224	26.53	x	x	x
4.00	004.	125		0.0186	34.40	x	x	x
5.00	005.	125		0.0136	53.72	x	x	x
7.00	007.	72		50 amperes @ 72 VAC 50 amperes @ 60 VDC	0.0105	123.83	x	x

Notes:
 - I²t calculated at 8ms.
 - Resistance is measured at 10% of rated current, 25°C

Temperature Derating Curve

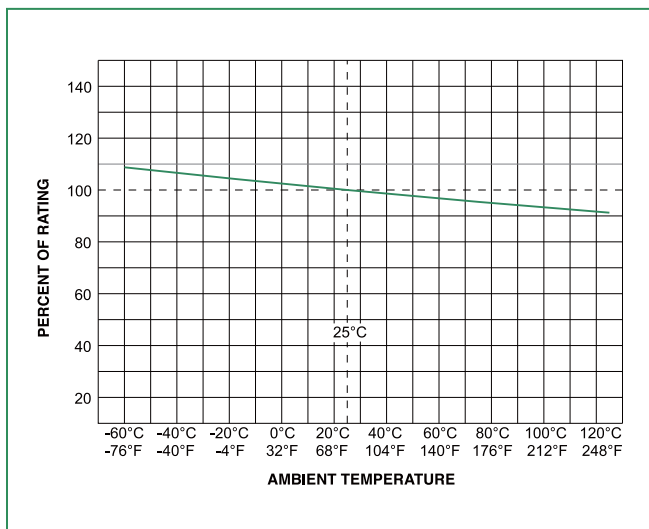

Note:
1. Derating depicted in this curve is in addition to the standard derating of 25% for continuous operation.

Average Time Current Curves

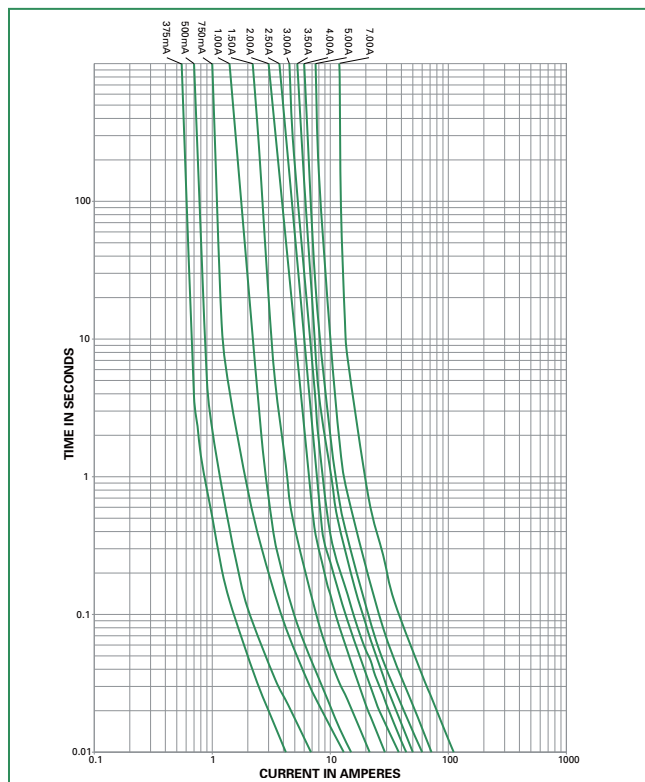

Soldering Parameters

Reflow Condition		Pb – Free assembly
Pre Heat	- Temperature Min ($T_{s(min)}$)	150°C
	- Temperature Max ($T_{s(max)}$)	200°C
	- Time (Min to Max) (t_s)	60 – 120 secs
Average ramp up rate (Liquidus Temp (T_L) to peak)		5°C/second max.
$T_{s(max)}$ to T_L - Ramp-up Rate		5°C/second max.
Reflow	- Temperature (T_L) (Liquidus)	217°C
	- Temperature (t_l)	60 – 90 seconds
Peak Temperature (T_p)		250 ^{+0/-5} °C
Time within 5°C of actual peak Temperature (t_p)		20 – 40 seconds
Ramp-down Rate		5°C/second max.
Time 25°C to peak Temperature (T_p)		8 minutes max.
Do not exceed		260°C
Wave Soldering Parameters		260°C Peak Temperature, 3 seconds max.

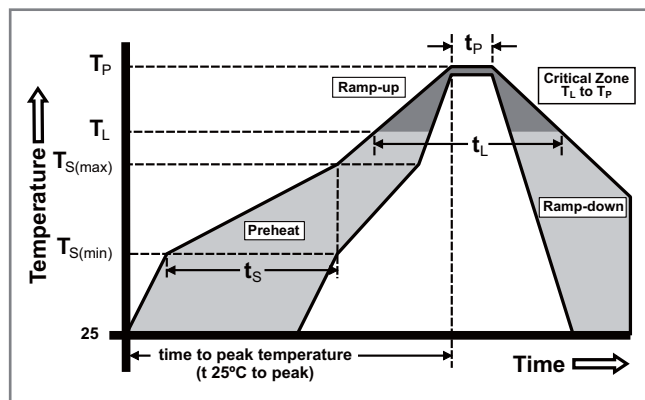

Product Characteristics

Materials	Body: Ceramic Terminations: Gold-plated Caps (452) / Silver-plated Caps (454)
Product Marking	Brand, Ampere Rating
Operating Temperature	-55°C to 125°C
Moisture Sensitivity Level	Level 1, J-STD-020C
Solderability	MIL-STD-202, Method 208
Insulation Resistance (after Opening)	MIL-STD-202, Method 302, Test Condition A (10,000 ohms minimum)

Thermal Shock	MIL-STD-202, Method 107, Test Condition B, 5 cycles, -65°C / +125°C, 15 minutes @ each extreme
Mechanical Shock	MIL-STD-202, Method 213, Test I: Deenergized. 100G's pk amplitude, sawtooth wave 6ms duration, 3 cycles XYZ+xyz = 18 shocks
Vibration	MIL-STD-202, Method 201: 0.03" amplitude, 10-55 Hz in 1 min. 2hrs each XYZ=6hrs
Moisture Resistance	MIL-STD-202, Method 106, 10 cycles
Salt Spray	MIL-STD-202, Method 101, Test Condition B (48hrs)
Resistance to Soldering Heat	MIL-STD-202, Method 210, Test condition B (10 sec at 260°C)

Dimensions

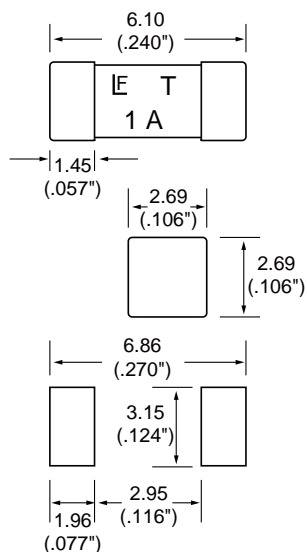

Recommended pad layout

Part Numbering System

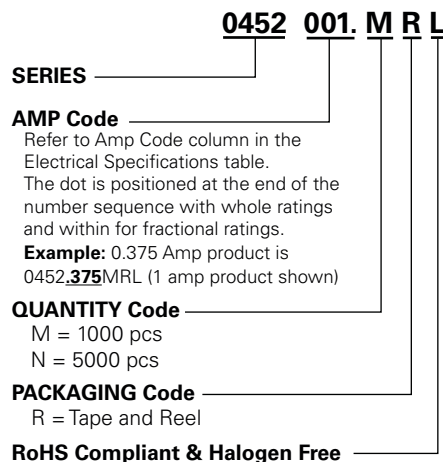

NOTE: "L" suffix applies to 452 series only

452 series may be ordered as either "RoHS and HF" ("L" suffix) or non-RoHS (no suffix) version.
 454 series is available only as "RoHS and HF" version and does not require "L" suffix.
 Please do not include "L" suffix within 454 series ordering instructions.

Packaging

Packaging Option	Packaging Specification	Quantity	Quantity & Packaging Code
12mm Tape and Reel	EIA RS-481-1 (IEC 286, part 3)	5000	NR
12mm Tape and Reel	EIA RS-481-1 (IEC 286, part 3)	1000	MR

RoHS HF 456 Series Fuse

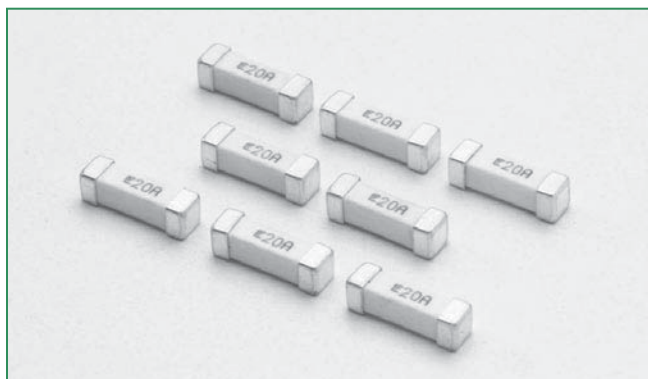

Description

The High Current NANO^{2®} Fuse is a small square surface mount fuse that is designed to support higher current requirements of various applications.

Features

- Surface mount high current fuse
- Fully compatible with lead-free solder alloys and higher temperature profiles associated with lead-free assembly
- RoHS compliant and Halogen Free
- Available in ratings of 20 to 40 Amperes

Applications

- Voltage regulator module for PC server
- Cooling fan system for PC server
- Storage system power
- Basestation power supply
- Automotive

Agency Approvals

AGENCY	AGENCY FILE NUMBER	AMPERE RATING
	E10480	20A, 30A, 40A
	NBK030308-JP1021	20A, 30A

Electrical Characteristics

% of Ampere Rating	Opening Time
100%	4 hours, Minimum
200%	60 seconds, Maximum

Electrical Specifications

Ampere Rating (A)	Amp Code	Max Voltage Rating (V)	Interrupting Rating	Nominal Cold Resistance (Ohms)	Nominal Melting I ² t (A ² Sec.)	Nom Voltage Drop (mV)	Agency Approvals	
20	020.	125	100A @125V AC 300A @ 65V AC 300A @ 100V DC 1000A @ 32V DC	0.00230	18	64.7	x	x
30	030.	125	100A @ 125V AC 300A @ 65V AC 1000A @ 32V DC	0.00132	81	69.9	x	x
40	040.	60	600A @ 60V DC	0.00105	454	55	x	

Notes:
 1. Cold resistance measured at less than 10% of rated current at 23°C.
 2. Agency Approval Table Key: X=Approved or Certified, P=Pending.
 3. I²t values stated for 10 msec opening time.

Temperature Derating Curve

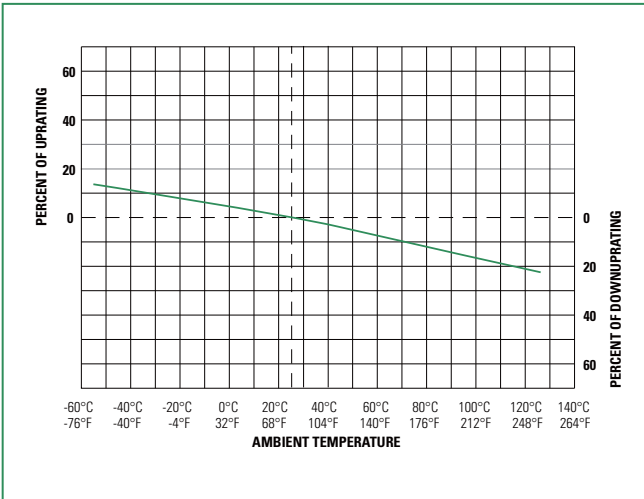

Average Time Current Curves

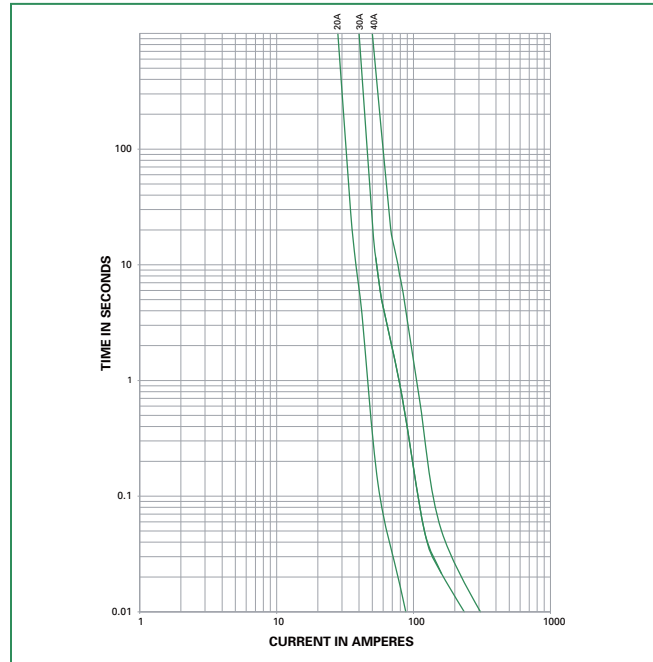

Soldering Parameters – Reflow Soldering

Reflow Condition		Pb – Free assembly
Pre Heat	- Temperature Min ($T_{s(min)}$)	150°C
	- Temperature Max ($T_{s(max)}$)	200°C
	- Time (Min to Max) (t_s)	60 – 180 secs
Average ramp up rate (Liquidus Temp (T_L) to peak)		5°C/second max.
$T_{s(max)}$ to T_L - Ramp-up Rate		5°C/second max.
Reflow	- Temperature (T_L) (Liquidus)	217°C
	- Temperature (t_L)	60 – 150 seconds
Peak Temperature (T_p)		250 ^{+0/-5} °C
Time within 5°C of actual peak Temperature (t_p)		20 – 40 seconds
Ramp-down Rate		5°C/second max.
Time 25°C to peak Temperature (T_p)		8 minutes max.
Do not exceed		260°C

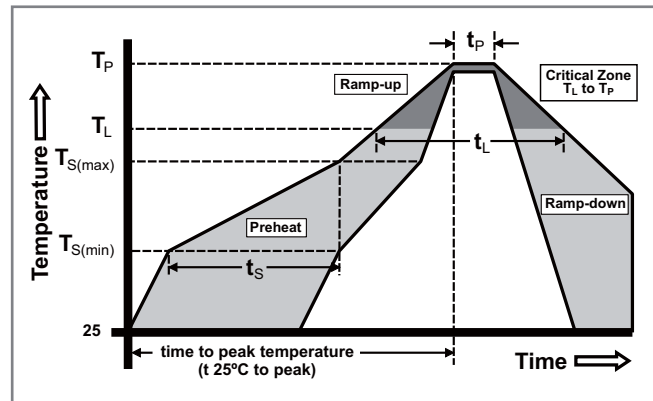

Product Characteristics

Materials	Body: Ceramic Cap: Silver Plated Brass
Product Marking	Body: Brand Logo, Current Rating
Insulation Resistance	MIL-STD-202, method 302, Test Condition A (10,000 ohms, Minimum)
Solderability	MIL-STD-202, Method 208
Resistance to Soldering Heat	MIL-STD-202, Method 210, Test Condition B (10 sec at 260°C)
PCB Recommendation for Thermal Management	Min. copper layer thickness = 100µm Min. copper trace width = 20A, 30 10mm (20A, 30A) / 15mm (40A) Alternate methods of thermal management may be used. In such cases, under normal operations, the maximum temperature of the fuse body should not exceed 80°C in a 25°C environment.

Operating Temperature	-55°C to 125°C with proper derating
Thermal Shock	MIL-STD-202F, Method 107G, Test Condition B (5 cycles -65°C to 125°C)
Vibration	MIL-STD-202F, Method 201A (10-55 Hz)
Moisture Sensitivity Level	Level 1 J-STD-020C
Moisture Resistance	MIL-STD-202F Method 106, High Humidity (90-98%RH), Heat (65°C)
Salt Spray	MIL-STD-202F, Method 101D, Test Condition B
Mechanical Shock	MIL-STD-202, Method 213, Test Condition I (100 G's peak for 6 milliseconds)

456 Series

Dimensions

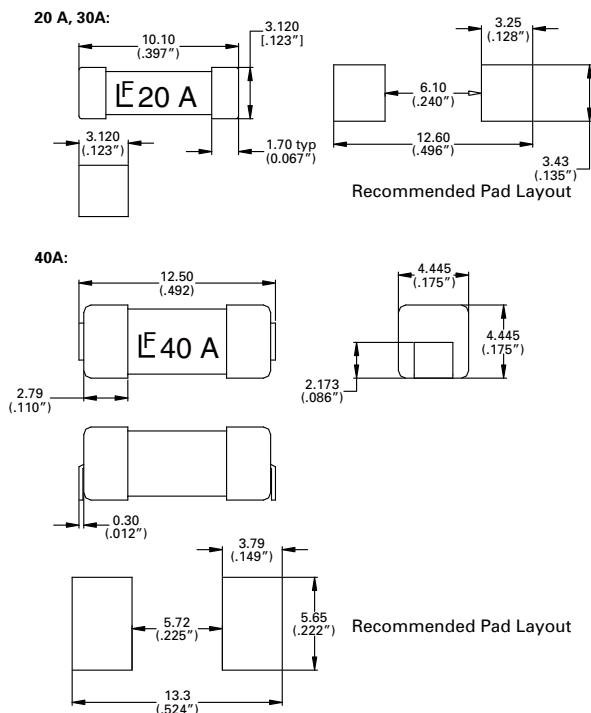

Part Numbering System

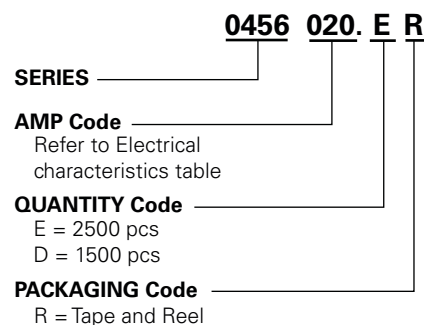

Packaging

Rating	Packaging Option	Packaging Specification	Quantity	Quantity & Packaging Code
20A, 30A	24 mm Tape and Reel	EIA RS-481-2	2500	ER
40A	24 mm Tape and Reel	EIA RS-481-2 (IEC 286, part 3)	1500	DR

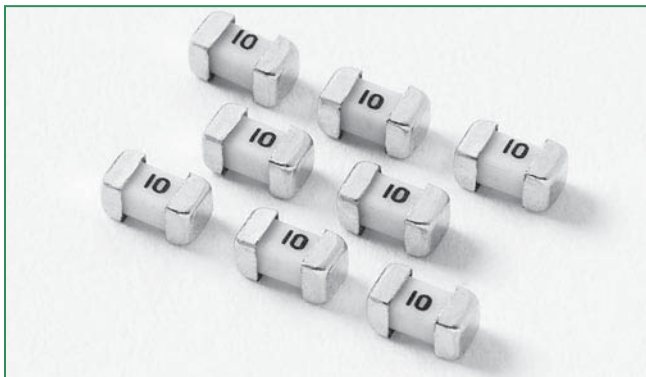
RoHS HF 458 Series Fuse

Description

The 458 Series Nano^{2®} Fuse is an ultra-small, square surface mount fuse designed to support a variety of space constrained overcurrent protection applications. Offering a 1206 size footprint, it is the smallest wire-in-air type surface mount fuse offered by Littelfuse.

Features

- Surface Mount Fuse
- Fully compatible with lead free soldering profiles
- RoHS Compliant
- Halogen Free
- Available in ratings of 1 to 10 Amperes

Applications

- Notebook PC
- LCD backlight inverter
- LCD Panel
- DC/DC converter
- Battery Pack
- Car Navigation System
- Network Equipment
- Telecom Equipment
- Electronic Signage
- Portable Consumer Electronics

Agency Approvals

AGENCY	AGENCY FILE NUMBER	AMPERE RANGE
	E10480	1A-10A

Electrical Characteristics for Series

% of Ampere Rating	Opening Time
100%	4 hours, Minimum
250%	5 seconds, Maximum

Electrical Specifications by Item

Ampere Rating (A)	Amp Code	Marking	Max Voltage Rating (V)	Interrupting Rating	Nominal Cold Resistance (Ohms)	Nominal Melting I ² t (A ² sec)	Agency Approvals
							
1.0	001.	1	63V	50A @63Vdc	0.180	.168	x
1.25	1.25	1.25			x		
1.5	01.5	1.5			x		
1.6	01.6	1.6			x		
2	002.	2			x		
2.5	02.5	2.5			x		
3	003.	3			x		
3.15	3.15	3.15			x		
3.5	03.5	3.5			x		
4	004.	4			x		
5	005.	5			x		
6.3	06.3	6.3			x		
7	007.	7			x		
8	008.	8	x				
10.0	010.	10	x				

Notes:

1. I²t values stated for 8 msec opening time
2. Cold resistance measured at less than 10% of rated current at 25°C.
3. Agency Approval Table Key: X=Approved or Certified, P=Pending and Blank=Not Approved
4. Have special electrical characteristic needs? Contact Littelfuse to learn more about application specific options.

Temperature Derating Curve

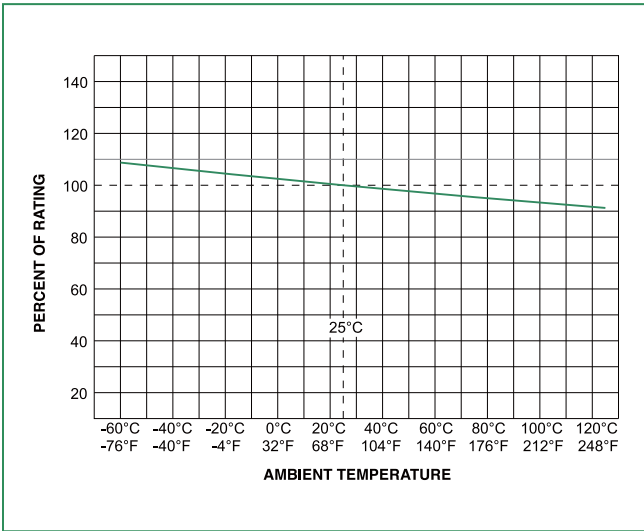

Note:

1. Derating depicted in this curve is in addition to the standard derating of 25% for continuous operation.

Average Time Current Curves

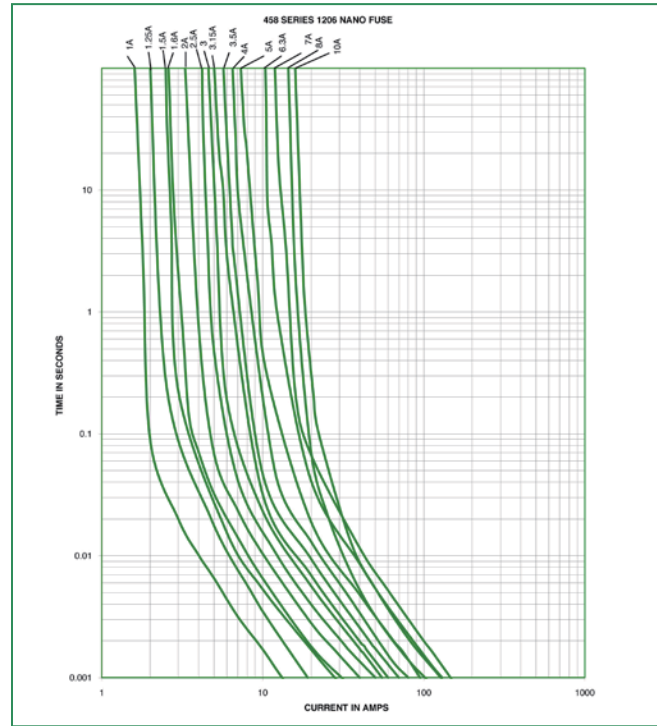

Soldering Parameters

Reflow Condition		Pb – Free assembly
Pre Heat	- Temperature Min ($T_{s(min)}$)	150°C
	- Temperature Max ($T_{s(max)}$)	200°C
	- Time (Min to Max) (t_s)	60 – 120 secs
Average ramp up rate (Liquidus Temp (T_L) to peak)		5°C/second max
$T_{s(max)}$ to T_L - Ramp-up Rate		5°C/second max
Reflow	- Temperature (T_L) (Liquidus)	217°C
	- Temperature (t_L)	60 – 90 seconds
Peak Temperature (T_p)		260 ^{+0/-5} °C
Time within 5°C of actual peak Temperature (t_p)		20 – 40 seconds
Ramp-down Rate		5°C/second max
Time 25°C to peak Temperature (T_p)		8 minutes Max.
Do not exceed		260°C

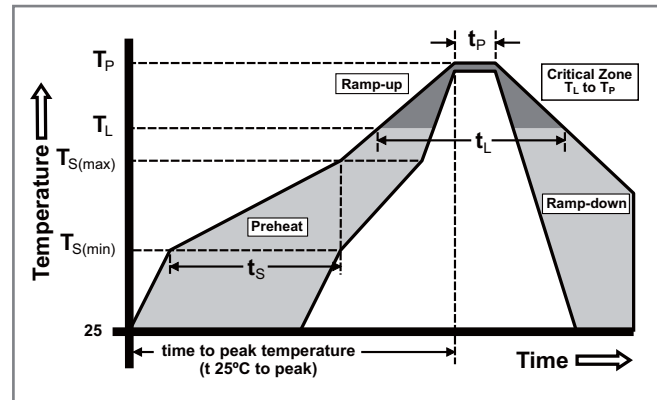

Product Characteristics

Materials	Body: Ceramic Cap: Gold Plated Brass
Product Marking	Body: Current Rating (Refer to Electrical Characteristic table)
Insulation Resistance (after Opening)	MIL-STD-202, Method 302, Test Condition A (10,000 ohms, Minimum)
Solderability	MIL-STD-202, Method 208
Resistance to Soldering Heat	MIL-STD-202, Method 210, Test Condition B (10 sec at 260°C)
Moisture Sensitivity Level	Level 1

Operating Temperature	-55°C to 125°C with proper derating
Thermal Shock	MIL-STD-202F, Method 107G, Test Condition B (5 cycles -65°C to +125°C)
Vibration	MIL-STD-202F, Method 201A (10-55 Hz)
Moisture Resistance	MIL-STD-202, Method 106, High Humidity (90-98%RH), Heat (65°C)
Salt Spray	MIL-STD-202F, Method 101D, Test Condition B
Shock	MIL-STD-202, Method 213, Test Condition I (100 G's peak for 6 milliseconds)

Dimensions

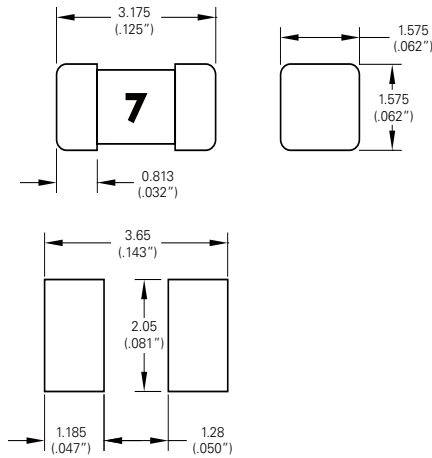

Recommended Pad Layout

Part Numbering System

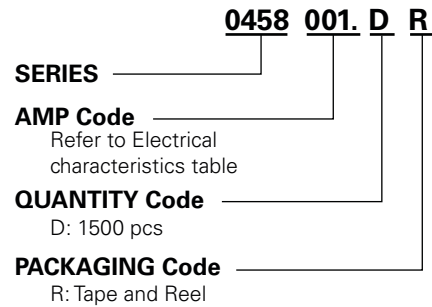

Example:
1.5 amp product is
0458 **01.5** D R (1 amp
product shown above).

Packaging

Packaging Option	Packaging Specification	Quantity	Quantity & Packaging Code
24mm Tape and Reel	EIA-RS 481-1	1500	DR

RoHS 443 Series Fuse

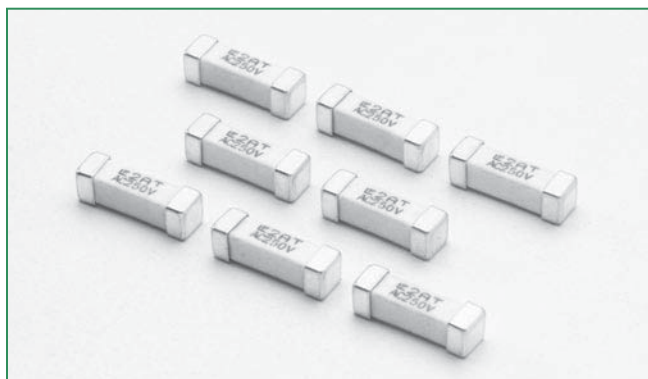

Description

The 250V Nano² Fuse is a small square surface mount fuse that is designed to enable compliance with the RoHS directive. This product is fully compatible with lead-free solder alloy and higher temperature profiles associated with lead-free assembly.

Features

- 250 VAC voltage rating
- Time-Lag
- Available 0.50A – 5.00A
- RoHS Compliant
- Fully compatible with lead-free solder alloys and higher temperature profiles associated with lead-free assembly

Agency Approvals

AGENCY	AGENCY FILE NUMBER	AMPERE RANGE
	E10480	0.500A - 5.00A

Electrical Characteristics for Series

% of Ampere Rating	Opening Time
100%	4 hours, Minimum
250%	120 seconds, Maximum

Applications

- AC/DC power adaptor
- Telecom equipment system power
- Portable system built-in AC/DC converter
- High voltage DC/DC converter
- Lighting System
- LED Lighting

Electrical Specifications by Item

Ampere Rating (A)	Amp Code	Max Voltage Rating (V)	Interrupting Rating	Nominal Cold Resistance (Ohms)	Nominal Melting I ² t (A ² sec)	Nominal Voltage Drop (mV)	Agency Approvals
							
0.50	.500	250	50A @250VAC	0.600	1.61	448	x
0.75	.750	250		0.275	1.00	285	x
1	001.	250		0.180	10.17	234	x
1.50	01.5	250		0.100	14.72	196	x
2	002.	250		0.052	18.06	154	x
2.50	02.5	250		0.035	18.13	139	x
3	003.	250		0.028	51.44	113	x
3.50	03.5	250		0.019	53.14	98	x
4	004.	250		0.016	70.56	81	x
5	005.	250		0.0115	127.79	80	x

Notes:

1. Cold resistance measured at less than 10% of rated current at 23°C.
2. Agency Approval Table Key: X=Approved or Certified, P=Pending and Blank=Not Approved
3. Have special electrical characteristic needs? Contact Littelfuse to learn more about application specific options.

Temperature Derating Curve

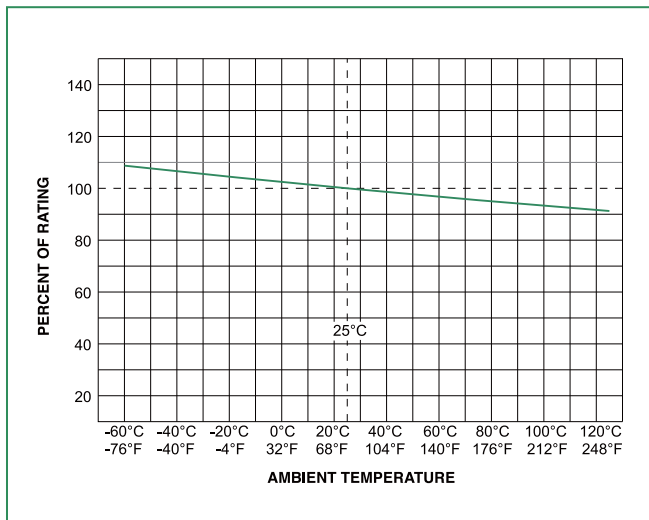

Note:

1. Derating depicted in this curve is in addition to the standard derating of 25% for continuous operation.

Average Time Current Curves

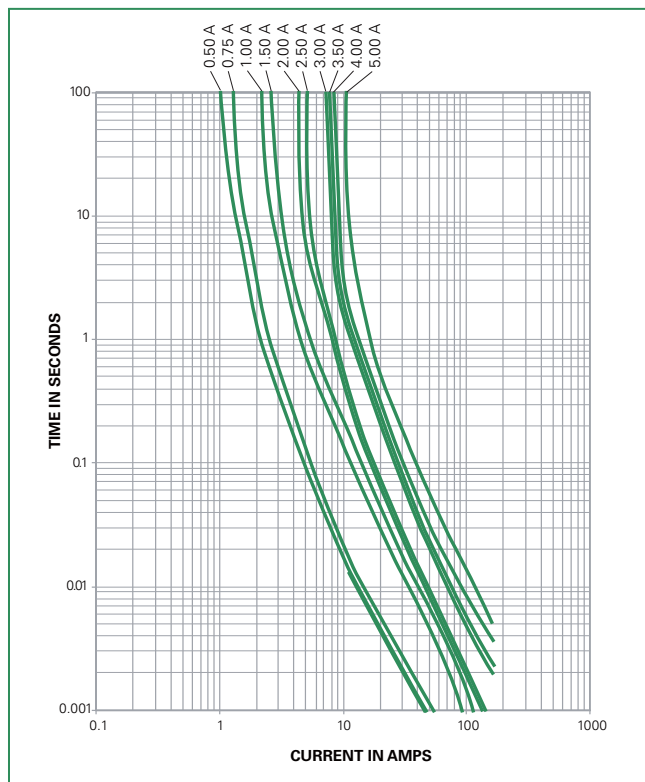

Soldering Parameters

Reflow Condition	Pb – Free assembly	
Pre Heat	- Temperature Min ($T_{s(min)}$)	150°C
	- Temperature Max ($T_{s(max)}$)	200°C
	- Time (Min to Max) (t_s)	60 – 120 secs
Average ramp up rate (Liquidus Temp (T_L) to peak)	5°C/second max.	
$T_{s(max)}$ to T_L - Ramp-up Rate	5°C/second max.	
Reflow	- Temperature (T_L) (Liquidus)	217°C
	- Temperature (t_l)	60 – 90 seconds
Peak Temperature (T_p)	250 ^{+0/-5} °C	
Time within 5°C of actual peak Temperature (t_p)	20 – 40 seconds	
Ramp-down Rate	5°C/second max.	
Time 25°C to peak Temperature (T_p)	8 minutes max.	
Do not exceed	260°C	
Wave Soldering Parameters	260°C Peak Temperature, 3 seconds max.	

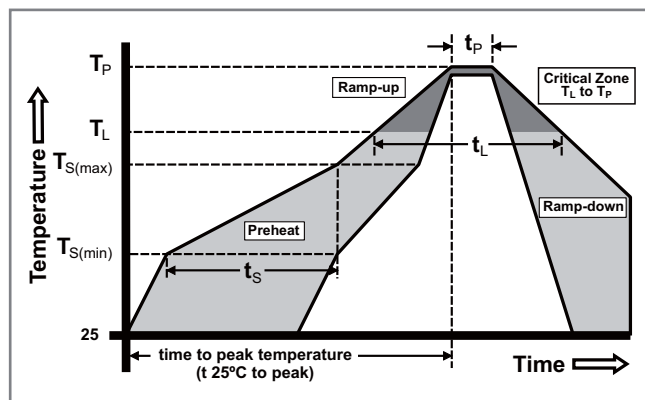

Product Characteristics

Materials	Body: Ceramic Cap: Silver Plated Brass
Product Marking	Body: Brand Logo, Current Rating Rated Voltage, T - C Characteristic "T"
Insulation Resistance (after Opening)	MIL-STD-202, Method 302, Test Condition A (10,000 ohms, Minimum)
Solderability	MIL-STD-202, Method 208
Resistance to Soldering Heat	MIL-STD-202, Method 210, Test Condition B (10 sec at 260°C)
Moisture Sensitivity Level	Level 1 J-STD-020C
PCB Recommendation for Thermal Management	Min. copper layer thickness = 100um Min. copper trace width = 10mm Alternate methods of thermal management may be used. In such cases, under normal operations, the maximum temperature of the fuse body should not exceed 80°C in a 25°C ambient environment.

Operating Temperature	-55°C to 125°C with proper derating
Thermal Shock	MIL-STD-202F, Method 107G, Test Condition B (5 cycles -65°C to +125°C)
Vibration	MIL-STD-202F, Method 201A (10-55 Hz)
Moisture Resistance	MIL-STD-202, Method 106, High Humidity (90-98%RH), Heat (65°C)
Salt Spray	MIL-STD-202F, Method 101, Test Condition B
Mechanical Shock	MIL-STD-202, Method 213, Test Condition I (100 G's peak for 6 milliseconds)

443 Series

Dimensions

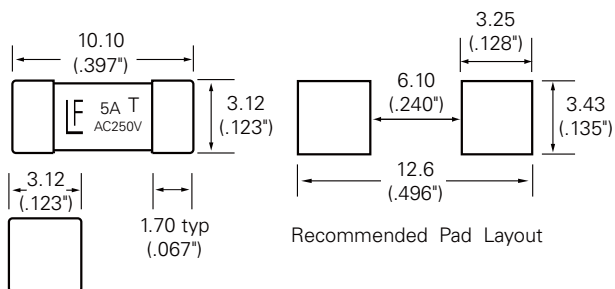

Part Numbering System

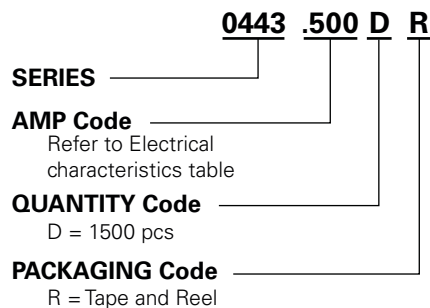

Example:
1.5 amp product is
0443 **01.5** D R (0.5 amp
product shown above).

Packaging

Packaging Option	Packaging Specification	Quantity	Quantity & Packaging Code
24mm Tape and Reel	EIA-RS 481-2 (IEC 286, part 3)	1500	DR

RoHS HF 464 Series Fuse



Description

The Surface Mount Nano² 250V UMF product family complies with IEC Publication IEC60127-4-Universal Modular Fuse-Links [UMF]. This IEC standard has been accepted by UL/CSA making it the first global fuse standard.

Features

- Fast Acting
- 250VAC Voltage rating
- Listed to IEC 60127-4, Universal Modular Fuse-Links (UMF), 250V
- RoHS compliant and Halogen Free

Agency Approvals

AGENCY	AGENCY FILE NUMBER	AMPERE RANGE
	NBK30502-E108480A	1A - 6.3A
	E184655A,B	500mA - 6.3A

Applications

- Power supply
- Industrial equipment
- Lighting system
- Medical equipment
- White goods

Electrical Characteristics for Series

% of Ampere Rating	Opening Time
125%	1 hour, Minimum
200%	2 minutes, Maximum
1000%	0.001 sec., Min.; 0.01 sec., Max.

Electrical Specifications by Item

Ampere Rating (A)	Amp Code	Max Voltage Rating (V)	Interrupting Rating	Nominal Cold Resistance (Ohms)	Nominal Melting I ² t (A ² sec)	Nominal Voltage Drop (mV)	Agency Approvals	
0.500	.500	250	100 amperes @250VAC	0.2373	0.22	600		x
0.800	.800	250		0.1159	0.96	400		x
1.00	001.	250		0.0762	0.51	300	x	x
1.25	1.25	250		0.0580	0.98	300	x	x
1.60	01.6	250		0.0448	1.67	300	x	x
2.00	002.	250		0.0354	2.48	300	x	x
2.50	02.5	250		0.0288	3.99	300	x	x
3.15	3.15	250		0.0206	8.05	300	x	x
4.00	004.	250		0.0156	13.85	300	x	x
5.00	005.	250		0.0119	23.6	300	x	x
6.30	06.3	250		0.0093	53.33	300	x	x

Notes:
 - I²t calculated at 8ms.
 - Resistance is measured at 10% of rated current, 25°C
 - For information and availability of additional ratings please contact Littelfuse

Temperature Derating Curve

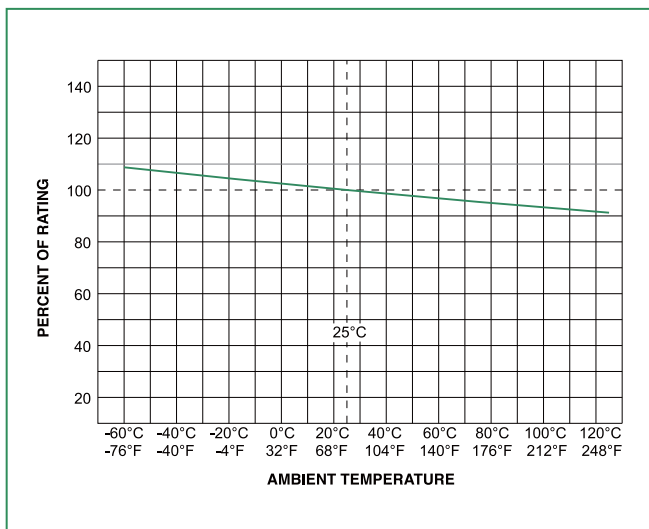

Note:
 1. Derating depicted in this curve is in addition to the standard derating of 15% for continuous operation.

Average Time Current Curves

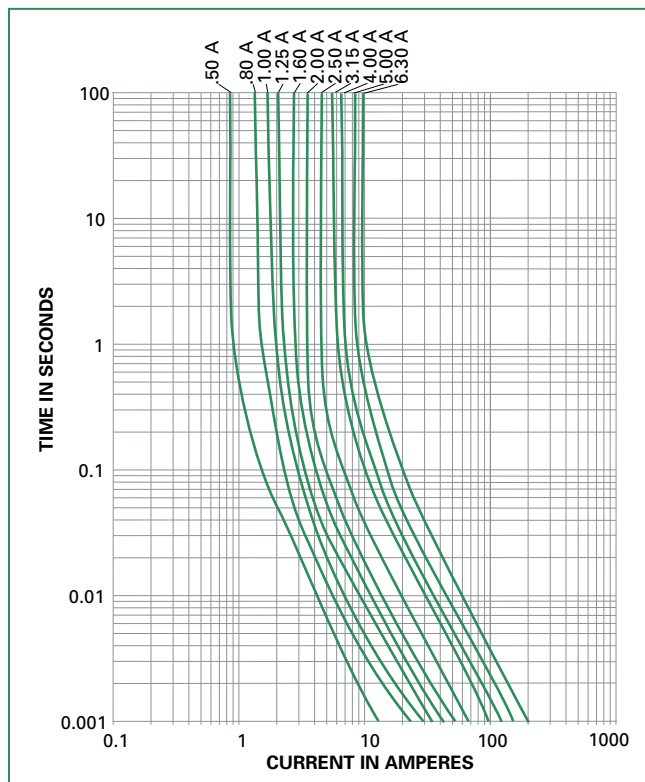

Soldering Parameters

Reflow Condition	Pb – Free assembly	
Pre Heat	- Temperature Min ($T_{s(min)}$)	150°C
	- Temperature Max ($T_{s(max)}$)	200°C
	- Time (Min to Max) (t_s)	60 – 120 secs
Average ramp up rate (Liquidus Temp (T_L) to peak)	5°C/second max.	
$T_{s(max)}$ to T_L - Ramp-up Rate	5°C/second max.	
Reflow	- Temperature (T_L) (Liquidus)	217°C
	- Temperature (t_l)	60 – 90 seconds
Peak Temperature (T_p)	250 ^{+0/-5} °C	
Time within 5°C of actual peak Temperature (t_p)	20 – 40 seconds	
Ramp-down Rate	5°C/second max.	
Time 25°C to peak Temperature (T_p)	8 minutes max.	
Do not exceed	260°C	
Wave Soldering Parameters	260°C Peak Temperature, 10 seconds max.	

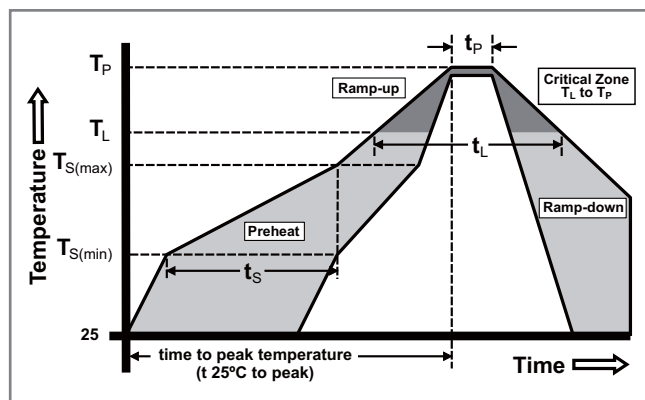

Product Characteristics

Materials	Body: Ceramic Terminations: Silver-plated Caps
Product Marking	Brand, Ampere Rating, Voltage Rating, UMF Logo
Operating Temperature	-55°C to 125°C
Moisture Sensitivity Level	Level 1, J-STD-020C
Solderability	IEC 60127-4
Insulation Resistance (after Opening)	IEC 60127-4 (0.1Mohm min @ 500VDC)

Thermal Shock	MIL-STD-202, Method 107, Test Condition B, 5 cycles, -65°C / +125°C
Mechanical Shock	MIL-STD-202, Method 213, Test Condition A
Vibration	MIL-STD-202, Method 201 (10-55 Hz)
Moisture Resistance	MIL-STD-202, Method 106, 10 cycles
Salt Spray	MIL-STD-202, Method 101, Test Condition B (48hrs)
Resistance to Soldering Heat	IEC 60127-4

Dimensions

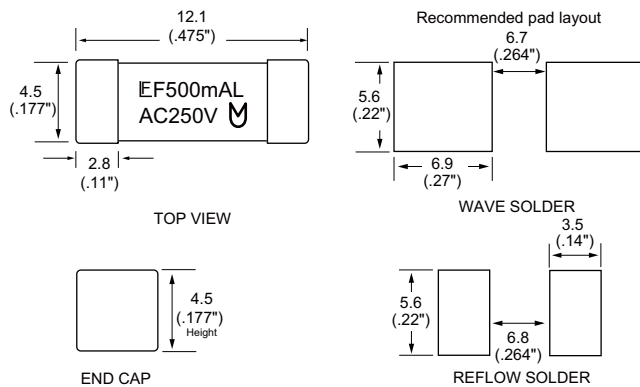

Part Numbering System

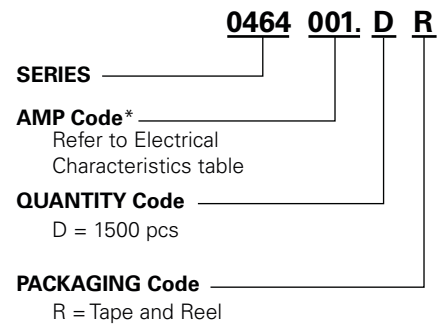

***Example:**
2.5 amp product is 0464**02.5**DR
(1 amp product shown above).

Packaging

Packaging Option	Packaging Specification	Quantity	Quantity & Packaging Code
24mm Tape and Reel	EIA RS-481-1 (IEC 286, part 3)	1500	DR

RoHS HF 465 Series Fuse

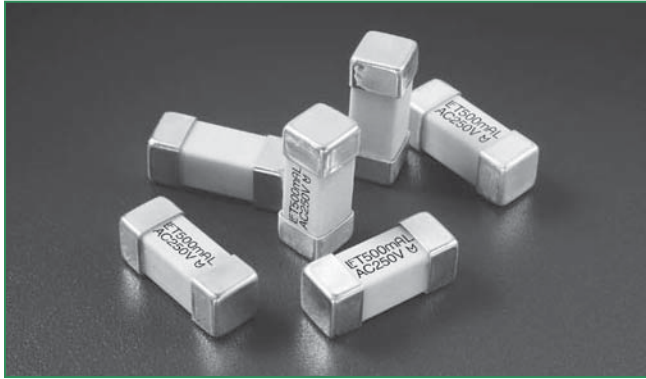

Description

The Surface Mount Nano² 250V UMF product family complies with IEC Publication IEC60127-4-Universal Modular Fuse-Links [UMF]. This IEC standard has been accepted by UL/CSA making it the first global fuse standard.

Features

- Time-Lag
- 250VAC Voltage rating
- Listed to IEC 60127-4, Universal Modular Fuse-Links (UMF), 250V
- RoHS compliant and Halogen Free

Agency Approvals

AGENCY	AGENCY FILE NUMBER	AMPERE RANGE
	NBK030205-E108480B	1A - 6.3A
	E184655A,B	250mA - 6.3A

Electrical Characteristics for Series

% of Ampere Rating	Opening Time
125%	1 hour, Minimum
200%	2 minutes, Maximum
1000%	0.01 sec., Min.; 0.1 sec., Max.

Applications

- Power supply
- Industrial equipment
- Lighting system
- Medical equipment
- White goods

Electrical Specifications by Item

Ampere Rating (A)	Amp Code	Max Voltage Rating (V)	Interrupting Rating	Nominal Cold Resistance (Ohms)	Nominal Melting I ² t (A ² sec)	Agency Approvals	
1.00	001.	250	100 amperes @250VAC	0.1070	2.8	x	x
1.25	1.25	250		0.0830	5.6	x	x
1.60	01.6	250		0.0560	9.2	x	x
2.00	002.	250		0.0390	14.9	x	x
2.50	02.5	250		0.0260	21.0	x	x
3.15	3.15	250		0.0210	31.7	x	x
4.00	004.	250		0.0160	48.4	x	x
5.00	005.	250		0.0130	87.0	x	x
6.30	06.3	250		0.0088	144.4	x	x

Notes:
 - I²t calculated at 8ms.
 - Resistance is measured at 10% of rated current, 25°C
 - For information and availability of additional ratings please contact Littelfuse

465 Series

Temperature Derating Curve

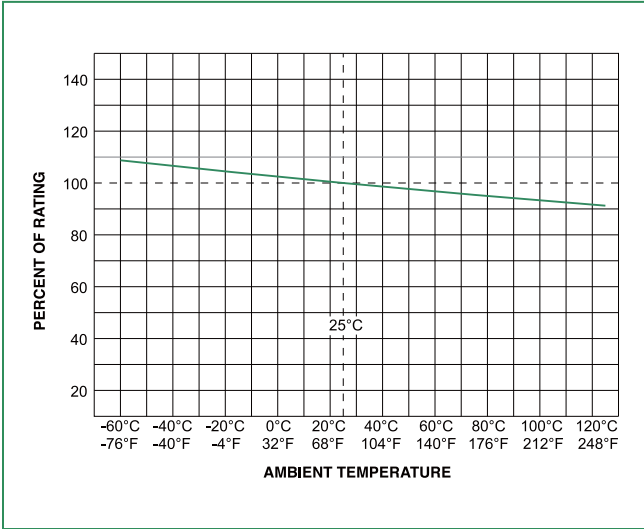

Note:

- Derating depicted in this curve is in addition to the standard derating of 15% for continuous operation.

Average Time Current Curves

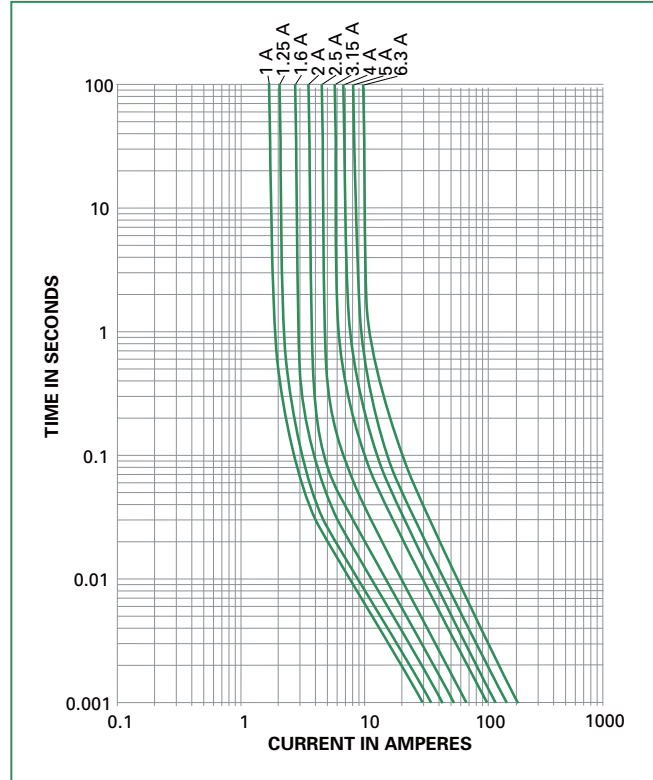

Soldering Parameters

Reflow Condition	Pb – Free assembly	
Pre Heat	- Temperature Min ($T_{s(min)}$)	150°C
	- Temperature Max ($T_{s(max)}$)	200°C
	- Time (Min to Max) (t_s)	60 – 120 secs
Average ramp up rate (Liquidus Temp (T_L) to peak)	5°C/second max.	
$T_{s(max)}$ to T_L - Ramp-up Rate	5°C/second max.	
Reflow	- Temperature (T_L) (Liquidus)	217°C
	- Temperature (t_l)	60 – 90 seconds
Peak Temperature (T_p)	250 ^{+0/-5} °C	
Time within 5°C of actual peak Temperature (t_p)	20 – 40 seconds	
Ramp-down Rate	5°C/second max.	
Time 25°C to peak Temperature (T_p)	8 minutes max.	
Do not exceed	260°C	
Wave Soldering Parameters	260°C Peak Temperature, 3 seconds max.	

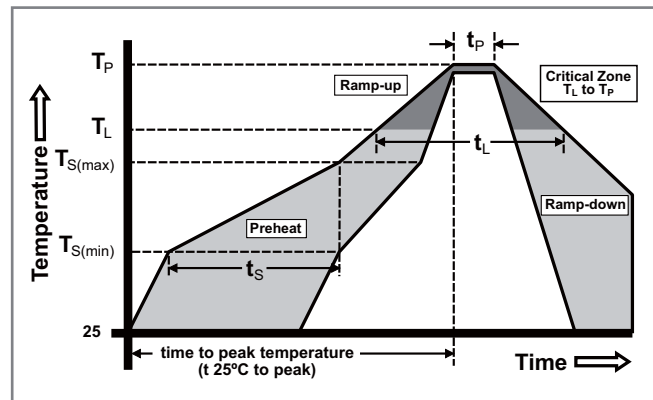

Product Characteristics

Materials	Body: High Performance Ceramic Terminations: Silver plated brass.
Product Marketing	Brand, Ampere Rating, Voltage Rating, UMF Logo
Operating Temperature	-55°C to 125°C.
Moisture Sensitivity Level	Level 1, J-STD-020C
Solderability	IEC60127-4
Insulation Resistance (after opening)	IEC 60127-4 (0.1Mohm min @ 500VDC)
Shock	MIL-STD-202, Method 213, Test Condition A

Thermal Shock	MIL-STD-202, Method 107, Test Condition B , 5 cycles, -65°C to 125°C
Mechanical Shock	MIL-STD-202, Method 213, Test Condition A
Vibration	MIL-STD-202, Method 201 (10-55 Hz)
Moisture Resistance	MIL-STD-202, Method 106, 10 cycles
Salt Spray	MIL-STD-202, Method 101, Test Condition B (48hrs)
Resistance to Soldering Heat	IEC 60127-4

Dimensions

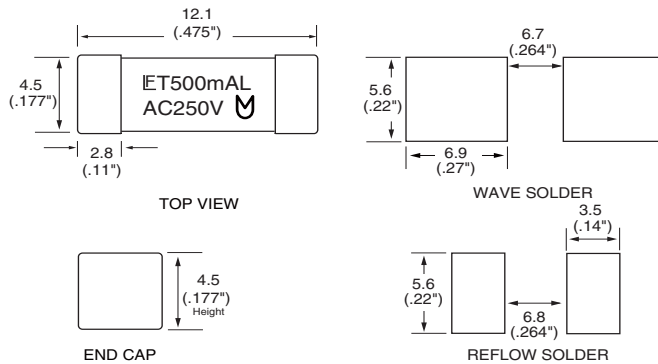

Part Numbering System

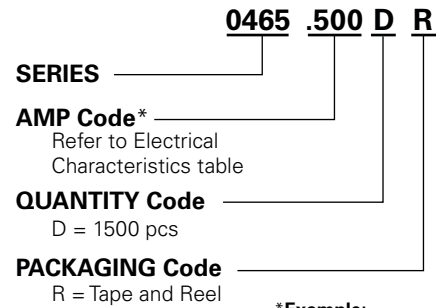

***Example:**
2.5 amp product is 046502.5DR
(0.5 amp product shown above).

Packaging

Packaging Option	Packaging Specification	Quantity	Quantity & Packaging Code
24mm Tape and Reel	EIA RS-481-1 (IEC 286, part 3)	1500	DR

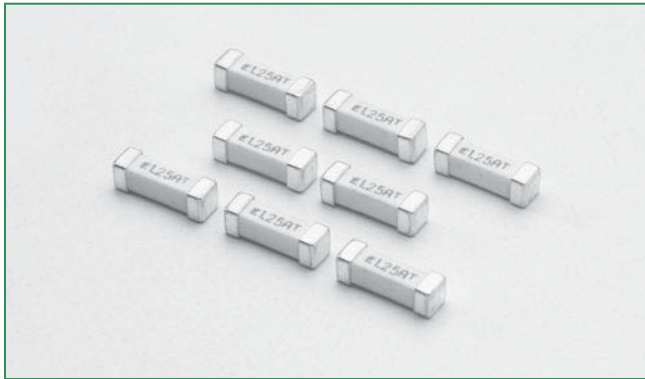

RoHS HF 461 Series TeleLink® Fuse



Description

The Littelfuse 461 Series TeleLink® Surface Mount, Surge Resistant Fuse, offers over-current protection for a wide range of telecom applications without requiring a series resistor. When used in conjunction with a Littelfuse SIDACtor® Transient Voltage Suppressor (TVS) or a Greentube™ Gas Plasma Arrestor, this combination provides a compliant solution for standards and recommendations such as GR-1089–Core, TIA-968-A, UL/EN/IEC 60950, and ITU K.20 and K.21. The coordination requirement contained in GR-1089–Core, and ITU K.20/21 may require a series of impedance devices.

Agency Approvals

AGENCY	AGENCY FILE NUMBER	AMPERE RANGE
	E10480	500mA - 2A
	LR29862	500mA - 2A

Electrical Characteristics for Series

% of Ampere Rating	Opening Time
100%	4 hours, Minimum
250%	1 sec., Min.; 120 secs., Max.

Maximum Temperature Rise

Telecom Nano ²⁰ Fuse	Temperature Reading
04611.25	< 82°C (180°F)
0461002.	< 50°C (122°F)

Higher Currents and PCB layout designs can affect this parameter.
 Readings are measured at rated current after temperature stabilizes.



Features

- Surface mount surge resistant Slo-Blo® fuse telecommunication and networking equipment
- Meet UL 60950 3rd Edition power cross requirements standard alone
- 2A rating has improved temperature rise performance under 2.2A surge current testing when compared with 1.25A rating
- Designed to allow compliance with Telcordia GR-1089-CORE and TIA-968-A (formerly FCC Part 68) Surge Specifications
- Product is Halogen Free and RoHS compliant and compatible with lead-free solder and higher temperature profiles when ordered with Standard Silver Plated Brass Caps
- Provide coordinated protection with Littelfuse SIDACtor® Transient Voltage Suppressor (TVS) or a Greentube™ Gas Plasma Arrestor, without series resistors
- Standard product is RoHS Compliant and compatible with lead-free solders and higher temperature profiles
- Designed to serve the requirements of a wide range of

Applications

- T1/E1/J1 and HDSL2/4
- SLIC interface portion of Fiber to the Curb (FTTC) and Fiber to the Premises (FTTP)
- Non-Fiber SLIC interface for Central Office (CO) locations and Remote Terminals (RT)
- xDSL applications such as ADSL, ADSL2+, VDSL, and VDSL2+
- Ethernet 10/100/1000BaseT
- POTS applications such as modems, answering machines, telephones, fax machines, and security systems
- ISDN "U" interface
- Baystation T1/E1/J1, T3 (DS3) trunk cards

Electrical Specifications by Item

Ampere Rating (A)	Amp Code	Max Voltage Rating (V)	Interrupting Rating	Nominal Cold Resistance (Ohms)	Nominal Melting I ² t (A ² sec)	Agency Approvals	
							
0.500	.500	600	60 A @600 VAC	0.560	0.840 ¹	x	x
1.25	1.25	600		0.110	16.5 ¹	x	x
2.00	002.	600		0.050	17.5 ¹	x	x

¹ I²t is calculated at 10 msec. or less. I²t at 10 times rated current has a typical value of: 24 A²sec (2.0A), 22 A²sec (1.25A), 1.3 A²sec (0.5A).

- Typical inductance <40nH up to 500 MHz.
- Resistance changes 0.5% for every °C.
- Resistance is measured at 10% rated current.

Temperature Derating Curve

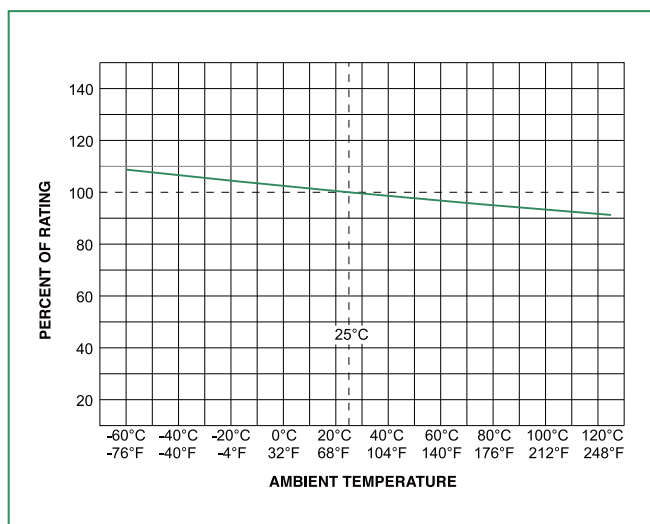

Note:
1. Derating depicted in this curve is in addition to the standard derating of 25% for continuous operation.

Average Time Current Curves

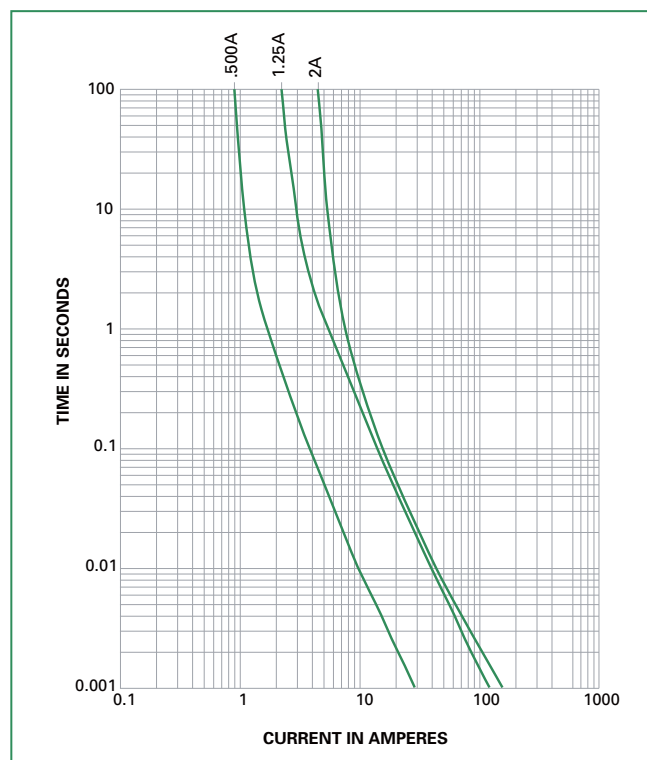

GR 1089 Inter-building requirements

GR 1089 1st level lighting surge inter-building
(Equipment under test can not be damaged and must continue to operate properly)

Surge	Minimum Peak Voltage (V)	Minimum Peak Current (A)	Max. Rise/Min. Decay (µs)	Repetitions Each Polarity	Fuse Choices
1	600	100	10/1000	25	1.25, 2.0
2	1000	100	10/360	25	1.25, 2.0
3	1000	100	10/1000	25	1.25, 2.0
4	2500	500	2/10	10	1.25, 2.0
5	1000	25	10/360	5	0.5, 1.25, 2.0

If sufficient series resistance is used, then the 0.5 fuse may be used in test conditions 1-4.

GR 1089 2nd level lightning surge telecom port
(Equipment under test shall not become a fire or electrical safety hazard)

Surge	Minimum Peak Voltage (V)	Minimum Peak Current (A)	Max. Rise/Min. Decay (µs)	Repetitions Each Polarity	Fuse Choices
1	5000	500	2/10	1	0.5, 1.25, 2.0
Alternative	5000	500/8=625	8/10	1	0.5, 1.25, 2.0

The 0.5 fuse will open during these test conditions. The 1.25 & 2.0 will not open thus providing operational compliance.

GR 1089 AC power fault 1st level inter-building (fuse not allowed to open)

Test	Vrms	Short Circuit Current (A)	Hits	Duration	Primary Protector	Fuse Choices
1	50	0.33	1	15 min.	removed	1.25, 2.0
2	100	0.17	1	15 min.	removed	1.25, 2.0
3	200,400, 600	1	60	1 sec.	removed	1.25, 2.0
4	1000	1	60	1 sec.	operative	1.25, 2.0
5	Diagram	Diagram	60	5 secs.	removed	1.25, 2.0
6	600	0.5	1	30 secs.	removed	1.25, 2.0
7	440	2.2	5	2 secs.	removed	1.25, 2.0
8	600	3	1	1.1 secs.	removed	1.25, 2.0
9	1000	5	1	0.4 sec.	in place	1.25, 2.0

GR 1089 AC power fault 2nd level (fuse can open but must open in a safe and controlled manner)

Test Circuit	Vrms	Short Circuit Current (A)	Duration	Fuse
1	120,277	25	15 min.	0.5, 1.25, 2.0
2	600	60	5 secs.	0.5, 1.25, 2.0
3	600	7	5 secs.	0.5, 1.25, 2.0
4	100-600	2.2	15 min..	0.5, 1.25, 2.0
5	Diagram	Diagram	15 min.	0.5, 1.25, 2.0

Fuse must open before wiring simulator fuse (MDL 2.0).

TIA -968-A (formerly FCC Part 68) Surge Waveforms (fuse can not open during type B events)

Surge	Voltage (V)	Waveform (µs)	Current (A)	Repetitions	Recommended Fuse
Metallic A	800	10 x 560	100	1 ea. polarity	1.25
Longitudinal A	1500	10 x 160	200	1 ea. polarity	1.25
Metallic B	1000	9 x 720	25	1 ea. polarity	1.25
Longitudinal B	1500	9 x 720	37.5	1 ea. polarity	1.25

For the type A events the 0.5 fuse will open, providing non-operational compliance. The 1.25 & 2.0 will not open, providing for operational compliance with TIA-968-A type A surge events.

UL 60950 requirements

UL60950 (EN 60950) (formerly UL 1950) Power Cross (L = longitudinal, M = metallic)

Test Number	Voltage (V)	Current (A)	Time	Fuse Choices
L1	600	40	1.5 secs.	0.5, 1.25, 2.0
L2	600	7	5 secs.	0.5, 1.25, 2.0
L3	600	2.2	30 min.	0.5, 1.25, 2.0
L4	200	2.2	30 min.	0.5, 1.25, 2.0
L5	120	25	30 min.	0.5, 1.25, 2.0
M1	600	40	1.5 secs.	0.5, 1.25, 2.0
M2	600	7	5 secs.	0.5, 1.25, 2.0
M3	600	2.2	30 min.	0.5, 1.25, 2.0
M4	600	2.2	30 min.	0.5, 1.25, 2.0

Selection of test number depends on current limiting F fire enclosure/spacing of end product

- 26 AWG line cord removes L1/M1 test requirement
- L5 conducted only if product does not pass section 6.1.2
- L2,M2,L3,M3,L4,M4 conducted if not in a fire enclosure

Fuse must open before the wiring simulator fuse (MDL 2.0).

Dimensions

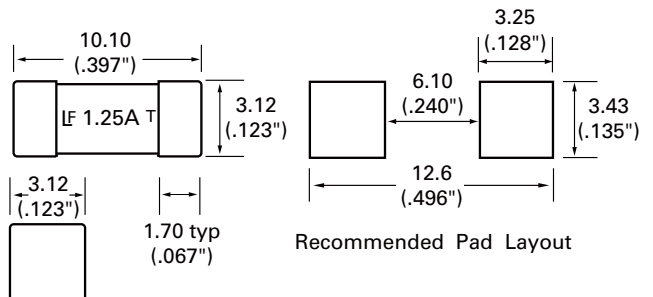

UL60950 (EN 60950) (formerly UL 1950) Impulse Test and Steady-State Electric Strength Test

Test	Voltage (V)	Current (A)	Waveform	Repetitions	Fuse Choices
Impulse					
For handheld units	2500	62.5	10 x 700ms	+/- 10 w/60 secs. rest	0.5, 1.25, 2.0
Non handheld	1500	37.5	10 x 700ms	+/- 10 w/60 secs. rest	0.5, 1.25, 2.0
Steady-State					
For handheld units	1500		60Hz		0.5, 1.25, 2.0
Non handheld	1000		60Hz		0.5, 1.25, 2.0

Soldering Parameters

Reflow Condition		Pb – free assembly
Pre Heat	- Temperature Min ($T_{s(min)}$)	150°C
	- Temperature Max ($T_{s(max)}$)	200°C
	- Time (Min to Max) (t_s)	60 – 120 seconds
Average Ramp-up Rate (Liquidus Temp (T_L) to peak)		5°C/second max.
$T_{s(max)}$ to T_L - Ramp-up Rate		5°C/second max.
Reflow	- Temperature (T_L) (Liquidus)	217°C
	- Temperature (t_L)	60 – 90 seconds
Peak Temperature (T_p)		250 ^{+0/-5} °C
Time within 5°C of actual peak Temperature (t_p)		20 – 40 seconds
Ramp-down Rate		6°C/second max.
Time 25°C to peak Temperature (T_p)		8 minutes max.
Do not exceed		260°C

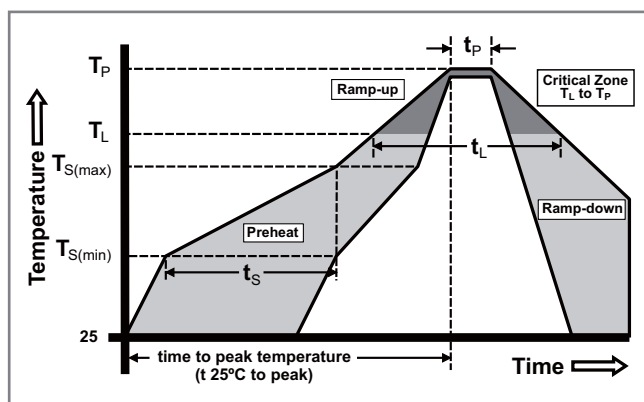

Product Characteristics

Materials	Body: Ceramic Terminations: Silver-plated Caps
Product Marking	Brand Logo, Ampere Rating
Operating Temperature	-55°C to 125°C
Moisture Sensitivity Level	Level 1, J-STD-020C
Solderability	IEC-60127-4 (215°C immersion, 3 seconds)
Resistance to Dissolution of Metallization	IPC / EIA J-STD-002A-Test D 260°C for 120 seconds

Thermal Shock	MIL-STD-202, Method 107, Test Condition B, -55°C to +125°C, 30 minutes @ each extreme
Mechanical Shock	MIL-STD-202, Method 213, Test Condition A - Half Sine, 50 G's, 11 msec. duration
High Frequency Vibration	MIL-STD-202, Method 204, Test Condition D
Moisture Resistance	MIL-STD-202, Method 106, 50 cycles
Terminal Strength	Board deflection per EIA / IS-722, 1mm deflection for 1 minute
Terminal Attachment	MIL-STD-202, Method 211, Test Condition A, 5 lbs applied to end caps

Part Numbering System

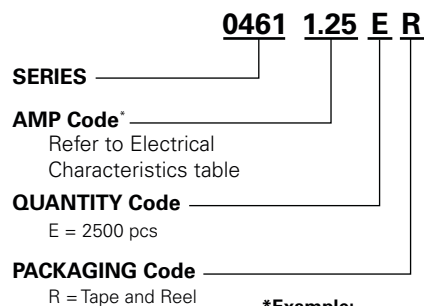

***Example:**
2 amp product is 0461**002**,ER
(1.25 amp product shown above)

Packaging

Packaging Option	Packaging Specification	Quantity	Quantity & Packaging Code
24mm Tape and Reel	EIA RS-481-2 (IEC 286, part 3)	2500	ER

RoHS

461E Series Enhanced TeleLink® Fuse

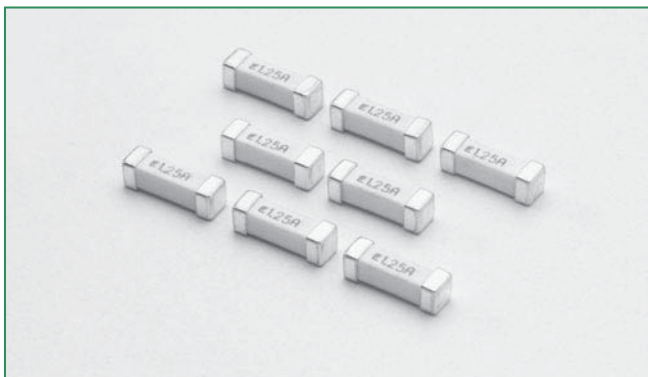

Description

The Littelfuse 461E Series Enhanced TeleLink® Surface Mount, Surge – Tolerant Fuse, is the next generation of the popular 461 TeleLink® Fuse. With optimized opening times at certain overload conditions, this enhanced TeleLink® Fuse works in harmony with Littelfuse’s new SIDACtor® Transient Voltage Suppressor products in the QFN package. This combination provides a compliant solution for standards and recommendations, such as, GR–1089–Core, TIA–968–A, UL/EN/IEC 60950 and ITU K.20/.21. The coordination requirement contained in GR–1089–Core and ITU K.20/.21, may require a series impedance device.

Agency Approvals

AGENCY	AGENCY FILE NUMBER	AMPERE RANGE
	E10480	1.25 A

Electrical Characteristics for Series

% of Ampere Rating	Opening Time
100%	4 Hours, Minimum
2.2A (176%)	300 Seconds, Maximum
200%	1 Second, Minimum; 60 Seconds, Maximum

Maximum Temperature Rise

Telecom Nano ² Fuse	Temperature Reading
04611.25E	< 82°C (180°F)

Higher Currents and PCB layout designs can affect this parameter.
 Readings are measured at rated current after temperature stabilizes.

Features

- Surface Mount Surge Resistant Slo-Blo® Fuse.
- Meets UL/EN/IEC 60950, 3rd Edition, Power Fault Requirements stand alone.
- Designed for compliance with Telcordia GR–1089–CORE and TIA–968–A (formerly FCC Part 68) Surge Specifications.
- Designed to serve the requirements of a wide range of telecommunication and networking equipment.
- Provides GR–1089 compliant overcurrent protection with Littelfuse SIDACtor®, TVS or GDT, without the need of any additional resistance.
- Product is RoHS compliant and compatible with lead-free solders and higher temperature profiles.

Applications

- T1/E1/J1 and HDSL2/4
- SLIC interface portion of Fiber to the Curb (FTTC) and Fiber to the Premises (FTTP)
- Non-Fiber SLIC interface for Central Office (CO) locations and Remote Terminals (RT)
- xDSL applications such as ADSL, ADSL2+, VDSL and VDSL2+
- Ethernet 10/100/1000BaseT
- POTS applications such as modems, answering machines, telephones, fax machines, and security systems
- ISDN “U” interface
- Baystation T1/E1/J1, T3 (DS3) trunk cards

461E Series

Electrical Specifications by Item

Ampere Rating (A)	Amp Code	Max Voltage Rating (V)	Interrupting Rating	Nominal Cold Resistance (Ohms)	Nominal Melting I ² t (A ² sec)	Agency Approvals
1.25	1.25	600	60 amperes @600 VAC	0.112	14.2	 x

I²t is calculated at 10 msec or less. I²t at 10 times rated current has a typical value of 17 A²sec (1.25A)

Resistance is measured at 10% rated current.

Temperature Derating Curve

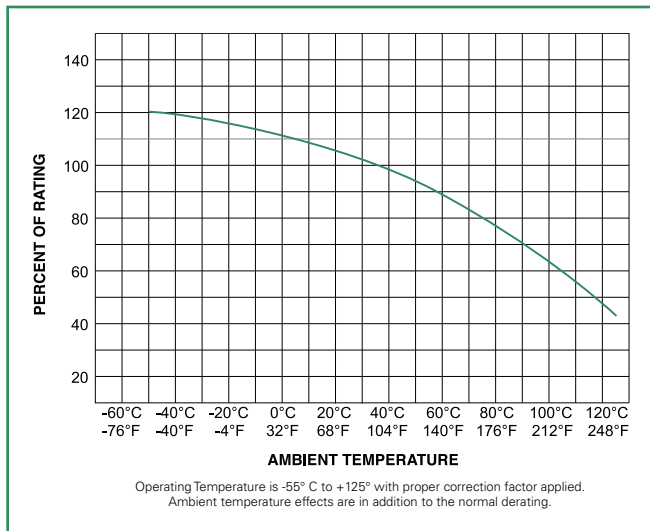

Note:

- Derating depicted in this curve is in addition to the standard derating of 25% for continuous operation.

Average Time Current Curves

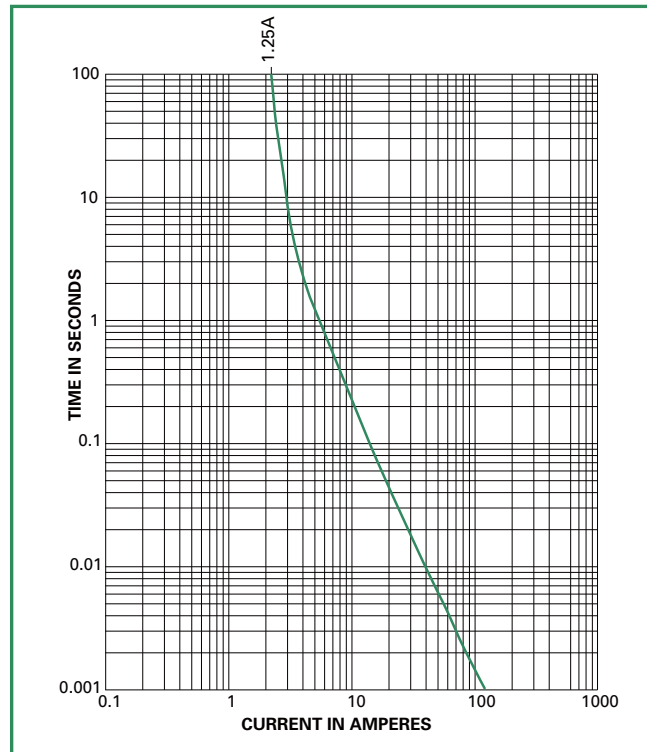

GR 1089 Inter-Building Requirements

GR 1089 1st level lighting surge inter-building (Equipment under test can not be damaged and must continue to operate properly)

Surge	Minimum Peak Voltage (V)	Minimum Peak Current (A)	Max. Rise/Min. Decay (µs)	Repetitions Each Polarity
1	600	100	10/1000	25
2	1000	100	10/360	25
3	1000	100	10/1000	25
4	2500	500	2/10	10
5	1000	25	10/360	5

GR 1089 2nd level lightning surge telecom port (Equipment under test shall not become a fire or electrical safety hazard)

Surge	Minimum Peak Voltage (V)	Minimum Peak Current (A)	Max. Rise/Min. Decay (µs)	Repetitions Each Polarity
1	5000	500	2/10	1
Alternative	5000	500/8=625	8/10	1

The 1.25 will not open thus providing operational compliance.

GR 1089 AC power fault 1st level inter-building (fuse not allowed to open)

Test	Vrms	Short Circuit Current (A)	Hits	Duration	Primary Protector
1	50	0.33	1	15 min.	removed
2	100	0.17	1	15 min.	removed
3	200,400,600	1	60	1 sec.	removed
4	1000	1	60	1 sec.	operative
5	Diagram	Diagram	60	5 sec.	removed
6	600	0.5	1	30 sec.	removed
7	440	2.2	5	2 sec.	removed
8	600	3	1	1.1 sec.	removed
9	1000	5	1	0.4 sec.	in place

GR 1089 AC power fault 2nd level (fuse can open but must open in a safe and controlled manner)

Test Circuit	Vrms	Short Circuit Current (A)	Duration
1	120,277	25	15 min.
2	600	60	5 sec.
3	600	7	5 sec.
4	100-600	2.2	15 min.
5	Diagram	Diagram	15 min.

Fuse must open before wiring simulator fuse (MDL 2.0).

TIA -968-A (formerly FCC Part 68) Surge Waveforms (fuse can not open during type B events)

Surge	Voltage (V)	Waveform (µs)	Current (A)	Reps
Metallic A	800	10 x 560	100	1 ea. polarity
Longitudinal A	1500	10 x 160	200	1 ea. polarity
Metallic B	1000	9 x 720	25	1 ea. polarity
Longitudinal B	1500	9 x 720	37.5	1 ea. polarity

For the type A events the fuse will not open, providing for operational compliance with TIA-968-A type A surge events.

UL 60950 requirements

UL60950 (EN 60950) (formerly UL 1950) Power Cross

(L = longitudinal, M = metallic)

Test Number	Voltage (V)	Current (A)	Time
L1	600	40	1.5 sec.
L2	600	7	5 sec.
L3	600	2.2	30 min.
L4	200	2.2	30 min.
L5	120	25	30 min.
M1	600	40	1.5 sec.
M2	600	7	5 sec.
M3	600	2.2	30 min.
M4	600	2.2	30 min.

Selection of test number depends on current limiting F fire enclosure/spacing of end product

- 26 AWG line cord removes L1/M1 test requirement
 - L5 conducted only if product does not pass section 6.1.2
 - L2,M2,L3,M3,L4,M4 conducted if not in a fire enclosure
- Fuse must open before the wiring simulator fuse (MDL 2.0).

Dimensions

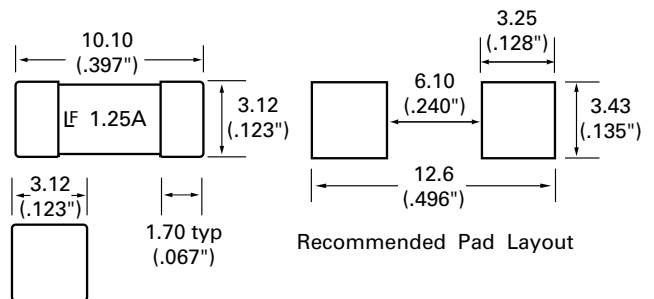

UL60950 (EN 60950) (formerly UL 1950) Impulse Test and Steady-State Electric Strength Test

Test	Voltage (V)	Current (A)	Waveform	Repetitions
Impulse				
For handheld units	2500	62.5	10 x 700ms	-/+ 10 w/60 Sec. rest
Non handheld	1500	37.5	10 x 700ms	-/+ 10 w/60 Sec. rest
Steady-State				
For handheld units	1500		60Hz	
Non handheld	1000		60Hz	

Soldering Parameters

Reflow Condition		Pb – Free assembly
Pre Heat	- Temperature Min ($T_{s(min)}$)	150°C
	- Temperature Max ($T_{s(max)}$)	200°C
	- Time (Min to Max) (t_s)	60 – 120 Seconds
Average ramp up rate (Liquidus Temp (T_L) to peak)		5°C/Sec. Max.
$T_{s(max)}$ to T_L - Ramp-up Rate		5°C/Sec. Max.
Reflow	- Temperature (T_L) (Liquidus)	217°C
	- Temperature (t_L)	60 – 90 Seconds
Peak Temperature (T_p)		250 ^{+0/-5} °C
Time within 5°C of actual peak Temperature (t_p)		20 – 40 Seconds
Ramp-down Rate		6°C/Sec. Max.
Time 25°C to peak Temperature (T_p)		8 Minutes Max.
Do not exceed		260°C

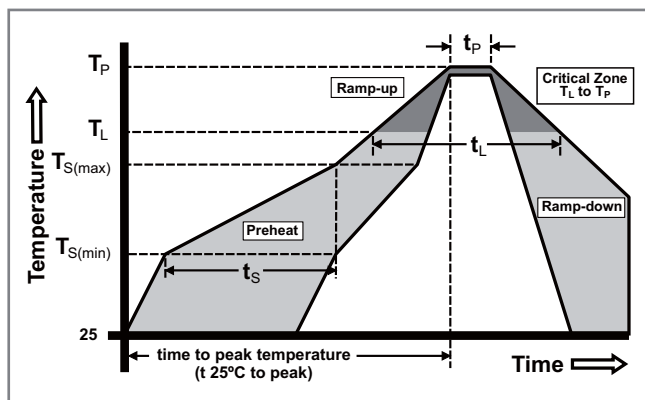

Product Characteristics

Materials	Body: Ceramic Terminations: Silver-plated Caps
Product Marking	Brand Logo, Ampere Rating
Operating Temperature	-55°C to +125°C
Moisture Sensitivity Level	Level 1, J-STD-020C
Solderability	IEC-60127-4 (215°C immersion, 3 Sec.)
Resistance to Dissolution of Metallization	IPC / EIA J-STD-002A-Test D 260°C for 120 Sec.

Thermal Shock	MIL-STD-202, Method 107, Test Condition B, 200 cycles, -55°C to +125°C, 30 minutes @ each extreme
Mechanical Shock	MIL-STD-202, Method 213, Test Condition A – Half Sine, 50 G's, 11 mSec duration
High Frequency Vibration	MIL-STD-202, Method 204, Test Condition D
Moisture Resistance	MIL-STD-202, Method 106, 50 cycles
Terminal Strength	Board deflection per EIA / IS-722, 1mm Deflection for 1 Minute
Terminal Attachment	MIL-STD-202, Method 211, Test Condition A, 5 lbs applied to end caps

Part Numbering System

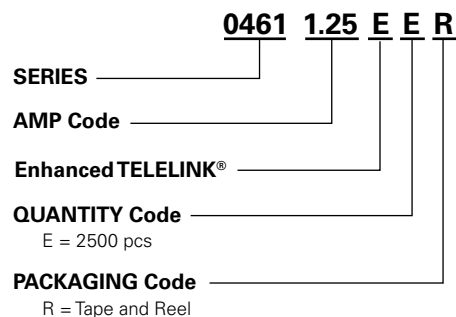

Packaging

Packaging Option	Packaging Specification	Quantity	Quantity & Packaging Code
24mm Tape and Reel	EIA RS-481-2 (IEC 286, part 3)	2500	ER

RoHS HF 154/154T/154L/154TL Series OMNI-BLOK® Fuse and Holder Assembly

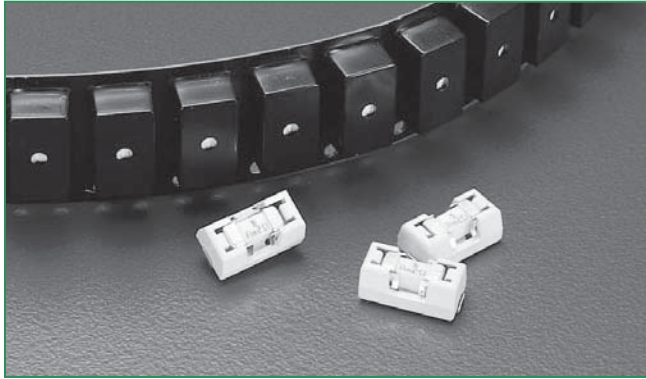

Agency Approvals

Approved by METI from 1 through 5 amperes.

AGENCY	AGENCY FILE NUMBER	AMPERE RANGE
	NBK030205-E10480A	154 Fast-Acting: 1A
	NBK030205-E10480B	154 Fast-Acting: 1A - 5A 154 Time-Lag: 1A - 5A
	NBK101105-E184655	154 Fast-Acting: 6.3A - 10A

Description

The RoHS compliant 154 Series OMNI-BLOK® offers a solution for efficient installation and easy replacement of miniature Nano²® surface mount fuses.

Offered in a tape and reel package, this fuse and holder combination can be installed on a PC board as an efficient single step. Fuse replacement can be accomplished without exposing the PC board to the detrimental effects of solder heat.

The fuse holder unit may be sold as a stand-alone item, shipped in bulk quantity (not pre-packaged in tape and reel cartridges) using part number 01550900. Please contact Littelfuse for additional information.

Features

- Easy fuse replacement
- Miniature size
- RoHS compliant and Halogen Free
- Very Fast-Acting and Time-Lag options available
- Holder sized to fit a range of Nano²® type fuses
- Low fuse temperature de-rating
- Wide range of current rating available
 - Fast-Acting: 62mA - 10A
 - Time-Lag: 375mA - 5A
- Wide operating temperature range
- Heat-resistant fuseholder, UL94 V-0
- Available in 260°C reflow capable fuseholder

Ordering Information

With Very Fast-Acting Fuse Installed

Catalog Number	Ampere Rating (A)	Amp Code	Fuse Furnished*
0154.062	0.062	.062	0451.062
0154.080	0.08	.080	0451.080
0154.100	0.1	.100	0451.100
0154.125	0.125	.125	0451.125
0154.160	0.16	.160	0453.160
0154.200	0.2	.200	0453.200
0154.250	0.25	.250	0453.250
0154.315	0.315	.315	0453.315
0154.375	0.375	.375	0453.375
0154.400	0.4	.400	0453.400
0154.500	0.5	.500	0453.500
0154.630	0.63	.630	0453.630
0154.750	0.75	.750	0453.750
0154.800	0.8	.800	0453.800
0154001.	1	001.	0453001.
01541.25	1.25	1.25	04531.25
015401.5	1.5	01.5	045301.5
015401.6	1.6	01.6	045301.6
0154002.	2	002.	0453002.
015402.5	2.5	02.5	045302.5
0154003.	3	003.	0453003.
01543.15	3.15	3.15	04533.15
015403.5	3.5	03.5	045303.5
0154004.	4	004.	0453004.
0154005.	5	005.	0453005.
015406.3	6.3	06.3	045306.3
0154007.	7	007.	0453007.
0154008.	8	008.	0453008.
0154010.	10	010.	0453010.

With Time-Lag (Slo-Blo®) Fuse Installed

Catalog Number	Ampere Rating (A)	Amp Code	Fuse Furnished*
0154.375 T	0.375	.375	0454.375
0154.500 T	0.5	.500	0454.500
0154.750 T	0.75	.750	0454.750
0154001. T	1	001.	0454001.
015401.5 T	1.5	01.5	045401.5
0154002. T	2	002.	0454002.
015402.5 T	2.5	02.5	045402.5
0154003. T	3	003.	0454003.
015403.5 T	3.5	03.5	045403.5
0154004. T	4	004.	0454004.
0154005. T	5	005.	0454005.
0154007. T	7	007.	0454007.

* The 453 and 454 Series fuses identified above have silver-plated end caps, designed to accommodate solder reflow processes:

For 453 Series fuse replacement, either 451, 453 or 448 Series may be used.

For 454 Series fuse replacement, either 452, 454 or 449 Series may be used.

For detailed operating characteristic and performance information for each of the fuse series mentioned above, please refer to their respective data available online at www.littelfuse.com.

Soldering Parameters

For 0154XXX.DR/DRT

Reflow Condition		Sn-Pb – Eutectic Assembly
Pre Heat	- Temperature Min ($T_{s(min)}$)	100°C
	- Temperature Max ($T_{s(max)}$)	150°C
	- Time (Min to Max) (t_s)	60 – 120 seconds
Average Ramp-up Rate (Liquidus Temp (T_L) to peak)		3°C/second max.
Reflow	- Temperature (T_L) (Liquidus)	183°C
	- Temperature (t_L)	60 – 90 seconds
Peak Temperature (T_p)		225 ^{+0/-5} °C
Time within 5°C of actual peak Temperature (t_p)		10 - 30 seconds
Ramp-down Rate		6°C/second max.
Time 25°C to peak Temperature (T_p)		6 minutes max.
Do not exceed		230°C

For 0154XXX.DRL/DRTL

Reflow Condition		Pb – Free assembly
Pre Heat	- Temperature Min ($T_{s(min)}$)	150°C
	- Temperature Max ($T_{s(max)}$)	200°C
	- Time (Min to Max) (t_s)	60 – 120 seconds
Average Ramp-up Rate (Liquidus Temp (T_L) to peak)		5°C/second max.
$T_{s(max)}$ to T_L - Ramp-up Rate		5°C/second max.
Reflow	- Temperature (T_L) (Liquidus)	217°C
	- Temperature (t_L)	60 – 90 seconds
Peak Temperature (T_p)		250 ^{+0/-5} °C
Time within 5°C of actual peak Temperature (t_p)		20 – 40 seconds
Ramp-down Rate		5°C/second max.
Time 25°C to peak Temperature (T_p)		8 minutes max.
Do not exceed		260°C

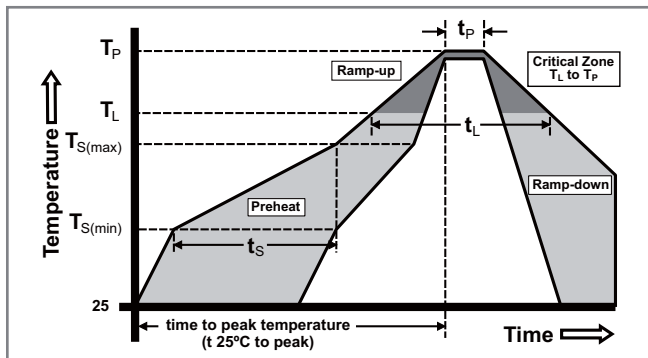

Dimensions

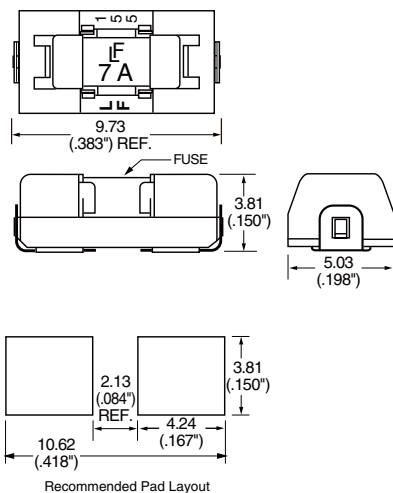

Product Characteristics

Operating Temperature	-55°C to 125°C
-----------------------	----------------

Part Numbering System

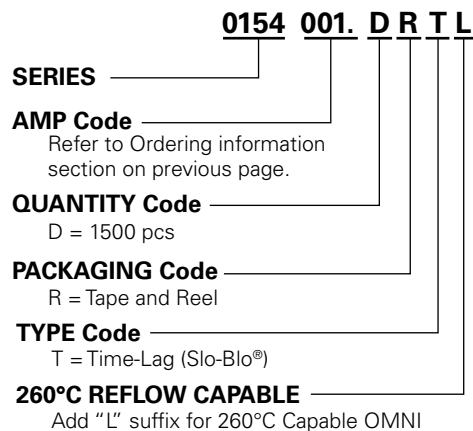

Example:
1.5 amp Fast-acting product is 0154**01.5**DR.
1.5 amp Time-lag product is 0154**01.5**DRT.
(1 amp product shown above).

Packaging

Packaging Option	Packaging Specification	Quantity	Quantity & Packaging Code
Reel Pack	EIA RS-481-2 (IEC 286, part 3)	1500	DR

RoHS HF 157 Series – Standard Nano Fuse and Clip Assembly



Description

The 157 Series – Standard Nano Fuse/Clip assembly is a small, square, very fast acting surface mount fuse that is assembled in surface mountable fuse clips. The fuse clip and pre-installed fuse combination can be automatically placed in PC Board in one efficient manufacturing operation. It permits quick and easy replacement of fuses without performing desoldering process, even in the field and without exposing the PC Board to detrimental effects of rework solder heat.

Features

- Surface Mountable, Very Fast Acting Fuse.
- Fully compatible with RoHS/Pb-Free solder alloys and higher temperature profiles associated with leadfree assembly.
- Easily replaceable on PC Board (Field Replaceable)
- RoHS compliant and Halogen Free
- Available in ratings of 0.062 ~ 10 Amperes.

Agency Approvals

AGENCY	AGENCY FILE NUMBER	AMPERE RANGE
	E14721	0.062A ~ 10A
	NBK030205-E10480A NBK030205-E10480B NBK101105-E184655	1A 1.5A - 5A 6.3A - 10A

Electrical Characteristics for Series

% of Ampere Rating	Opening Time at 25°C
100%	4 hours Minimum
200%	5 secs. Maximum

Applications

- Instrumentation
- Telecommunications
- Base Stations

Electrical Specifications by Item

Ampere Rating (A)	Amp Code	Max Voltage Rating (V)	Interrupting Rating (A)	Fuse Furnished	Nominal Cold Resistance (Ohms)	Nominal Melting I ² t (A ² sec)	Agency Approvals	
0.062	.062	125	50A @ 125 VAC/VDC 300A @ 32 VDC	0451.062	5.5372	0.00019	X	
0.080	.080	125		0451.080	4.0500	0.00033	X	
0.100	.100	125		0451.100	3.1000	0.00138	X	
0.125	.125	125		0451.125	1.7059	0.00286	X	
0.160	.160	125		0453.160	1.2157	0.0048	X	
0.200	.200	125		0453.200	1.3971	0.00652	X	
0.250	.250	125		0453.250	1.0496	0.01126	X	
0.315	.315	125		0453.315	0.3881	0.0311	X	
0.375	.375	125		0453.375	0.6083	0.0425	X	
0.400	.400	125		0453.400	0.5600	0.0484	X	
0.500	.500	125		0453.500	0.4181	0.0795	X	
0.630	.630	125		0453.630	0.3050	0.143	X	
0.750	.750	125		0453.750	0.2458	0.185	X	
0.800	.800	125		0453.800	0.2120	0.271	X	
1.0	001.	125		0453001.	0.1537	0.459	X	X
1.25	1.25	125		04531.25	0.078	0.664	X	X
1.5	01.5	125		045301.5	0.0634	0.853	X	X
1.6	01.6	125		045301.6	0.0580	1.060	X	X
2.0	002.	125		0453002.	0.0373	0.530	X	X
2.5	02.5	125		045302.5	0.0288	1.029	X	X
3.0	003.	125	0453003.	0.0229	1.650	X	X	
3.15	3.15	125	04533.15	0.0215	1.920	X	X	
3.5	03.5	125	045303.5	0.0203	2.469	X	X	
4.0	004.	125	0453004.	0.0163	3.152	X	X	
5.0	005.	125	0453005.	0.0127	5.566	X	X	
6.3	06.3	125	045306.3	0.0098	9.17	X	X	
7.0	007.	125	0453007.	0.0092	10.32	X	X	
8.0	008.	125	0453008.	0.0079	20.23	X	X	
10.0	010.	125	35A @ 125 VAC / 50A @125 VDC 300A @ 32VDC	0453010.	0.0058	26.46	X	X

1. Cold resistance measured at less than 10% of rated current at 23°C.
 2. I²t values stated for 8ms opening time.

3. Agency Approval Table Key: X=Approved or Certified, P=Pending and Blank=Not Approved
 4. Have special electrical characteristic needs? Contact Littelfuse to learn more about application specific options.

Temperature Derating Curve

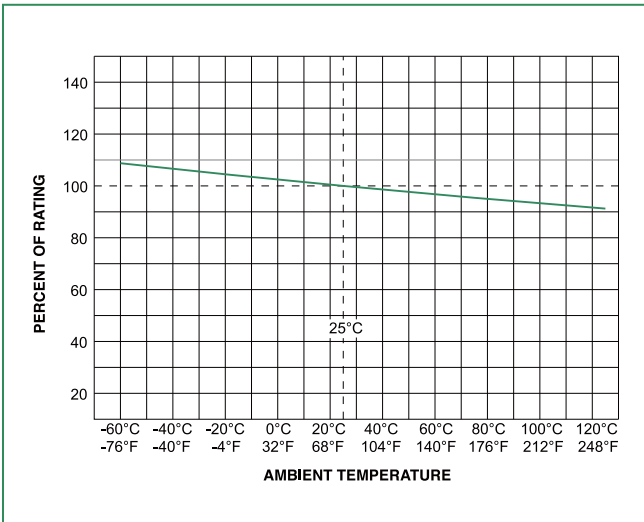

Note:

1. Derating depicted in this curve is in addition to the standard derating of 25% for continuous operation.

Average Time Current Curves

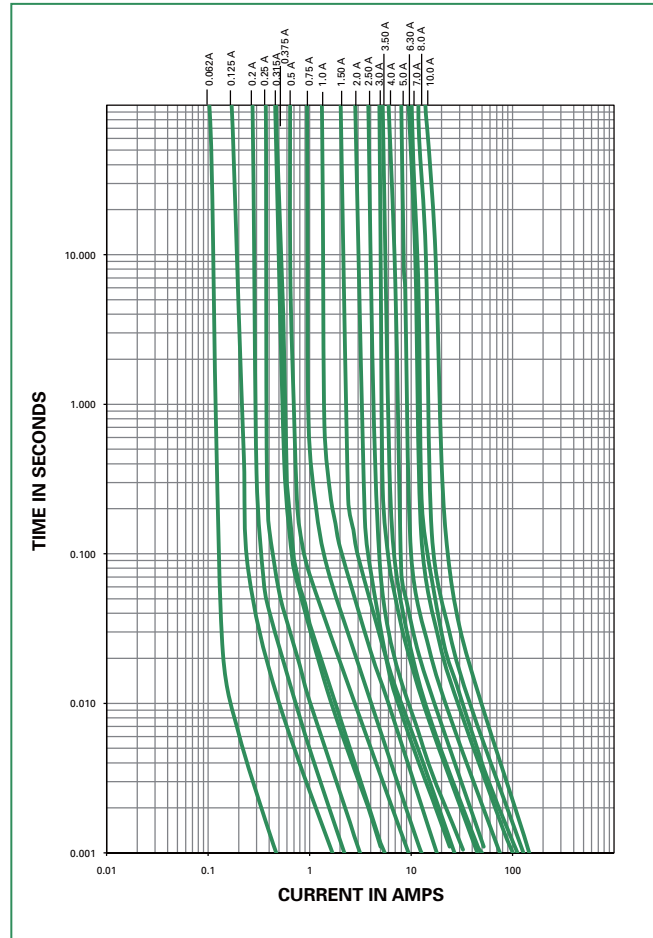

Soldering Parameters

Reflow Condition		Pb – Free assembly
Pre Heat	- Temperature Min ($T_{s(min)}$)	150°C
	- Temperature Max ($T_{s(max)}$)	200°C
	- Time (Min to Max) (t_s)	60 – 120 secs
Average ramp up rate (Liquidus Temp (T_L) to peak)		5°C/second max.
$T_{s(max)}$ to T_L - Ramp-up Rate		5°C/second max.
Reflow	- Temperature (T_L) (Liquidus)	217°C
	- Temperature (t_L)	60 – 90 seconds
Peak Temperature (T_p)		250 ^{+0/-5} °C
Time within 5°C of actual peak Temperature (t_p)		20 – 40 seconds
Ramp-down Rate		5°C/second max.
Time 25°C to peak Temperature (T_p)		8 minutes max.
Do not exceed		260°C

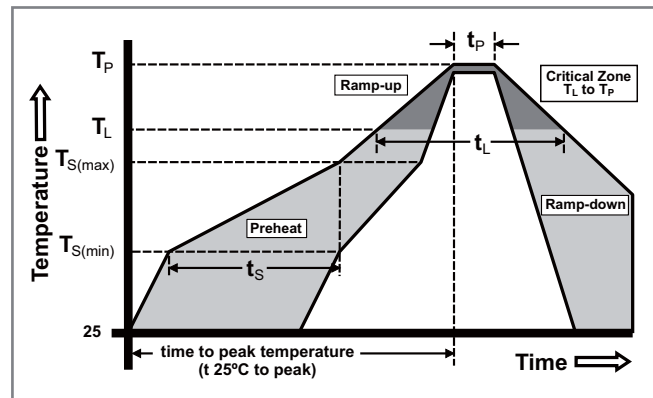

Product Characteristics

Materials	Body: Ceramic Cap: For 0.062A ~ 0.125A – Au plated Brass For 0.200A ~ 10A – Silver plated Brass Clip Plating: Matte Tin
Product Marking	Body: Brand Logo, Current Rating
Clip Retention	Force applied at fuse center, perpendicular to the long axis (@ 0.75 lbs. MIN)
Solderability	MIL-STD-202, Method 208 / IPC/ EIA / JEDEC J-STD002B, Test Condition A
Humidity Test	MIL –STD-202, Method 103 @ 85°C / 85%RH, 1000 hours
Resistance to Solvents	MIL-STD-202, Method 215 (3 solvent types)

Operating Temperature	-55°C to 125°C with proper derating
Thermal Shock	MIL-STD-202, Method 107, Test Condition B (5 cycles -65°C to +125°C)
Vibration	MIL-STD-202, Method 201 (10-55 Hz)
Moisture Resistance	MIL-STD-202, Method 106, 10 cycles
Salt Spray/ Atmosphere	MIL-STD-202, Method 101, Test Condition B (48 hrs.), 5% NaCl in De-ionized Water
Shock	MIL-STD-202, Method 213, Test Condition I (100 G's peak for 6 milliseconds)

Dimensions

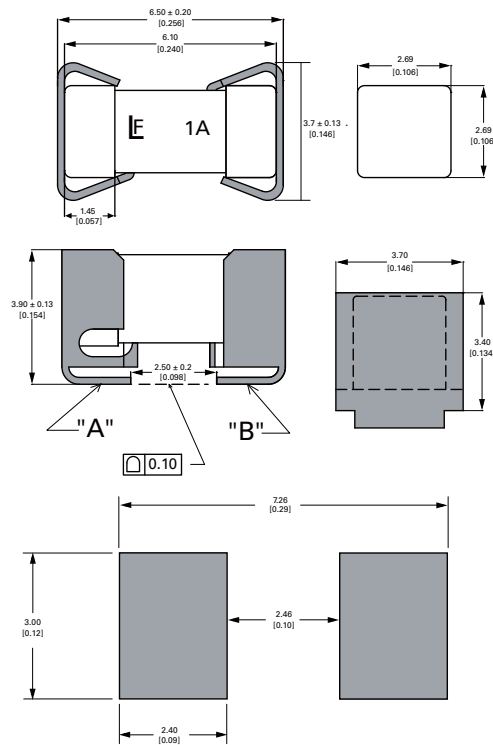

PCB Recommendation for Thermal Management

1. Minimum Copper Layer Thickness = 100µm
2. Minimum Copper Trace Width = 10mm

Note:

Alternate methods of thermal management may be used. In such cases, under normal operations, the maximum temperature of the fuse body should not exceed 80°C in a 25°C ambient environment.

Part Numbering System

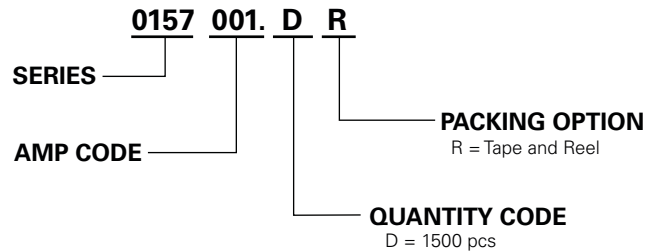

Packaging

Packaging Option	Packaging Specification	Quantity	Quantity & Packaging Code
Tape and Reel	Surface Mount	1500	DR

RoHS HF 157T Series – Standard Nano Fuse and Clip Assembly





Description

The 157T Series Fuse/Clip assembly is a small, square, Time-Lag, surface mount fuse that is assembled in surface mountable fuse clips. The unique time delay feature of this fuse design helps solve the problem of nuisance “opening” by accommodating inrush currents that normally cause a fast acting fuse to open.

The fuse clip and pre-installed fuse combination can be automatically placed in PC Board in one efficient manufacturing operation. It permits quick and easy replacement of fuses without performing desoldering process, even in the field and without exposing the PC Board to detrimental effects of rework solder heat.

Agency Approvals

AGENCY	AGENCY FILE NUMBER	AMPERE RANGE
	E14721	0.375A ~ 5A
	NBK030205-E10480A NBK030205-E10480B	1A 1.5A-5A

Electrical Characteristics for Series

% of Ampere Rating	% of Ampere Rating	Opening Time at 25°C
100%	0.375A ~ 5A	4 hours, Minimum
200%	0.375A ~ 5A	1 sec. Minimum, 60 secs. Maximum
300%	0.375A ~ 5A	0.20 secs. Minimum, 3.00 secs. Maximum
800%	0.375A ~ 5A	0.02 secs. Minimum, 0.10 secs. Maximum



Features

- Surface Mountable, Time-Lag Fuse.
- Easily replaceable on PC Board (Field Replaceable)
- Fully compatible with RoHS/Pb-Free solder alloys and higher temperature profiles associated with leadfree assembly.
- RoHS Compliant and Halogen-free
- Available in ratings of 0.375 ~ 5 Amperes.

Applications

- Instrumentations
- Base Stations
- Telecommunications

Electrical Specifications by Item

Ampere Rating (A)	Amp Code	Max Voltage Rating (V)	Interrupting Rating (A)	Fuse Furnished	Nominal Cold Resistance (Ohms)	Nominal Melting I ² t (A ² sec)	Agency Approvals	
								
0.375	.375	125	50A @ 125VAC/VDC	0454.375	1.2214	0.101	X	
0.500	.500	125		0454.500	0.7047	0.240	X	
0.750	.750	125		0454.750	0.3602	0.904	X	
1.00	001	125		0454001.	0.2245	1.98	X	X
1.50	01.5	125		045401.5	0.0934	3.65	X	X
2.00	002	125		0454002.	0.0629	8.20	X	X
2.50	02.5	125		045402.5	0.0452	15.0	X	X
3.00	003	125		0454003.	0.0342	20.16	X	X
3.50	03.5	125		045403.5	0.0226	26.53	X	X
4.00	004	125		0454004.	0.0188	34.40	X	X
5.00	005	125		0454005.	0.0138	53.72	X	X

1. Cold resistance measured at less than 10% of rated current at 23°C.
 2. I²t values stated for 8ms opening time.
 3. Agency Approval Table Key: X=Approved or Certified, P=Pending and Blank=Not Approved
 4. Have special electrical characteristic needs? Contact Littelfuse to learn more about application specific options

157T Series

Temperature Derating Curve

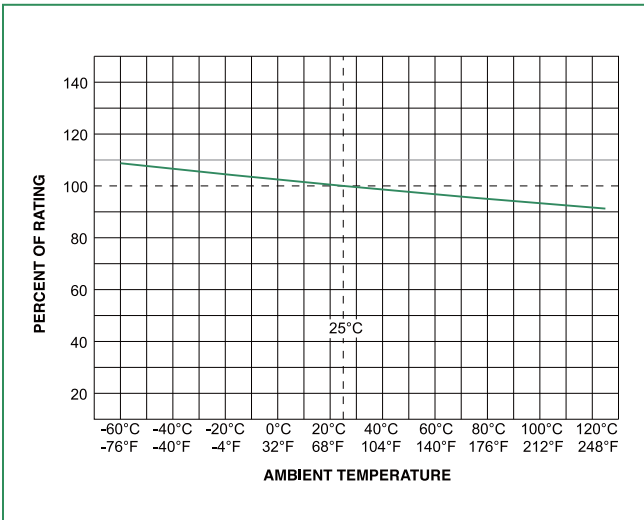

Note:

1. Derating depicted in this curve is in addition to the standard derating of 25% for continuous operation.

Average Time Current Curves

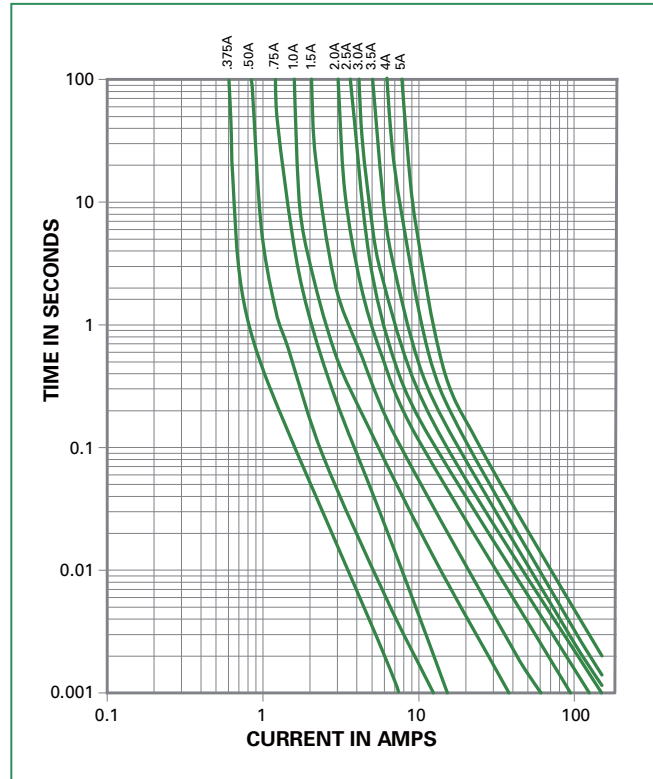

Soldering Parameters

Reflow Condition		Pb – Free assembly
Pre Heat	- Temperature Min ($T_{s(min)}$)	150°C
	- Temperature Max ($T_{s(max)}$)	200°C
	- Time (Min to Max) (t_s)	60 – 120 secs
Average ramp up rate (Liquidus Temp (T_L) to peak)		5°C/second max
$T_{s(max)}$ to T_L - Ramp-up Rate		5°C/second max
Reflow	- Temperature (T_L) (Liquidus)	217°C
	- Temperature (t_L)	60 – 90 seconds
Peak Temperature (T_p)		250 ^{+0/-5} °C
Time within 5°C of actual peak Temperature (t_p)		20 – 40 seconds
Ramp-down Rate		5°C/second max
Time 25°C to peak Temperature (T_p)		8 minutes Max.
Do not exceed		260°C

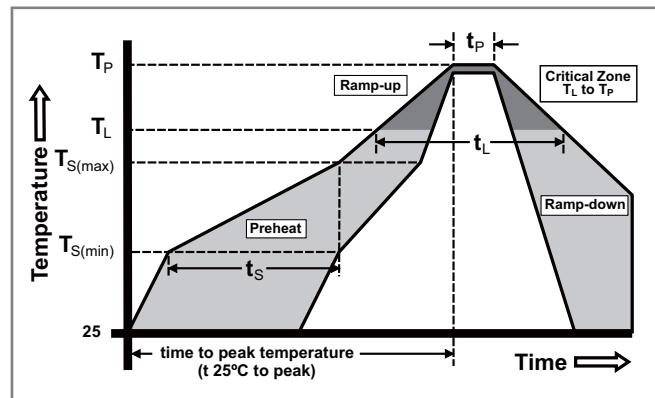

Product Characteristics

Materials	Body: Ceramic Cap: For 0.375A ~ 5A – Silver plated Brass Clip Plating: Matte Tin
Product Marking	Body: Brand Logo, Current Rating, "T" for Time-Lag
Clip Retention	Force applied at fuse center, perpendicular to the long axis (@0.75 lbs. MIN)
Solderability	MIL-STD-202, Method 208 / IPC/ EIA / JEDEC J-STD002B, Test Condition A
Humidity Test	MIL –STD-202, Method 103 @ 85°C / 85% RH, 1000 hours
Resistance to Solvents	MIL-STD-202, Method 215 (3 solvent types)

Operating Temperature	-55°C to 125°C with proper derating
Thermal Shock	MIL-STD-202, Method 107, Test Condition B (5 cycles -65°C to +125°C)
Vibration	MIL-STD-202, Method 201 (10-55 Hz)
Moisture Resistance	MIL-STD-202, Method 106, 10 cycles
Salt Spray/ Atmosphere	MIL-STD-202, Method 101, Test Condition B (48 hrs.), 5% NaCl in De-ionized Water
Shock	MIL-STD-202, Method 213, Test Condition I (100 G's peak for 6 milliseconds)

Dimensions

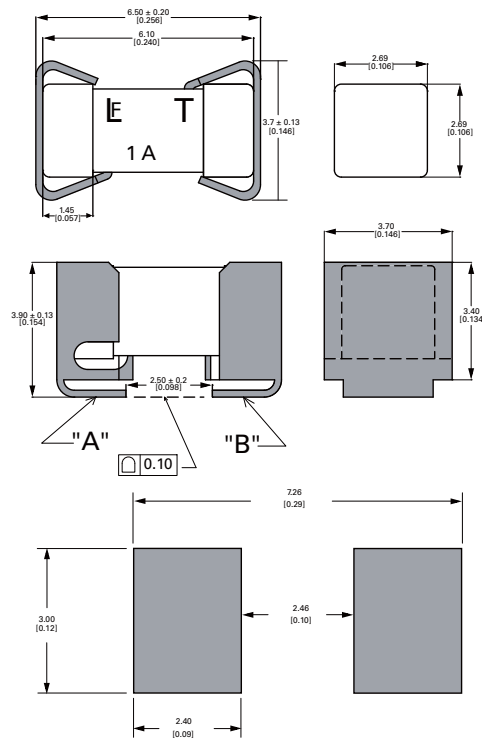

PCB Recommendation for Thermal Management

1. Minimum Copper Layer Thickness = 100um
2. Minimum Copper Trace Width = 10mm

Note:

Alternate methods of thermal management may be used. In such cases, under normal operations, the maximum temperature of the fuse body should not exceed 80°C in a 25°C ambient environment.

Part Numbering System

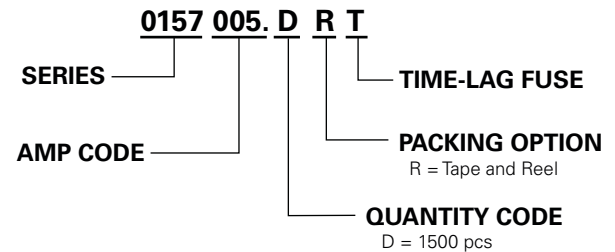

Packaging

Packaging Option	Packaging Specification	Quantity	Quantity & Packaging Code
Tape and Reel	Surface Mount	1500	DRT

RoHS HF 159 Series TeleLink® Fuse and Clip Assembly



Description

The 159 Series product is a metal fuse clip with pre-installed Littelfuse 461 Series TeleLink® fuse. This fuse and clip combination can be automatically installed in PC Boards in one efficient manufacturing operation. It permits quick and easy fuse replacement without exposing the PC Board and other components to risks of rework solder heat as required with direct surface mount fuses.

It meets UL 60950 power cross requirements and is designed to allow compliance with Telcordia GR-1089-CORE and TIA-968-A Surge Specifications. The product provides coordinated protection with Littelfuse SIDACTor® protection thyristors without series resistors.

Agency Approvals

AGENCY	AGENCY FILE NUMBER	AMPERE RANGE
	E14721	0.5A, 1.25A, 2.0A

Electrical Characteristics for Series

% of Ampere Rating	Opening Time
100%	4 hours, Minimum
250%	1 sec., Minimum 120 secs., Maximum

Features

- Offer low profile easily-replaceable fuse alternative compatible with automated PCB surface mount equipment
- Come supplied with surge resistant Littelfuse 461 series TeleLink® Time-Lag Slo-Blo® fuse
- Fuse designed to allow compliance with Telcordia GR-1089-CORE and TIA-968-A (formerly FCC Part 68) Surge Specifications
- Provide coordinated protection with Littelfuse SIDACTor® devices and GDTs, without series resistors
- RoHS compliant and Halogen Free
- Clip fully compatible with RoHS/lead-free solder alloys and higher temperature profiles associated with lead-free assembly
- Available in ratings of 0.5-2.0 Amperes

Applications

- Telecom equipment (POTS) applications such as modems, answering machines, telephones, fax machines, and security systems
- Network equipment, such as:
 - SLIC interface portion of Fiber to the Curb (FTTC) and Fiber to the Premises (FTTP)
 - Non-Fiber SLIC interface for Central Office (CO) locations and Remote Terminals (RT)
 - xDSL applications such as ADSL, ADSL2+, VDSL, and VDSL2+
 - Ethernet 10/100/1000BaseT
 - ISDN "U" interface
 - Baystation T1/E1/J1, T3 (DS3) trunk cards

Electrical Specifications by Item

Ampere Rating (A)	Amp Code	Max Voltage Rating (V)	Interrupting Rating	Nominal Cold Resistance (Ohms)	Nominal Melting I ² t (A ² sec)	Agency Approvals
						
0.50	.500	600	60 A @600 VAC	0.560	0.840 ¹	x
1.25	1.25	600		0.110	16.5 ¹	x
2.00	002.	600		0.050	17.5 ¹	x

¹ I²t is calculated at 10 msec. or less. I²t at 10 times rated current has a typical value of: 24 A²sec (2.0A), 22 A²sec (1.25A), 1.3 A²sec (0.5A).

- Typical inductance < 40nH up to 500 MHz.
- Resistance changes 0.5% for every °C.
- Resistance is measured at 10% rated current.

Temperature Derating Curve

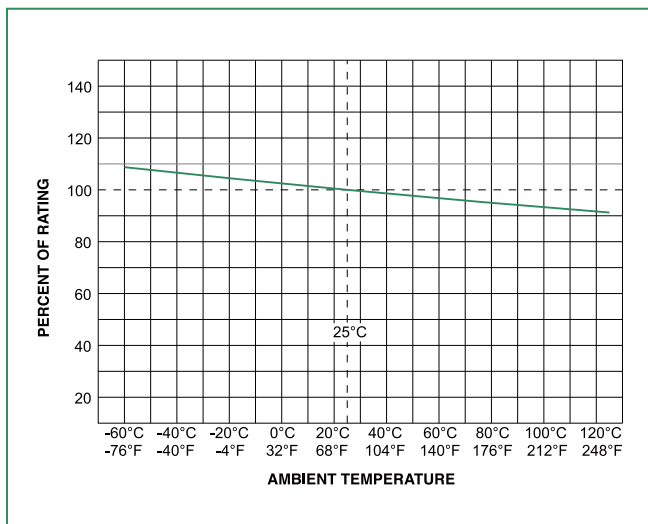

Note:

1. Derating depicted in this curve is in addition to the standard derating of 25% for continuous operation.

Maximum Temperature Rise

Telecom Nano ² ® Fuse	Opening Time
04611.25	≤82°C (180°F)
046002	≤50°C (122°F)

Average Time Current Curves

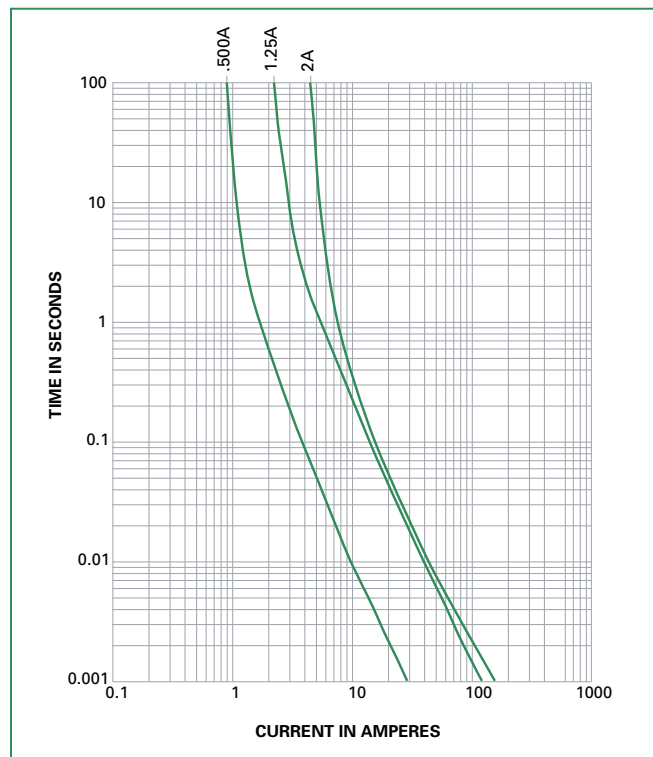

TIA-968-A (formerly FCC part 68) Surge Waveforms

(fuse can not open during type B events)

Surge	Voltage (V)	Waveform (μs)	Current (A)	Repetitions	Recommended Fuse
Metallic A	800	10 x 560	100	1 ea. polarity	1.25
Longitudinal A	1500	10 x 160	200	1 ea. polarity	1.25
Metallic B	1000	9 x 720	25	1 ea. polarity	1.25
Longitudinal B	1500	9 x 720	37.5	1 ea. polarity	1.25

For the type A events the 0.5 fuse will open, providing non-operational compliance. The 1.25 & 2.0 will not open, providing for operational compliance with TIA-968-A type A surge events.

GR 1089 Inter-building requirements

GR 1089 1st level lighting surge inter-building

(Equipment under test can not be damaged and must continue to operate properly)

Surge	Minimum Peak Voltage (V)	Minimum Peak Current (A)	Max. Rise/Min. Decay (μs)	Repetitions Each Polarity	Fuse Choices
1	600	100	10/1000	25	1.25, 2.0
2	1000	100	10/360	25	1.25, 2.0
3	1000	100	10/1000	25	1.25, 2.0
4	2500	500	2/10	10	1.25, 2.0
5	1000	25	10/360	5	0.5, 1.25, 2.0

If sufficient series resistance is used, then the 0.5 fuse may be used in test conditions 1-4.

GR 1089 AC power fault 1st level inter-building (fuse not allowed to open)

Test	Vrms	Short Circuit Current (A)	Hits	Duration	Primary Protector	Fuse Choices
1	50	.33	1	15 min.	removed	1.25, 2.0
2	100	.17	1	15 min.	removed	1.25, 2.0
3	200,400, 600	1	60	1 sec.	removed	1.25, 2.0
4	1000	1	60	1 sec.	operative	1.25, 2.0
5	Diagram	Diagram	60	5 secs.	removed	1.25, 2.0
6	600	0.5	1	30 secs.	removed	1.25, 2.0
7	440	2.2	5	2 secs.	removed	1.25, 2.0
8	600	3	1	1.1 secs.	removed	1.25, 2.0
9	1000	5	1	0.4 sec.	in place	1.25, 2.0

GR 1089 2nd level lightning surge telecom port

(Equipment under test shall not become a fire, fragmentation, or electrical safety hazard)

Surge	Minimum Peak Voltage (V)	Minimum Peak Current (A)	Max. Rise/Min. Decay (μs)	Repetitions Each Polarity	Fuse Choices
1	5000	500	2/10	1	0.5, 1.25, 2.0
Alternative	5000	500/8=625	8/10	1	0.5, 1.25, 2.0

The 0.5 fuse will open during these test conditions. The 1.25 & 2.0 will not open thus providing operational compliance.

GR 1089 AC power fault 2nd level (fuse can open but must open in a safe and controlled manner)

Test Circuite	Vrms	Short (A)	Duration	Fuse
1	120,277	25	15 min.	0.5, 1.25, 2.0
2	600	60	5 secs.	0.5, 1.25, 2.0
3	600	7	5 secs.	0.5, 1.25, 2.0
4	100-600	2.2	15 min..	0.5, 1.25, 2.0
5	Diagram	Diagram	15 min.	0.5, 1.25, 2.0

Fuse must open before wiring simulator fuse (MDL 2.0).

UL60950 Requirements

UL 60950 (EN 60950, formerly UL 1950) Power Cross Test (L=Longitudinal, M=Metallic)

Test Number	Voltage (V)	Current (A)	Time	Fuse Choices
L1	600	40	1.5 secs.	0.5, 1.25, 2.0
L2	600	7	5 secs.	0.5, 1.25, 2.0
L3	600	2.2	30 min.	0.5, 1.25, 2.0
L4	200	2.2	30 min.	0.5, 1.25, 2.0
L5	120	25	30 min.	0.5, 1.25, 2.0
M1	600	40	1.5 secs.	0.5, 1.25, 2.0
M2	600	7	5 secs.	0.5, 1.25, 2.0
M3	600	2.2	30 min.	0.5, 1.25, 2.0
M4	600	2.2	30 min.	0.5, 1.25, 2.0

Selection of test number depends on current limiting F fire enclosure/spacing of end product

- 26 AWG line cord removes L1/M1 test requirement
 - L5 conducted only if product does not pass section 6.1.2
 - L2,M2,L3,M3,L4,M4 conducted if not in a fire enclosure
- Fuse must open before the wiring simulator fuse (MDL 2.0).

UL 60950 (EN 60950, formerly UL 1950) Impulse Test and Steady-State Electric Strength Test

Test	Voltage (V)	Current (A)	Waveform	Repetitions	Fuse Choices
Impulse					
For handheld units	2500	62.5	10 x 700ms	+ 10 w/60 secs. rest	0.5, 1.25, 2.0
Non handheld	1500	37.5	10 x 700ms	+ 10 w/60 secs. rest	0.5, 1.25, 2.0
Steady-State					
For handheld units	1500		60Hz		0.5, 1.25, 2.0
Non handheld	1000		60Hz		0.5, 1.25, 2.0

Soldering Parameters

Reflow Condition		Pb – free assembly
Pre Heat	- Temperature Min ($T_{s(min)}$)	150°C
	- Temperature Max ($T_{s(max)}$)	200°C
	- Time (Min to Max) (t_s)	60 – 120 seconds
Average Ramp-up Rate (Liquidus Temp (T_L) to peak)		3°C/second max.
$T_{s(max)}$ to T_L - Ramp-up Rate		3°C/second max.
Reflow	- Temperature (T_L) (Liquidus)	217°C
	- Temperature (t_L)	60 – 90 seconds
Peak Temperature (T_p)		250 ^{+0/-5} °C
Time within 5°C of actual peak Temperature (t_p)		20 – 40 seconds
Ramp-down Rate		6°C/second max.
Time 25°C to peak Temperature (T_p)		8 minutes max.
Do not exceed		260°C

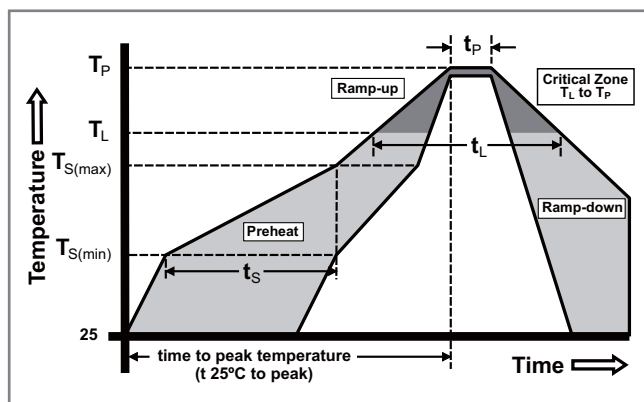

Part Numbering System

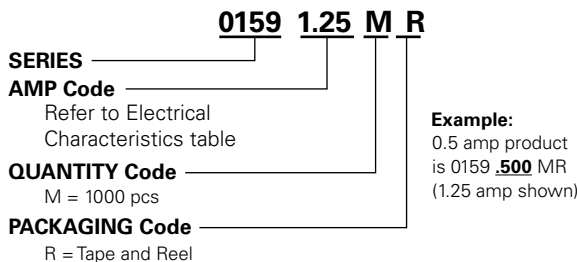

Product Characteristics

Materials	Fuse Body: Ceramic Fuse Caps/Terminals: Silver-plated Brass Clip Base: Gold-plated Clip Terminals: Nickel-plated
Product Marking	Brand Logo, Current Rating, 'T'
Insulation Resistance (after opening)	MIL-STD-202, Method 302, Test condition A (10,000 ohms, minimum)
Operating Temperature	-55°C to 125°C with proper rerating
Humidity Test	85°C/ 85% RH, 1000 hours
Solderability	MIL-STD-202, Method 208/IPC EIA J-STD002A, Test Condition A
Resistance to Solvents	MIL-STD-202, Method 215 (3 solvent types)
Thermal Shock	MIL-STD-202, Method 107G, Test Condition B3 (95 cycles -65°C to +125°C)
Mechanical Shock	MIL-STD-202, Method 213, Test Condition I (100G's peak for 6 msec.)
Vibration	MIL-STD-202, Method 201, (10-55 Hz)
Moisture Resistance	MIL-STD-202, Method 106, High Humidity (90-98% RH), Heat (65°C)
Salt Spray/ Atmosphere	MIL-STD-202F, Method 101, Test Condition B (48 hours)
Terminal Attachment	MIL-STD-202, Method 211, Test Condition A, 5 lbs applied to end caps

Dimensions

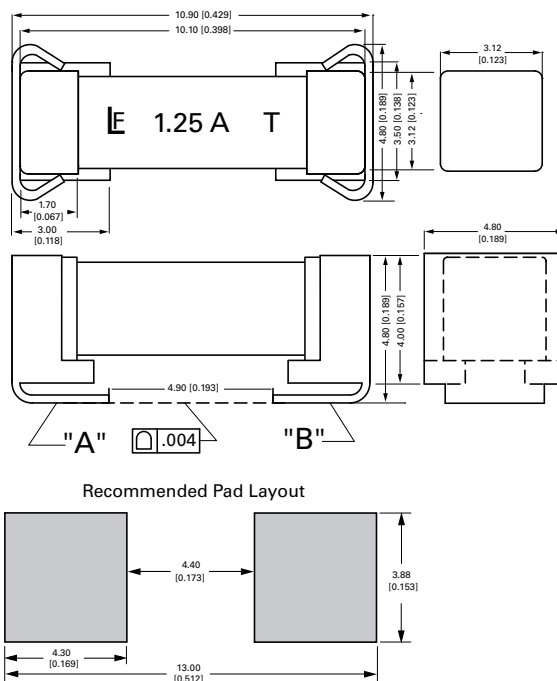

Packaging

Packaging Option	Packaging Specification	Quantity	Quantity & Packaging Code
24mm Tape and Reel	EIA RS-481-2 (IEC 286, part 3)	1000	MR

RoHS 459 Series PICO® Very Fast-Acting Surface Mount Fuse

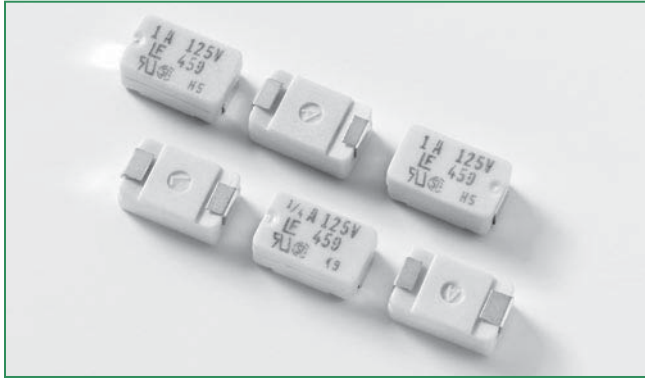

Description

The 459 Series Very Fast-Acting SMF is based on Littelfuse PICO® fuse technology, though offered in a surface mount package.

This series of devices meets the requirements of the RoHS directive.

Features

- Very Fast-Acting
- Wide current rating range: 62mA to 5A
- Wide operating temperature range
- Low temperature rerating
- RoHS compliant

Applications

- Wireless basestation
- Network equipment
- Telecom equipment

Agency Approvals

AGENCY	AGENCY FILE NUMBER	AMPERE RANGE
	E10480	62mA - 5A
	LR29862	62mA - 5A

Electrical Characteristics for Series

% of Ampere Rating	Opening Time
100%	4 hours, Minimum
200%	1 second, Maximum
300%	0.1 second, Maximum

Electrical Specifications by Item

Ampere Rating (A)	Amp Code	Max Voltage Rating (V)	Interrupting Rating	Nominal Cold Resistance (Ohms)	Nominal Melting I ² t (A ² sec)	Agency Approvals	
0.062	.062	125	50 A @125 VAC 300 A @125 VDC	7.0000	0.000075	x	x
0.125	.125	125		1.7000	0.00163	x	x
0.250	.250	125		0.6650	0.0106	x	x
0.375	.375	125		0.3950	0.0254	x	x
0.500	.500	125		0.2800	0.0546	x	x
0.750	.750	125		0.1750	0.155	x	x
1.00	001.	125		0.1250	0.281	x	x
1.50	01.5	125		0.0800	0.650	x	x
2.00	002.	125		0.0468	0.421	x	x
2.50	02.5	125		0.0350	0.721	x	x
3.00	003.	125		0.0290	1.23	x	x
3.50	03.5	125		0.0240	1.65	x	x
4.00	004.	125		0.0200	2.35	x	x
5.00	005.	125		0.0155	3.90	x	x

Temperature Rerating Curve

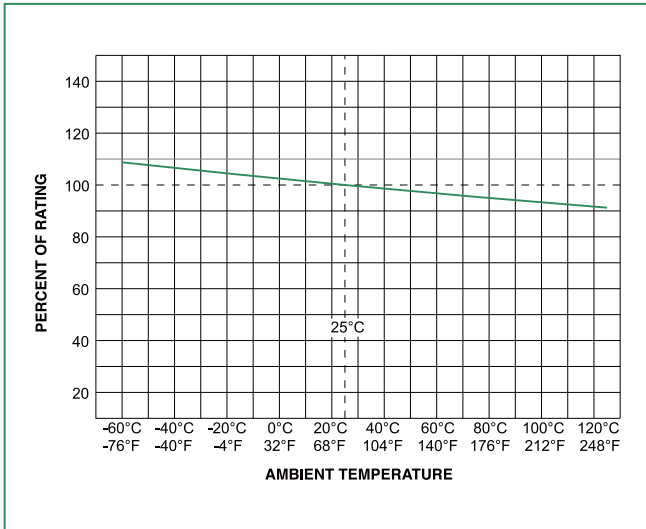

Note:

1. Rerating depicted in this curve is in addition to the standard rerating of 25% for continuous operation.

Average Time Current Curves

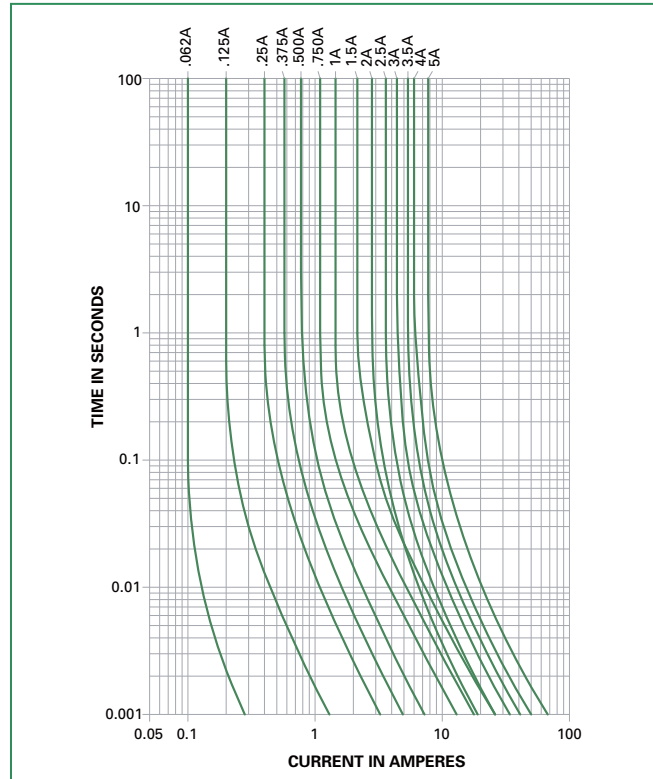

Soldering Parameters

Wave Soldering	260°C, 10 seconds max.
Reflow Soldering	260°C, 30 seconds max.

Product Characteristics

Materials	Body: Molded Thermoplastic Terminations: 100% Tin-plated Copper (459 Series)
Solderability	MIL-STD-202, Method 208
Product Marking	Body: Brand Logo, Current Rating, Voltage Rating, Series Code, Date Code, Agency Approved Logo
Moisture Sensitivity Level	Level 1 J-STD - 020C

Operating Temperature	-55°C to 125°C
Shock	MIL-STD-202, Method 213, Test Condition I (100 G's peak for 6 msecs.)
Vibration	MIL-STD-202, Method 201 (10-55 Hz, 0.06 inch total excursion)
Salt Spray	MIL-STD-202, Method 101, Test Condition B (48 hours)
Insulation Resistance (After Opening)	MIL-STD-202, Method 302, (10,000 ohms minimum at 100 volts)
Thermal Shock	MIL-STD-202, Method 107, Test Condition B (-65 to 125°C)
Moisture Resistance	MIL-STD-202, Method 106, High Humidity (90-98 RH), Heat (65°C)

Dimensions

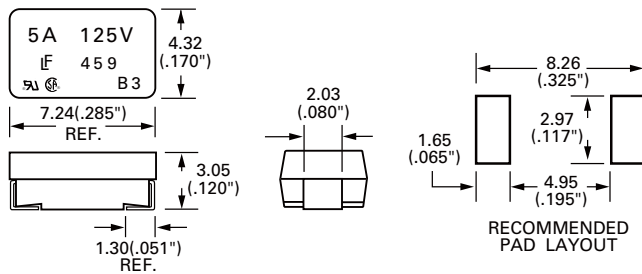

Part Numbering System

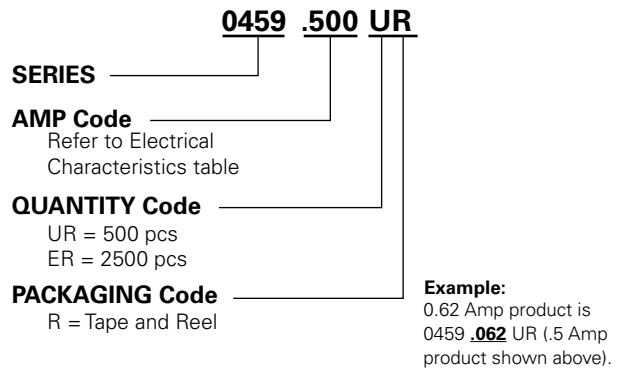

Packaging

Packaging Option	Packaging Specification	Quantity	Quantity & Packaging Code
12mm Tape and Reel	EIA RS-481-1 (IEC 286, part 3)	500	UR
12mm Tape and Reel	EIA RS-481-1 (IEC 286, part 3)	2500	ER

RoHS HF 460 Series PICO® Slo-Blo® Surface Mount Fuse

Description

The 460 Series Slo-Blo® SMF is based on Littelfuse PICO® fuse through-hole technology, though offered in a surface mount package.

This series of devices meets the requirements of the RoHS directive.



Features

- Slow-Blow
- High inrush current withstand capability
- Wide current rating range: 0.375A to 5A
- Wide operating temperature range
- RoHS compliant

Applications

- Wireless basestation
- Network equipment
- Telecom equipment



Agency Approvals

AGENCY	AGENCY FILE NUMBER	AMPERE RANGE
	E10480	0.375A - 5A
	LR29862	0.375A - 5A
	NBK181103-E10480	1A - 5A

Electrical Characteristics for Series

% of Ampere Rating	Opening Time
100%	4 hours, Minimum
200%	1 second, Min.; 120 seconds, Max.
300%	0.2 second, Min.; 3 seconds, Max.
800%	0.02 second, Min.; 0.1 second, Max.

Electrical Specifications by Item

Ampere Rating (A)	Amp Code	Max Voltage Rating (V)	Interrupting Rating	Nominal Cold Resistance (Ohms)	Nominal Melting I ² t (A ² sec)	Agency Approvals		
								
0.375	.375	125	50 A @125 VAC 50 A @125 VDC	1.7400	0.085	x	x	
0.500	.500	125		1.1900	0.210	x	x	
0.750	.750	125		0.4970	0.760	x	x	
1.00	001.	125		0.2800	2.01	x	x	x
1.50	01.5	125		0.1160	3.94	x	x	x
2.00	002.	125		0.0710	7.60	x	x	x
2.50	02.5	125		0.0520	13.0	x	x	x
3.00	003.	125		0.0380	21.0	x	x	x
3.50	03.5	125		0.0240	26.8	x	x	x
4.00	004.	125		0.0194	35.0	x	x	x
5.00	005.	125		0.0133	54.8	x	x	x

Temperature Rerating Curve

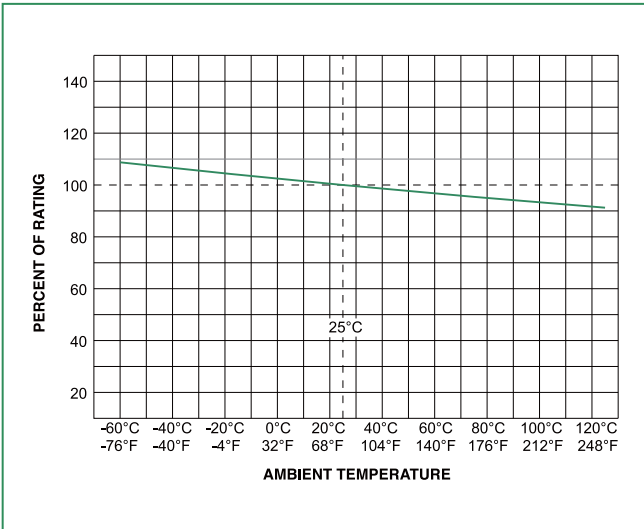

Note:

1. Rerating depicted in this curve is in addition to the standard rerating of 25% for continuous operation.

Average Time Current Curves

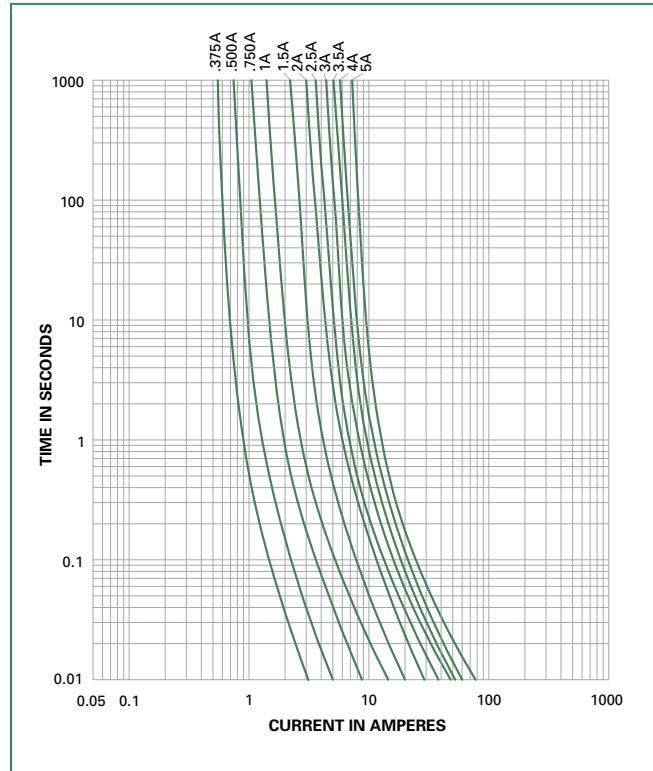

Soldering Parameters

Wave Soldering	260°C, 3 seconds max.
Reflow Soldering	230°C, 30 seconds max.

Product Characteristics

Materials	Body: Molded Thermoplastic Terminations: 100% Tin-plated Copper (460 Series)
Solderability	MIL-STD-202, Method 208
Product Marking	Body: Brand Logo, Current Rating, Voltage Rating, Series Code, Date Code, Agency Approved Logo
Moisture Sensitivity Level	Level 1 J-STD - 020C

Operating Temperature	-55°C to 125°C
Shock	MIL-STD-202, Method 213, Test Condition I (100 G's peak for 6 msecs.)
Vibration	MIL-STD-202, Method 201 (10-55 Hz, 0.06 inch total excursion)
Salt Spray	MIL-STD-202, Method 101, Test Condition B (48 hours)
Insulation Resistance (After Opening)	MIL-STD-202, Method 302, (10,000 ohms minimum at 100 volts)
Thermal Shock	MIL-STD-202, Method 107, Test Condition B (-65°C to 125°C)
Moisture Resistance	MIL-STD-202, Method 106, High Humidity (90-98 RH), Heat (65°C)

Dimensions

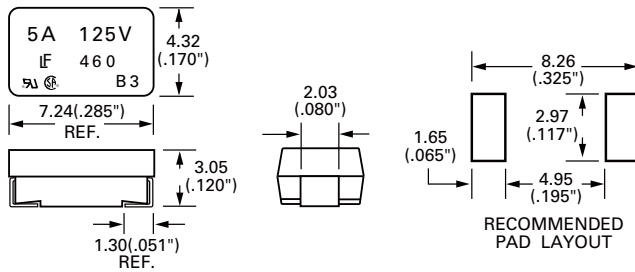

Part Numbering System

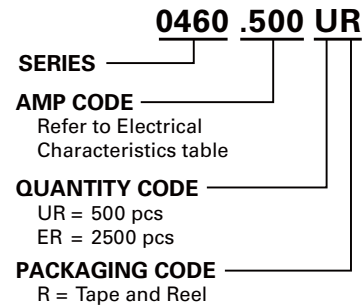

Example:
1 Amp product is 0460 .001 UR (.5 Amp product shown above).

Packaging

Packaging Option	Packaging Specification	Quantity	Quantity & Packaging Code
12mm Tape and Reel	EIA RS-481-1 (IEC 286, part 3)	500	UR
12mm Tape and Reel	EIA RS-481-1 (IEC 286, part 3)	2500	ER

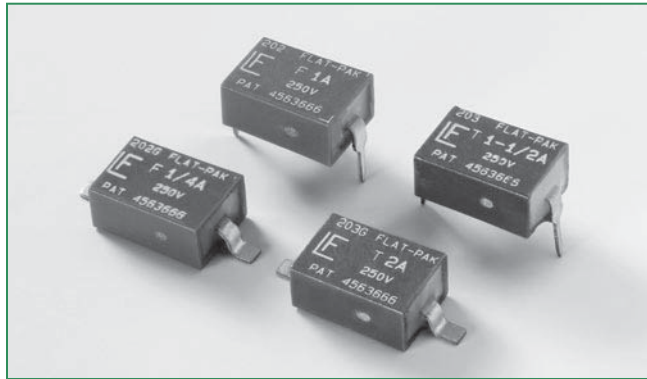

202 Series Fuse



Description

Fast-Acting and Slo-Blo® Fuse versions of the Flat-Pak® Fuse designs are available. Both designs are available in either a gull-wing surface mount package or a DIP configuration for through-hole mounting. These fuse designs feature a 250 VAC rating in a low profile, rectangular package.



Agency Approvals

AGENCY	AGENCY FILE NUMBER	AMPERE RANGE
	E10480	1/16mA - 5A
	LR29862	1/16mA - 5A

Electrical Characteristics for Series

% of Ampere Rating	Opening Time
100%	4 hours, Minimum
200%	2 seconds, Maximum

Electrical Specifications by Item

Ampere Rating (A)	Amp Code	Max Voltage Rating (V)	Interrupting Rating	Nominal Cold Resistance (Ohms)	Nominal Melting I ² t (A ² sec)	Agency Approvals	
							
0.062	.062	250	50 amperes @250 VAC	7.9000	0.000220	x	x
0.125	.125	250		2.4500	0.00180	x	x
0.250	.250	250		0.8800	0.0147	x	x
0.500	.500	250		0.2980	0.0363	x	x
0.750	.750	250		0.1660	0.0980	x	x
1.00	001.	250		0.1190	0.192	x	x
1.50	015.	250		0.0701	0.540	x	x
2.00	002.	250		0.0469	1.07	x	x
2.50	02.5	250		0.0455	1.76	x	x
3.00	003.	250		0.0327	1.71	x	x
4.00	004.	250		0.0244	3.00	x	x
5.00	005.	250		0.0174	4.68	x	x

Temperature Derating Curve

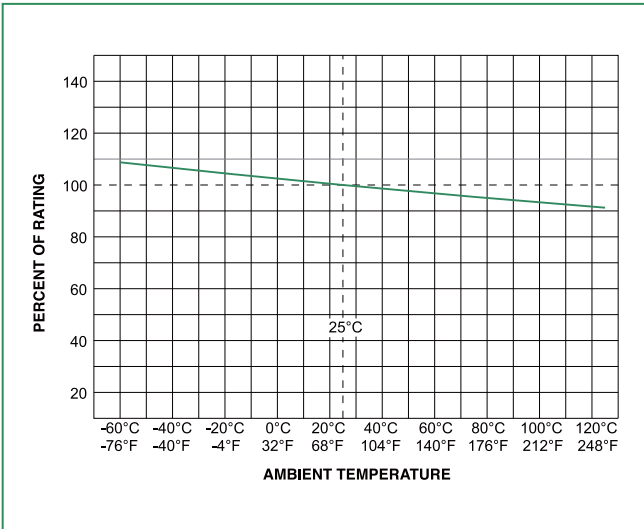

Note:

1. Derating depicted in this curve is in addition to the standard derating of 25% for continuous operation.

Average Time Current Curves

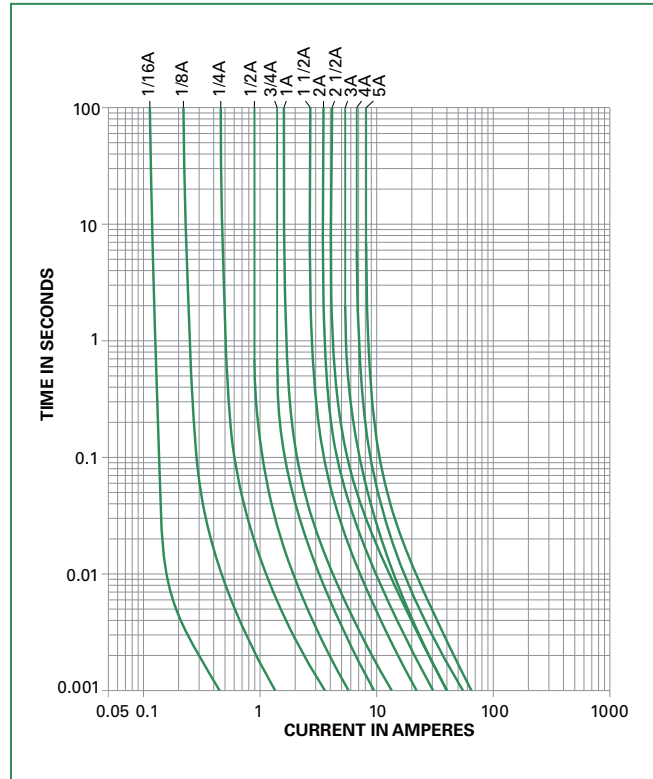

Soldering Parameters

Wave Soldering	260°C, 3 seconds max.
Reflow Soldering	215°C, 30 seconds max.

Product Characteristics

Materials	Body: Thermoplastic Terminations: Tin/Lead Plated Copper
Solderability	MIL-STD-202, Method 208.

Cleaning	Board washable in most common solvents.
Operating Temperature	-55°C to 125°C

Dimensions

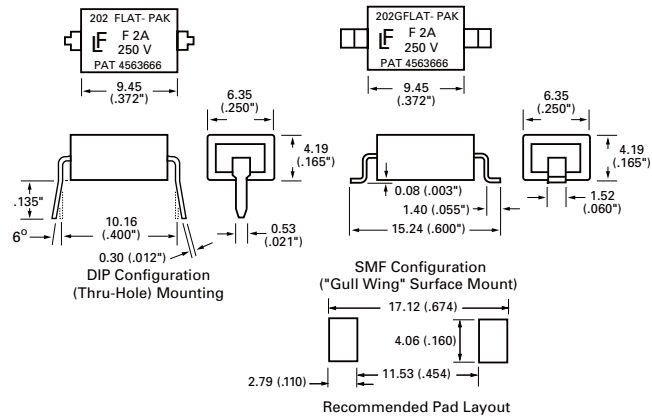

Part Numbering System

Surface Mount Fuses:

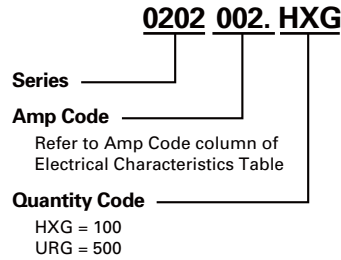

Through Hole Fuses:

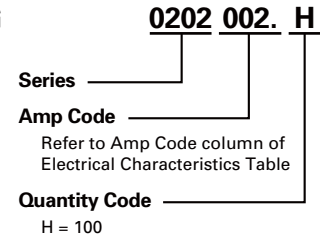

Packaging

Packaging Option	Packaging Specification	Quantity	Quantity & Packaging Code
Surface Mount Fuses			
Bulk	—	100	HXG
24mm Tape and Reel	EIA RS-481-2 (IEC 286, part 3)	500	URG
Through Hole Fuses			
Antistatic Magazine	—	100	H

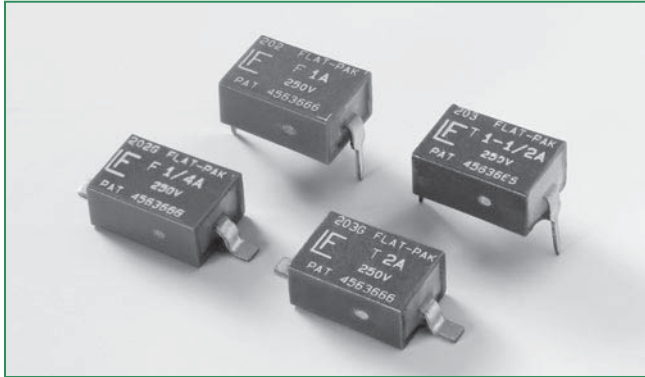

203 Series Fuse



Description

Fast-Acting and Slo-Blo® Fuse versions of the Flat-Pak Fuse designs are available. Both designs are available in either a gull-wing surface mount package or a DIP configuration for through-hole mounting. These fuse designs feature a 250 VAC rating in a low profile, rectangular package.



Agency Approvals

AGENCY	AGENCY FILE NUMBER	AMPERE RANGE
	E10480	1/4mA - 5A
	LR29862	1/4mA - 5A

Electrical Characteristics for Series

% of Ampere Rating	Opening Time
100%	4 hours, Minimum
200%	1 second, Min; 30 seconds Max.

Electrical Specifications by Item

Ampere Rating (A)	Amp Code	Max Voltage Rating (V)	Interrupting Rating	Nominal Cold Resistance (Ohms)	Nominal Melting I ² t (A ² sec)	Agency Approvals	
							
0.25	.250	250	50 amperes @250 VAC	1.36	0.0126	x	x
0.50	.500	250		0.433	0.112	x	x
0.75	.750	250		0.158	0.327	x	x
1.00	001.	250		0.0755	0.328	x	x
1.50	01.5	250		0.0390	0.850	x	x
2.00	002.	250		0.0345	1.70	x	x
2.50	02.5	250		0.0237	2.87	x	x
3.00	003.	250		0.0197	4.40	x	x
4.00	004.	250		0.0148	8.75	x	x
5.00	005.	250		0.0124	14.7	x	x

Temperature Derating Curve

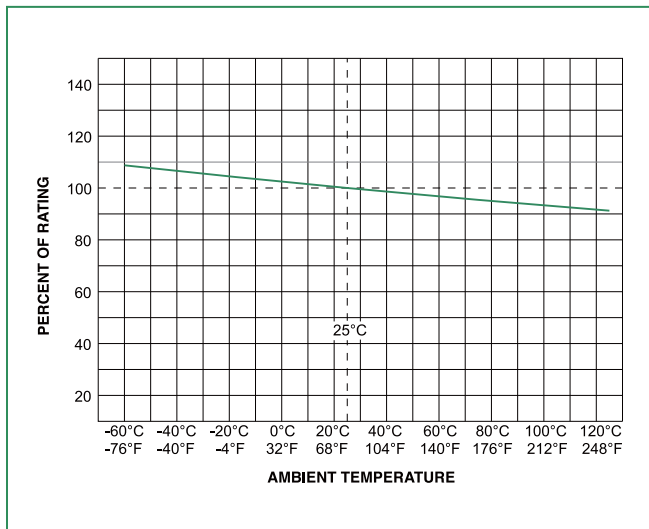

Note:

- Derating depicted in this curve is in addition to the standard derating of 25% for continuous operation.

Average Time Current Curves

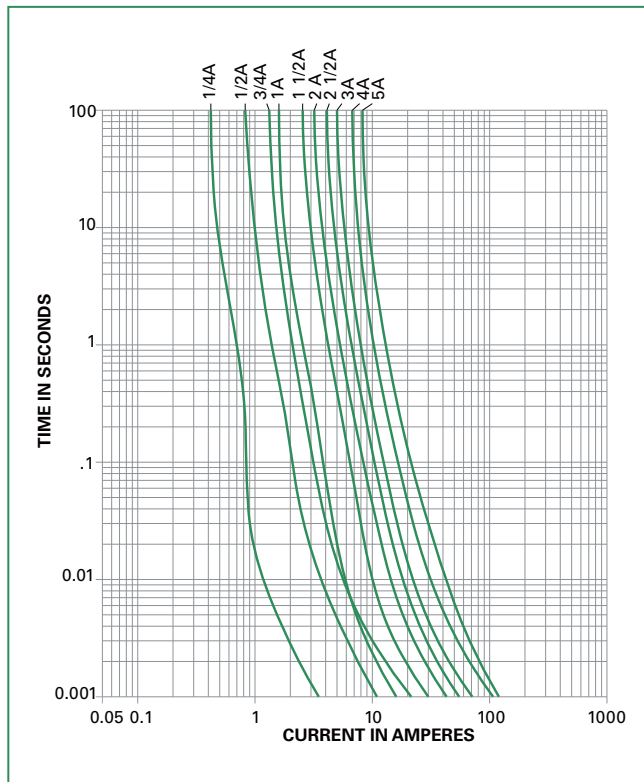

Soldering Parameters

Wave Soldering	260°C, 3 seconds max.
Reflow Soldering	215°C, 30 seconds max.

Product Characteristics

Materials	Body: Thermoplastic Terminations: Tin/Lead Plated Copper
Solderability	MIL-STD-202, Method 208

Cleaning	Board washable in most common solvents
Operating Temperature	-55°C to 125°C

Dimensions

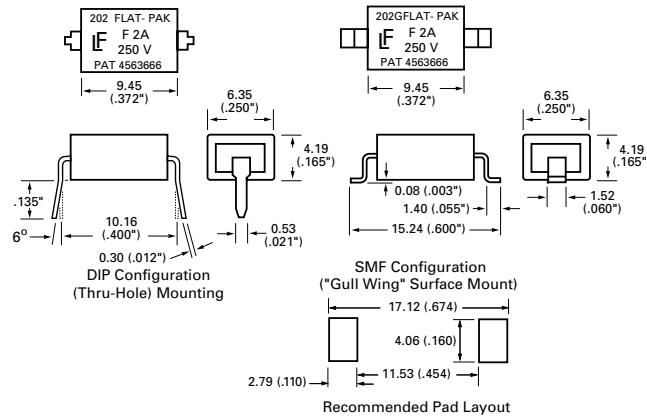

Part Numbering System

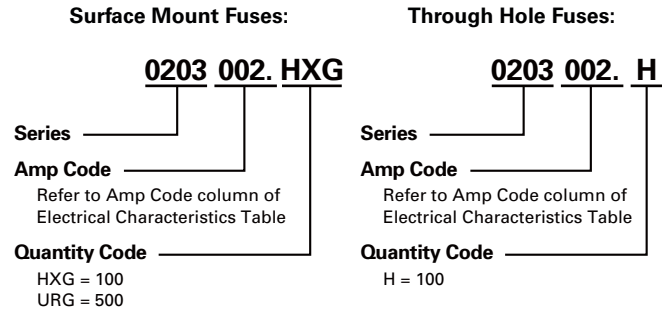

Packaging

Packaging Option	Packaging Specification	Quantity	Quantity & Packaging Code
Surface Mount Fuses			
Bulk	-	100	HXG
24mm Tape and Reel	EIA RS-481-2 (IEC 286, part 3)	500	URG
Through Hole Fuses			
Antistatic Magazine	-	100	H

203 Series

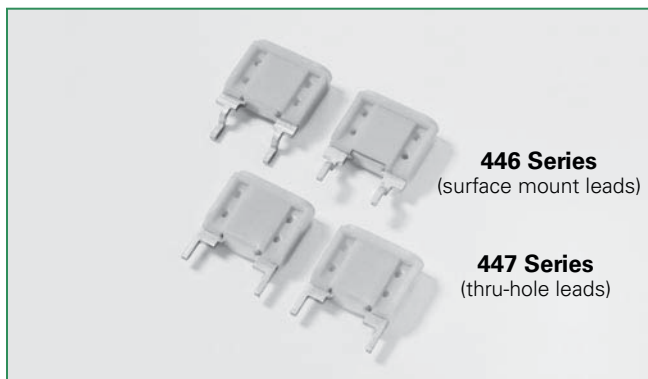
RoHS **Pb** **446/447 Series Fuse**

Description

The 446/447 series are circuit-board mountable, flat profile, fast-acting fuses designed for protection of electronic ballasts and power inverter applications. The 446 series is designed with leads for surface mount applications, and the 447 series is designed with leads for through-hole applications.

This series of devices are 100% lead-free and meets the requirements of the RoHS directive.

Features

- RoHS compliant and 100% lead-free
- Ideal for use in electronic lighting ballast, power supply and power inverter applications.
- Rated for use in 125, 250, 277 and 350 VAC circuits.
- Based on the proven reliability of the automotive MINI® Fuse; available from 2 through 10 amperes.

Agency Approvals

AGENCY	AGENCY FILE NUMBER	AMPERE RANGE
	E71611	2A - 10A
	LR29862	2A - 10A

Electrical Characteristics for Series

% of Ampere Rating	Opening Time
100%	4 hours, Minimum
200%	0.15 sec. Min.; 5 sec. Max.

Electrical Specifications by Item

Ampere Rating (A)	Amp Code	Max Voltage Rating (V)	Interrupting Rating	Nominal Cold Resistance (Ohms)	Nominal Melting I ² t (A ² sec)	Agency Approvals	
2.00	002.	350	100 amperes @350 VAC, 50 amperes @125 VDC and 450 amperes @60VDC	0.0560	2.8	x	x
3.00	003.	350		0.0340	9.4	x	x
4.00	004.	350		0.0240	17	x	x
5.00	005.	350		0.0180	25	x	x
7.50	07.5	350		0.0110	68	x	x
10.0	010.	350		0.0073	93	x	x

446/447 Series

Temperature Derating Curve

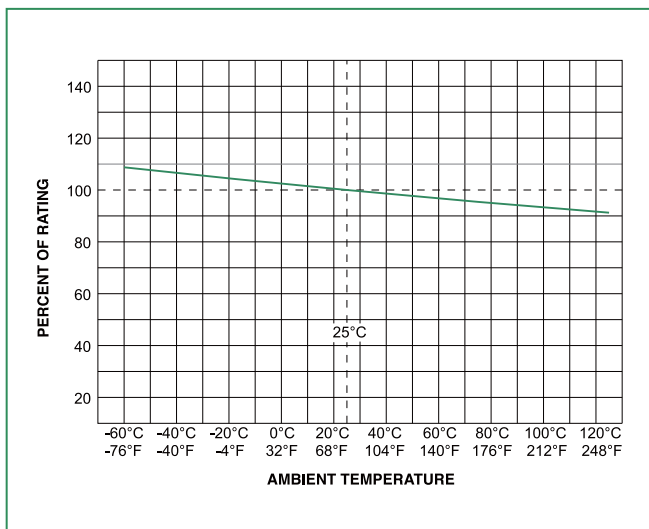

Note:

1. Derating depicted in this curve is in addition to the standard derating of 25% for continuous operation.

Average Time Current Curves

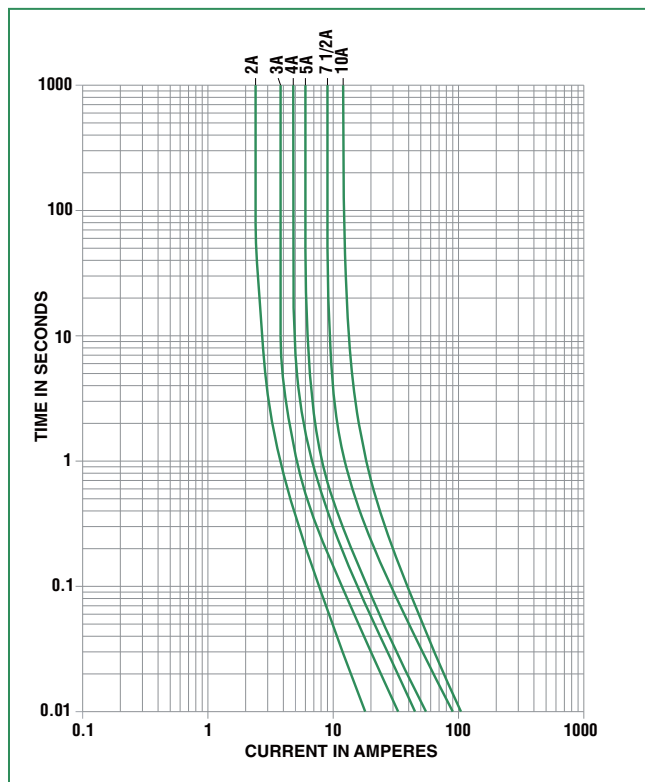

Soldering Parameters

446 Series:

Reflow Solder — 235°C, 5 seconds maximum.
 No-clean process recommended.
 Wave Solder — Not recommended.
 Non-plated terminal surfaces may not meet MIL-STD-202, Method 208.

447 Series:

Contact Littelfuse for soldering parameters.
 Inside terminal face of each lead is non-plated zinc. Non-plated zinc terminal faces may not meet MIL-STD-202, method 208. To ensure that the fuse is acceptable for the application, appropriate application testing should be performed.

Product Characteristics

Materials	Body: Plastic Body – Terminations: Tin-load (95/5) plated Zn, Ni barrier
Cleaning	No-cleaning process recommended

Operating Temperature	-40°C to 125°C
------------------------------	----------------

Dimensions

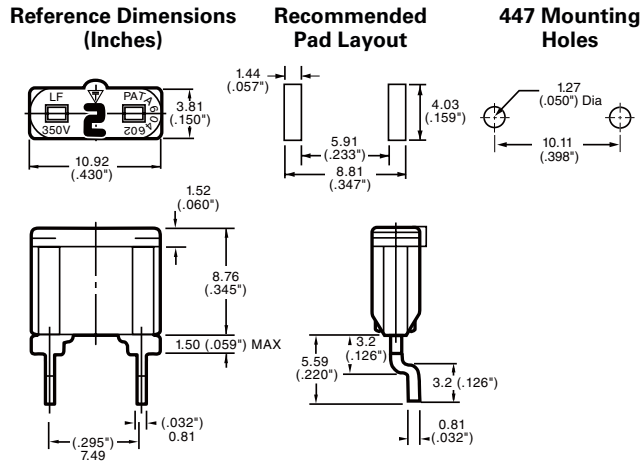

For 447 dimensions, please contact Littelfuse for specifications.

Part Numbering System

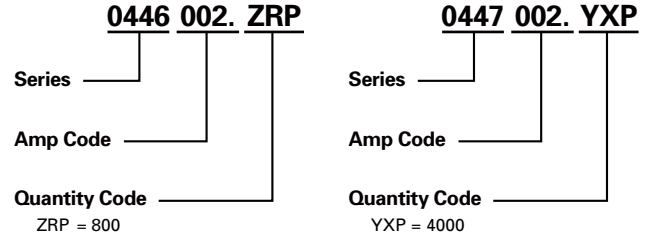

446/447 Series

Packaging

Packaging Option	Packaging Specification	Quantity	Quantity & Packaging Code
446 Series			
24mm Tape and Reel	EIA RS-481-1 (IEC 286, part 3)	800	ZRP
447 Series			
Bulk Pack	–	4000	YXP

262/268/269 Series, MICRO™ Very Fast-Acting Fuse (High-Reliability)

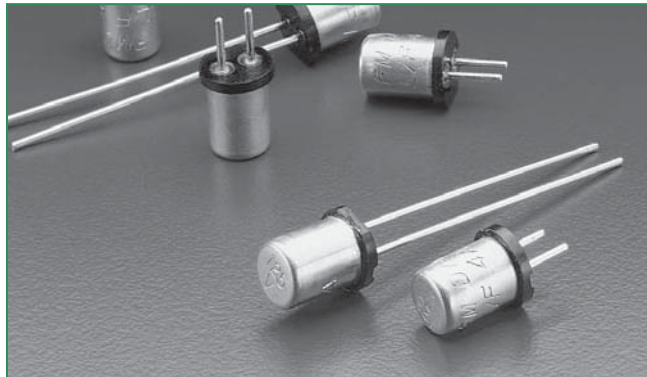

Description

The 262/268/269 Series are high-reliability micro fuses, with a 125V rating, very fast-acting type with high breaking capacity. This series is listed under the Department of Defense Quality Product List.



Features

- Military grade available
- Available in plug-in and radial leaded
- Available from very low ampere of 2mA to 5A

Applications

Protection of electrical, electronic, and communication equipment having printed circuit boards (PCBs) usable in direct current (DC) and alternating current (AC) (up to 400 hertz (Hz)) circuits capable of withstanding and functioning in extreme conditions found in Spacecraft or Military applications as described in MIL-PRF-23419.



Agency Approvals

Agency	Agency File Number	Ampere Range
	E10480	2mA - 5A
	LR 29862	2mA - 5A
	FM07A	2mA - 5A

Electrical Characteristics

% of Ampere Rating	Ampere Rating	Opening Time
100%	1/500–15	4 Hours, Min.
200%	1/500–3/10	5 Seconds, Max.
	4/10-5	2 Seconds, Max.

Electrical Characteristics

Ampere Rating (A)	Amp Code	Max Voltage Rating (V)	Interrupting Rating	Nominal Cold Resistance (Ohms)	Agency Approvals		
							
.002	.002	125	10,000 amperes at 125 VAC/VDC	2000	X	X	X
.005	.005	125		280	X	X	X
.010	.010	125		94.0	X	X	X
.015	.015	125		44.0	X	X	X
.031	.031	125		16.45	X	X	X
.050	.050	125		3.20	X	X	X
.062	.062	125		2.25	X	X	X
.100	.100	125		1.17	X	X	X
.125	.125	125		1.0	X	X	X
.200	.200	125		2.30	X	X	X
.250	.250	125		1.75	X	X	X
.300	.300	125		1.25	X	X	X
.400	.400	125		0.227	X	X	X
.500	.500	125		0.167	X	X	X
.600	.600	125		0.140	X	X	X
.700	.700	125		0.114	X	X	X
.750	.750	125		0.104	X	X	X
.800	.800	125		0.094	X	X	X
1.00	001.	125		0.100	X	X	X
01.5	01.5	125		0.063	X	X	X
2.00	002.	125		0.046	X	X	X
3.00	003.	125	0.034	X	X	X	
4.00	004.	125	0.019	X	X	X	
5.00	005.	125	0.018	X	X	X	

Please contact Littelfuse for Average Time Current Curve.

Soldering Parameters - Wave Soldering

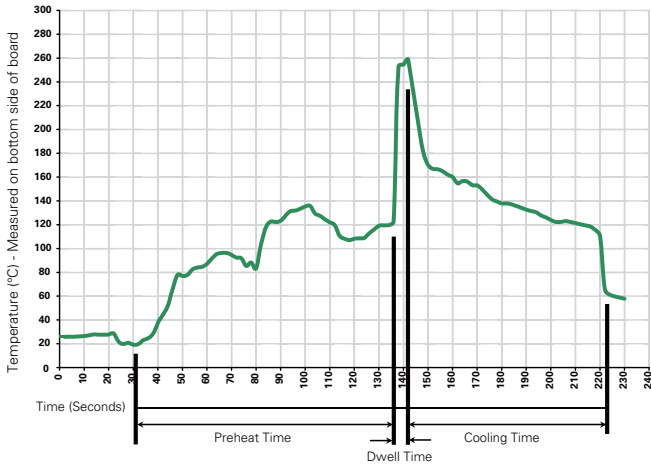

Recommended Process Parameters:

Wave Parameter	Lead-Free Recommendation
Preheat: (Depends on Flux Activation Temperature)	(Typical Industry Recommendation)
Temperature Minimum:	100° C
Temperature Maximum:	150° C
Preheat Time:	60-180 seconds
Solder Pot Temperature:	260° C Maximum
Solder Dwell Time:	2-5 seconds

Recommended Hand-Solder Parameters:

Solder Iron Temperature: 350° C +/- 5°C
Heating Time: 5 seconds max.

Note: These devices are not recommended for IR or Convection Reflow process.

Temperature Derating Curve

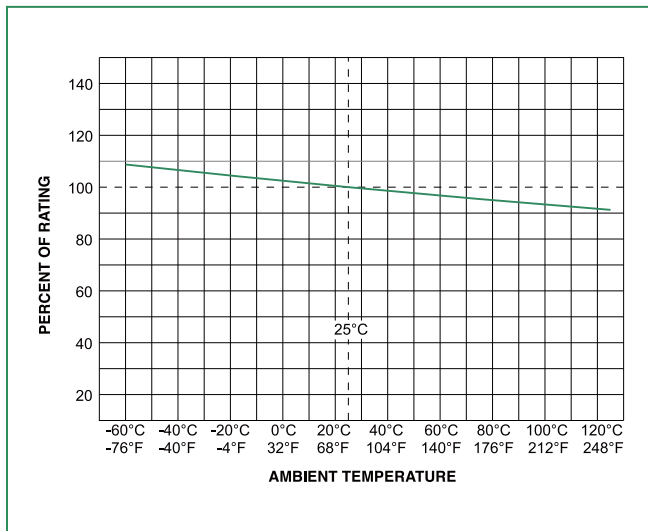

Please contact Littelfuse for average time current curve.

Product Characteristics

Materials	Gold-Plated Copper Leads, Type II (Fuse cap is also Gold-Plated)
Weight	262 and 269 Series .36 Grams; 268 Series .48 Grams
Lead Pull Force	MIL-STD-202, Method 211, Test Condition A (will withstand a 5 lb. axial pull test)
AQL (Electrical Characteristics)	Certified to 1% AQL
Sampling	Per MIL-STD-105, Inspection Level II
Traceability and Identification Records	Controlled by lot number and retained on file for a minimum of three years. Copies of Lot Certification Test data available when requested with order
Options	Special screening tests, burn-in, etc. can be supplied on special order to meet specific requirements
Product Marking	262 / 268 Series: Brand logo, current and voltage ratings 269 Series: Brand logo, current and voltage ratings and agency approval mark

Operating Temperature	-55°C to +125°C
Shock	(1/500): MIL-STD-202, Method 213, Test Condition A (50 G's peak for 11 milliseconds). (1/200-5): MIL-STD-202, Method 213, Test Condition I (100 G's peak for 6 milliseconds)
Vibration	MIL-STD-202, Method 201 (10-55 Hz); MIL-STD-202, Method 204, Test Condition C (55-2000 Hz at 10 G's Peak)
Salt Spray	MIL-STD-202, Method 101, Test Condition B
Seal Test	MIL-STD-202, Method 112, Test Condition A
Insulation Resistance (After Opening)	MIL-STD-202, Method 302, Test Condition A (1/2 Megohm minimum)
Thermal Shock	MIL-STD-202, Method 107, Test Condition B (-65°C to 125°C)
Moisture Resistance	MIL-STD-202, Method 106
Fuses to MIL SPEC	262 Series is available in FM07A on QPL for MIL-PRF-23419/7. To order, change 262 to 269

Dimensions

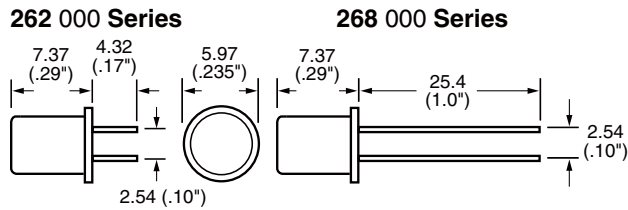

Part Numbering System

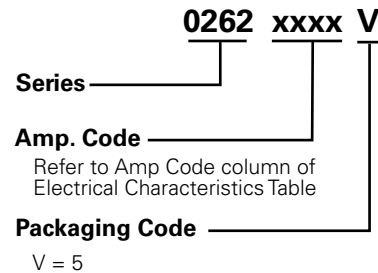

Packaging

Packaging Option	Packaging Specification	Quantity	Quantity & Packaging Code
Bulk	N / A	5	V

272/273/274/278/279 Series, MICRO™ Very Fast-Acting Fuse

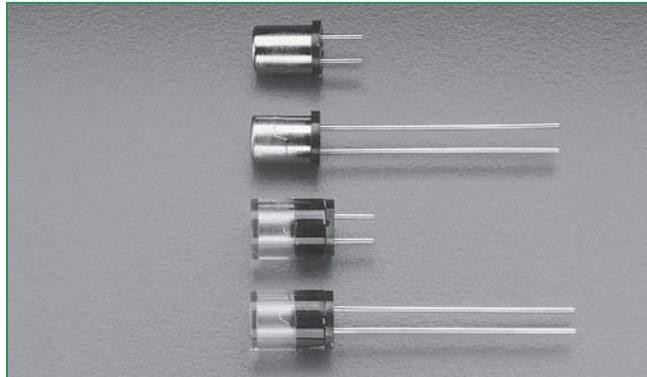

Description

Developed originally for the U.S. Space Program, MICRO™ fuse provides reliability in a compact design. The MICRO™ fuse is available in plug-in or radial lead styles and a complete range of ampere ratings from 1/500 to 5A to suit a wide variety of design needs.

Features

- Military grade available
- High breaking capacity
- Clear cover option to view fuse element status
- Available from very low ampere of 2mA to 5A
- Plug-in with short or long leads option

Applications

- Printed circuit boards and similar equipment
- Electronic components

Agency Approvals

Agency	Agency File Number	Ampere Range
	E10480	2mA - 5A
	LR 29862	2mA - 5A
	FM02	2mA - 5A

Electrical Characteristics

% of Ampere Rating	Ampere Rating	Opening Time
100%	1/500-5	4 Hours, Min.
200%	1/500-3/10	5 Seconds, Max.
	4/10-5	2 Seconds, Max.

Electrical Characteristics

Ampere Rating (A)	Amp Code (for all above series)	Max Voltage Rating (V)	Interrupting Rating	Nominal Cold Resistance (Ohms)	Nominal Melting I ² t (A ² sec)	Agency Approvals		
.002	.002	125	10,000 amperes at 125 VAC/VDC.	2200	0.00000000845	X	X	X
.005	.005	125		280	0.00000000810	X	X	X
.010	.010	125		80.0	0.000000462	X	X	X
.015	.015	125		44.0	0.00000123	X	X	X
.031	.031	125		16.0	0.00000810	X	X	X
.050	.050	125		3.20	0.0000666	X	X	X
.062	.062	125		2.32	0.000115	X	X	X
.100	.100	125		1.25	0.000385	X	X	X
.125	.125	125		1.0	0.000691	X	X	X
.200	.200	125		2.30	0.00409	X	X	X
.250	.250	125		1.75	0.00640	X	X	X
.300	.300	125		1.25	0.00945	X	X	X
.400	.400	125		0.227	0.0251	X	X	X
.500	.500	125		0.167	0.0716	X	X	X
.600	.600	125		0.430	0.0411	X	X	X
.700	.700	125		0.324	0.0710	X	X	X
.750	.750	125		0.293	0.0900	X	X	X
.800	.800	125		0.271	0.113	X	X	X
1.00	.001	125		0.0880	0.0648	X	X	X
01.5	01.5	125		0.0578	0.160	X	X	X
2.00	002.	125		0.0425	0.300	X	X	X
3.00	003.	125		0.0275	0.759	X	X	X
4.00	004.	125		0.0202	1.38	X	X	X
5.00	005.	125		0.0156	2.21	X	X	X

272-4/278-9

Temperature Derating Curve

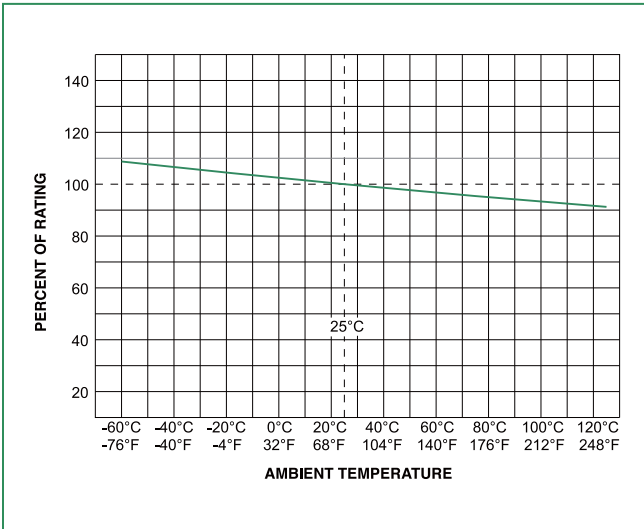

Average Time Current Curves

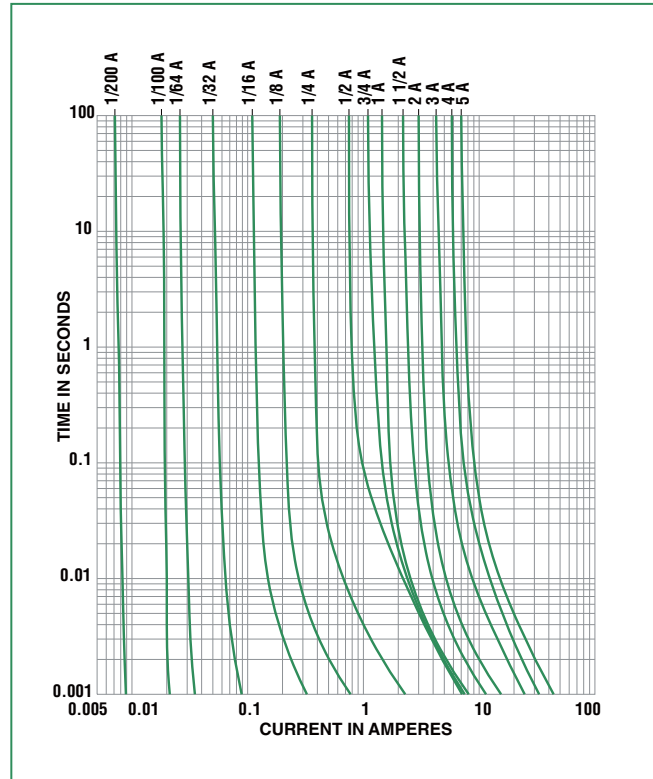

Soldering Parameters - Wave Soldering

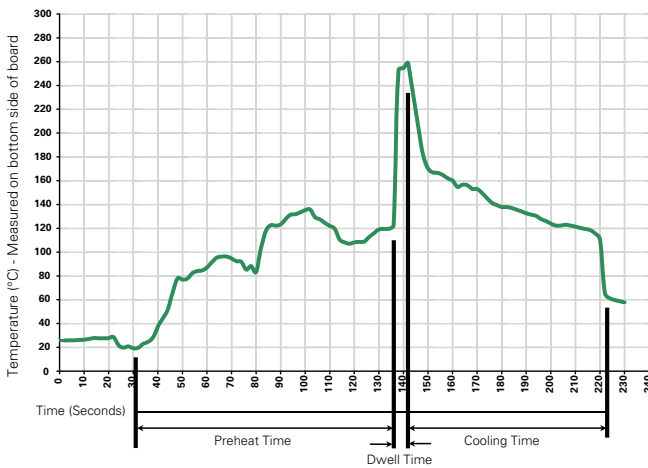

Recommended Process Parameters:

Wave Parameter	Lead-Free Recommendation
Preheat: (Depends on Flux Activation Temperature)	(Typical Industry Recommendation)
Temperature Minimum:	100° C
Temperature Maximum:	150° C
Preheat Time:	60-180 seconds
Solder Pot Temperature:	260° C Maximum
Solder Dwell Time:	2-5 seconds

Recommended Hand-Solder Parameters:

Solder Iron Temperature: 350° C +/- 5°C
 Heating Time: 5 seconds max.

Note: These devices are not recommended for IR or Convection Reflow process.

Product Characteristics

Operating Temperature:	273 and 279: -55°C to +85°C; 272 and 278: -55°C to +125°C
Fuses to MIL SPEC	273 Series is available in CSA LR 29862. Military QPL type (FM02). To order, change 273 to 274.
Materials	272 and 278 series cap: Nickel Plated Brass 273, 274 and 279 series cap: Mirror polished Polycarbonate Base: R-4 Ryton Pins: Tin Plated Copper
Product Marking	Current and voltage ratings stamped on cap

Part Numbering System

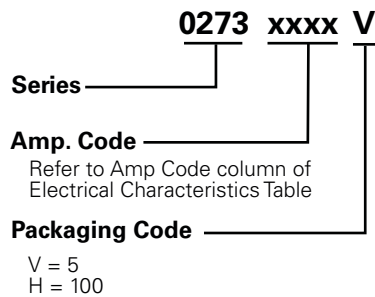

Dimensions

272 000 Series (Short Lead, Metal Cap)

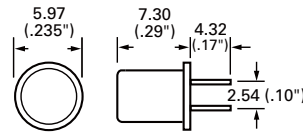

278 000 Series (Long Lead, Metal Cap)

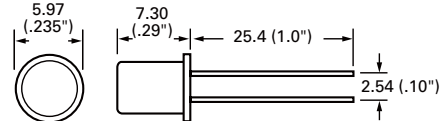

273 000 and 274 000 Series (Short Lead, Clear Plastic Cap)

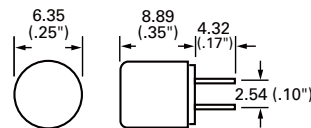

279 000 Series (Long Lead, Clear Plastic Cap)

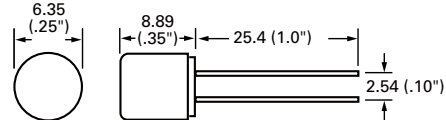

NOTE: Amperage and voltage rating stamped on cap.
Leads are tin plated copper; .025" diameter.

Packaging

Packaging Option	Packaging Specification	Quantity	Quantity & Packaging Code
Bulk	N / A	5	V
Bulk	N / A	100	H

RoHS **Pb** **303 Series, TR3®, Fast-Acting Fuse**

Description

The 303 Series are TR3®, fast-acting type, 125V rated fuses designed in accordance to UL 248-14.

Features

- Reduced PCB space requirements
- Direct solderable or plug-in versions
- Internationally approved
- Low internal resistance
- Shock safe casing
- Vibration resistant
- Halogen free
- Lead-free
- Available from 50mA to 5A

Agency Approvals

Agency	Agency File Number	Ampere Range
	E67006	50mA-5A
	051378	50mA-5A

Electrical Characteristics

% of Ampere Rating	Opening Time
200	60 Seconds, Maximum

Applications

- Battery chargers
- Consumer electronics
- Power supplies
- Industrial controllers

Electrical Characteristics

Amp Code	Rated Current	Voltage Rating	Breaking Capacity	Voltage Drop 1.0 x I _N max. (mV)	Power Dissipation 1.0 x I _N max. (mW)	Melting Integral 10 x I _N max. (A ² s)	Approvals	
0050	50mA	125V	50A / 125VAC 60-60 Hz/cos φ - 1 50A / 63 VDC	800	40	0.00007	X	X
0063	63mA	125V		780	50	0.00013	X	X
0080	80mA	125V		730	60	0.0002	X	X
0100	100mA	125V		700	70	0.0004	X	X
0125	125mA	125V		650	85	0.0022	X	X
0160	160mA	125V		600	100	0.0029	X	X
0200	200mA	125V		550	110	0.0042	X	X
0250	250mA	125V		500	125	0.0082	X	X
0315	315mA	125V		450	145	0.015	X	X
0400	400mA	125V		400	160	0.025	X	X
0500	500mA	125V		380	190	0.042	X	X
0630	630mA	125V		160	100	0.015	X	X
0800	800mA	125V		155	125	0.025	X	X
1100	1.00A	125V		150	155	0.039	X	X
1125	1.25A	125V		145	185	0.059	X	X
1160	1.60A	125V		140	225	0.11	X	X
1200	2.00A	125V		130	260	0.17	X	X
1250	2.50A	125V		125	315	0.23	X	X
1315	3.15A	125V		120	380	0.45	X	X
1400	4.00A	125V		110	440	1.0	X	X
1500	5.00A	125V	105	525	1.5	X	X	

Note: 1.00 means the number one with two decimal places. 1,000 means the number one thousand.

Temperature Derating Curve

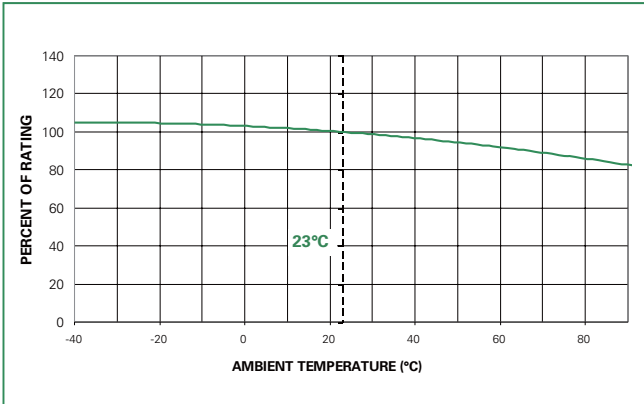

Average Time Current Curves

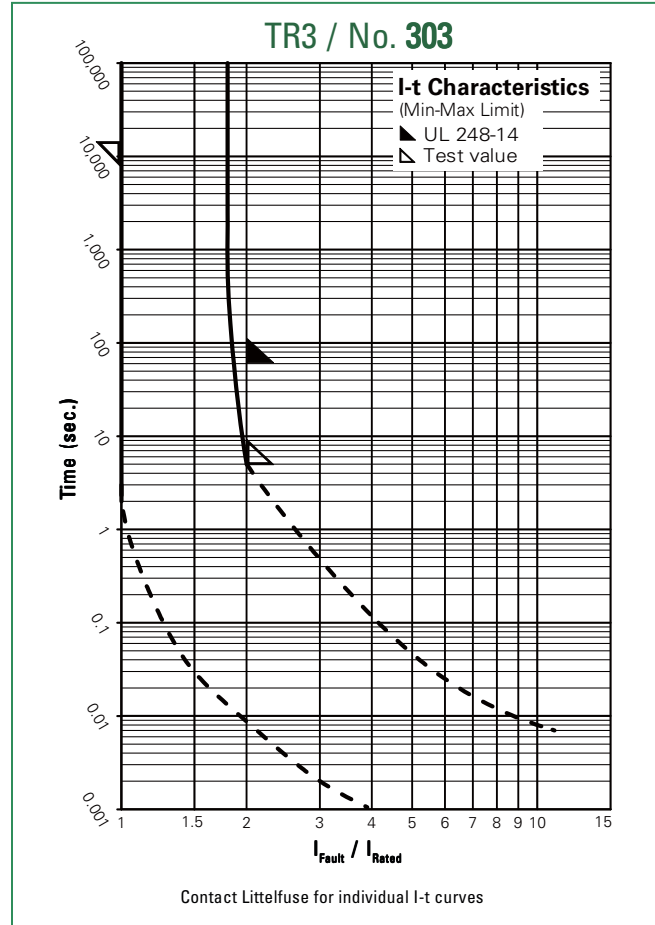

Soldering Parameters - Wave Soldering

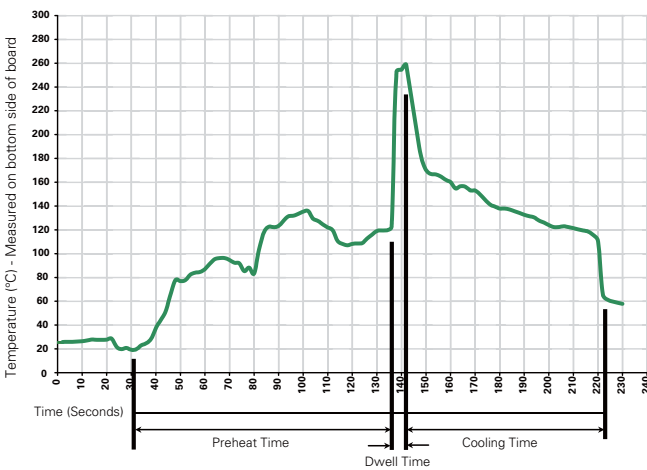

Recommended Process Parameters:

Wave Parameter	Lead-Free Recommendation
Preheat: (Depends on Flux Activation Temperature)	(Typical Industry Recommendation)
Temperature Minimum:	100° C
Temperature Maximum:	150° C
Preheat Time:	60-180 seconds
Solder Pot Temperature:	260° C Maximum
Solder Dwell Time:	2-5 seconds

Recommended Hand-Solder Parameters:

Solder Iron Temperature: 350° C +/- 5°C
Heating Time: 5 seconds max.

Note: These devices are not recommended for IR or Convection Reflow process.

Product Characteristics

Materials	Base/Cap: Black Thermoplastic Base Polyamide PA 6.6, UL 94V-0 Brass, Nickel-plated Cap Round Pins: Copper alloy, Tin-plated
Lead Pull Strength	10 N (EN 60068-2-21)
Solderability	260°C, ≤ 3s. (Wave) 350°C, ≤ 1s. (Soldering Iron)
Soldering Heat Resistance	260°C, 10s. (IEC 60068-2-20) 350°C, 3s. (Soldering Iron)

Operating Temperature	-25°C to +70°C (consider de-rating)
Climatic Category	-25°C/+70°C/21 days (EN 60068-1.3)
Stock Conditions	+10°C to +60°C RH, ≤ 75% yearly average, without dew
Vibration Resistance	24 cycles at 15 min. each (EN 60068-6) 10 - 60 Hz at 0.75 mm amplitude 60 - 2000 Hz at 10 g acceleration

Dimensions

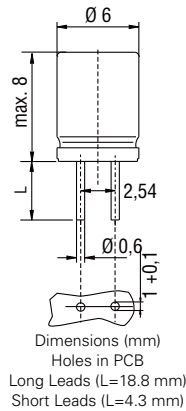

Part Numbering System

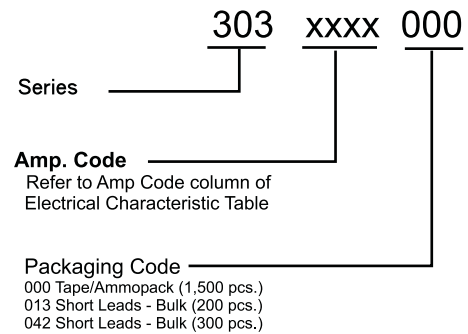

Packaging

Packaging Option	Packaging Specification	Quantity	Quantity & Packaging Code	Reel Size
303 Series				
Tape & Ampopack	N/A	1,500	000	N/A
Short Leads	N/A	200	013	N/A
Short Leads	N/A	300	042	N/A

RoHS  **370 Series, TR5®, Fast-Acting Fuse**









Description

The 370 Series are TR5®, sub-miniature, fast-acting type, 250V rated fuses, designed in accordance to IEC 60127-3.

Features

- Reduced PCB space requirements
- Direct solderable or plug-in versions
- Internationally approved
- Low internal resistance
- Shock safe casing
- Vibration resistant
- Halogen free
- Lead-free
- Available from 40mA to 6.3A

Agency Approvals

Agency	Agency File Number	Ampere Range
	License number: 5007679-1170-0001/82438	100mA - 5A
	License number: 5007679-1170-0001/97059 5007679-1170-0009/97069 5007679-1170-0002/82443	40mA 50mA - 80mA 6.3A
	Certificate number: 710055	50mA - 6.3A
	File number: E67006	40mA - 6.3A
	JET0381-31007-2003	1A - 5A
	2007010207240347	50mA - 5A





Applications

- Battery Chargers
- Consumer Electronics
- Power supplies
- Industrial Controllers

Electrical Characteristics

% of Ampere Rating	Opening Time
150%	1 Hour, Min.
210%	30 Minutes, Max.
275%	10 ms, Min. ; 3 Sec., Max.
400%	3 ms, Min. ; 300 ms, Max.
1000%	20 ms, Max.

Electrical Characteristics

Amp Code	Rated Current	Voltage Rating	Breaking Capacity	Voltage Drop $1.0 \times I_N$ max. (mV)	Power Dissipation $1.5 \times I_N$ max. (mW)	Melting Integral $10 \times I_N$ max. (A ² s)	Agency Approvals				
											
0040	40mA	250V	35 A / 250VAC ¹ 50-60 Hz cos φ = 1.0	900	100	0.0002	G		X		
0050	50mA	250V		320	80	0.00035	X	X	X		X
0063	63mA	250V		350	100	0.0005	X	X	X		X
0080	80mA	250V		370	120	0.0014	X	X	X		X
0100	100mA	250V		600	130	0.0038	X	X	X		X
0125	125mA	250V		550	172	0.0066	X	X	X		X
0160	160mA	250V		500	165	0.014	X	X	X		X
0200	200mA	250V		465	190	0.03	X	X	X		X
0250	250mA	250V		400	250	0.051	X	X	X		X
0315	315mA	250V		380	250	0.1	X	X	X		X
0400	400mA	250V		120	135	0.025	X	X	X		X
0500	500mA	250V		120	155	0.042	X	X	X		X
0630	630mA	250V		115	200	0.076	X	X	X		X
0800	800mA	250V		120	310	0.12	X	X	X		X
1100	1.00A	250V		110	310	0.2	X	X	X	X	X
1125	1.25A	250V		100	360	0.31	X	X	X	X	X
1160	1.60A	250V		100	600	0.53	X	X	X	X	X
1200	2.00A	250V		85	500	0.98	X	X	X	X	X
1250	2.50A	250V		80	660	1.8	X	X	X	X	X
1315	3.15A	250V		90	950	3.1	X	X	X	X	X
1400	4.00A	250V	40 A / 250 VAC	80	920	6.7	X	X	X	X	
1500	5.00A	250V	50 A / 250 VAC	80	1000	12.00	X	X	X	X	
1630	6.30A*	250V		70	1200	24.00	G	X	X		

¹ Per UL, approved breaking capacity is 50 A at 250 V.

* Conducting path min. 0.2 mm²

G = Expert Report pending

Note: 1.00 means the number one with two decimal places. 1,000 means the number one thousand.

Temperature Derating Curve

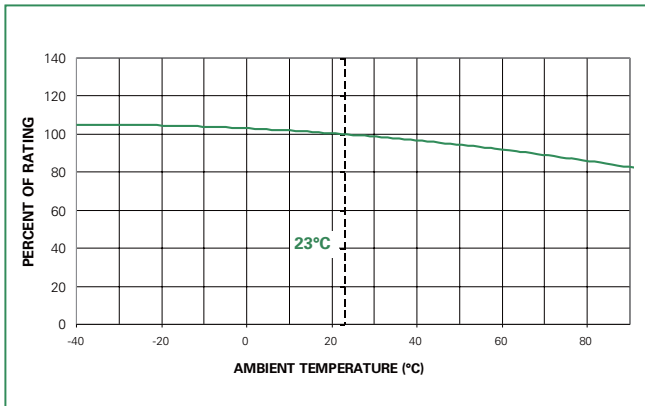

Average Time Current Curves

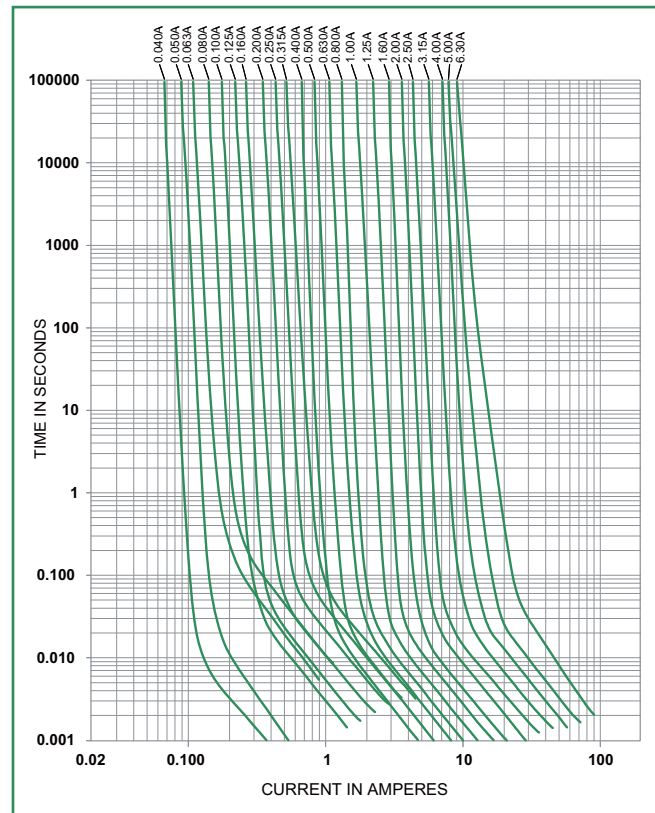

Soldering Parameters - Wave Soldering

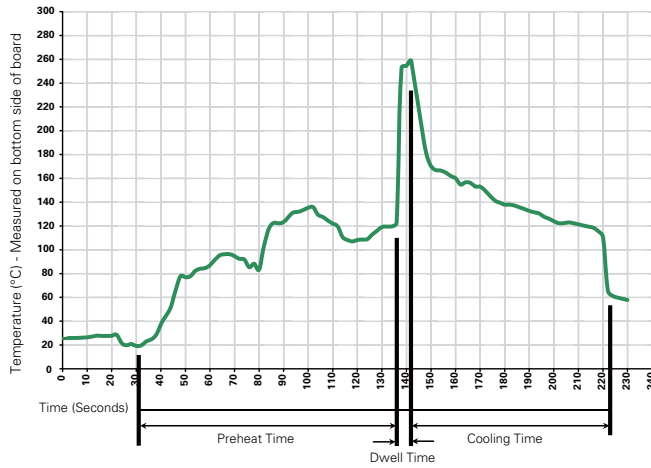

Recommended Process Parameters:

Wave Parameter	Lead-Free Recommendation
Preheat: (Depends on Flux Activation Temperature)	(Typical Industry Recommendation)
Temperature Minimum:	100°C
Temperature Maximum:	150°C
Preheat Time:	60-180 Seconds
Solder Pot Temperature:	260°C Maximum
Solder Dwell Time:	2-5 Seconds

Recommended Hand-Solder Parameters:

Solder Iron Temperature: 350° C +/- 5°C
 Heating Time: 5 seconds max.

Note: These devices are not recommended for IR or Convection Reflow process.

Product Characteristics

Materials	Base/Cap: Brown Thermoplastic Polyamide PA 6,6, UL 94 V-0 Round Pins: Copper, Tin-plated
Lead Pull Strength	10 N (EN 60068-2-21)
Solderability	260°C, ≤ 3s. (Wave) 350°C, ≤ 1s. (Soldering Iron)
Soldering Heat Resistance	260°C, 10s. (IEC 60068-2-20) 350°C, 3s. (Soldering Iron)

Operating Temperature	-40°C to +85°C (consider de-rating)
Climatic Category	-40°C to +85°C/21 days (IEC 60068-1,-2-1,-2-2,-2-78)
Stock Conditions	+10°C to +60°C RH ≤ 75% yearly average, without dew, maximum value for 30 days-95%
Vibration Resistance	24 cycles at 15 min. each (EN 60068-2-6) 10 - 60 Hz at 0.75 mm amplitude 60 - 2000 Hz at 10G acceleration

Dimensions

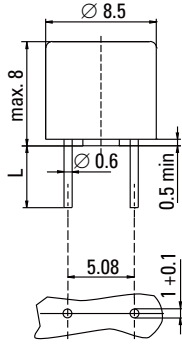

Holes in PCB
Long Leads (L=18.8mm)
Short Leads (L=4.3mm)

Part Numbering System

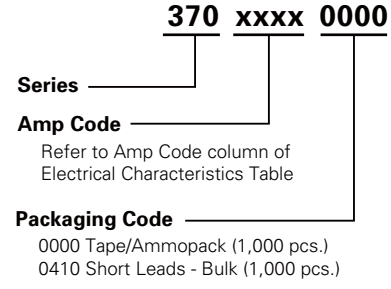

Packaging

Packaging Option	Packaging Specification	Quantity	Quantity & Packaging Code	Taping Width
370 Series				
Tape & Ammopack	N/A	1,000	0000	N/A
Short Leads	N/A	1,000	0410	N/A

RoHS **Pb** **372 Series, TR5®, Time-Lag Fuse**

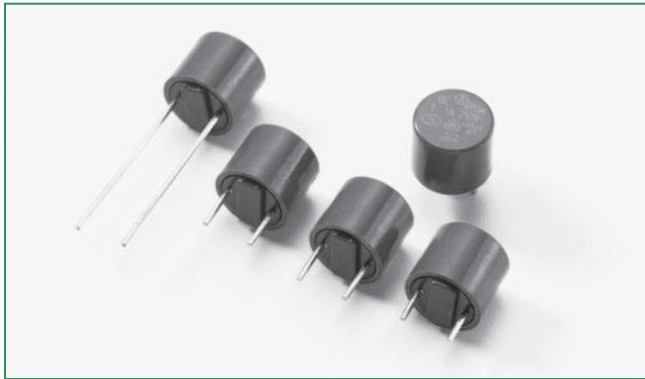

Description

The 372 Series are TR5®, time-Lag type, 250V rated fuses, that are designed in accordance to IEC 60127-3.

Features

- Lead-free
- Reduced PCB space requirements
- Direct solderable or plug-in versions
- Internationally approved
- Low internal resistance
- Shock safe casing
- Vibration resistant
- Halogen free
- Available from 40mA to 6.3A

Agency Approvals

Agency	Agency File Number	Ampere Range
	5007679-1170-0003/82447	50mA - 4A
	5007679-1170-0004/82452	5A - 6.3A
	JET1896-31007-2002	1A - 5A
	709066	50mA - 6.3A
	E67006	40mA - 6.3A
	SU05024-7010 SU05024-7011 SU05024-7006 SU05024-7007 SU05024-7008 SU05024-7009 SU05024-7012	50mA - 100mA 125mA - 800mA 1A - 2.5A 3.15A 4A 5A 6.3A
	CQC07012021162	5A - 6.3A
	2007010207240346	40mA - 4A

Applications







- Battery Chargers
- Consumer electronics
- Power supplies
- Industrial Controllers

Electrical Characteristics

% of Ampere Rating	Opening Time
150%	1 Hour, Min.
210%	2 Minutes, Max.
275%	400 ms, Min. ; 10 Sec., Max.
400%	150 ms, Min. ; 3 Sec., Max.
1000%	20 ms, Min. ; 150 ms, Max.

372 Series

Electrical Characteristics

Amp Code	Rated Current	Voltage Rating	Breaking Capacity	Voltage Drop 1.0 x I _N max. (mV)	Power Dissipation 1.5 x I _N max. (mW)	Melting Integral 10 x I _N min. (A ² s)	Agency Approvals						
													
0040	40mA	250V	35A/250VAC ¹ 50-60 Hz cos φ = 1.0	900	90	0.009			X				
0050	50mA	250V		500	70	0.01	X	X	X		X	X	
0063	63mA	250V		400	80	0.02	X	X	X		X	X	
0080	80mA	250V		370	100	0.023	X	X	X		X	X	
0100	100mA	250V		300	110	0.047	X	X	X		X	X	
0125	125mA	250V		260	120	0.066	X	X	X		X	X	
0160	160mA	250V		200	130	0.14	X	X	X		X	X	
0200	200mA	250V		170	140	0.20	X	X	X		X	X	
0250	250mA	250V		150	150	0.28	X	X	X		X	X	
0315	315mA	250V		140	160	0.36	X	X	X		X	X	
0400	400mA	250V		130	170	0.9	X	X	X		X	X	
0500	500mA	250V		125	180	1.3	X	X	X		X	X	
0630	630mA	250V		120	200	2.5	X	X	X		X	X	
0800	800mA	250V		110	220	3.8	X	X	X		X	X	
1100	1.00A	250V		110	360	5.5	X	X	X	X	X	X	
1125	1.25A	250V		95	450	9	X	X	X	X	X	X	
1160	1.60A	250V		95	450	14	X	X	X	X	X	X	
1200	2.00A	250V		85	600	23	X	X	X	X	X	X	
1250	2.50A	250V		80	700	35	X	X	X	X	X	X	
1315	3.15A	250V		80	1100	60	X	X	X	X	X	X	
1400	4.00A	250V	40A / 250 VAC	75	1200	95	X	X	X	X	X		
1500	5.00A	250V	50A / 250 VAC	80	1300	94	G	X	X	X	CQC	X	
1630	6.30A*	250V		58	1250	105	G	X	X	X	CQC	X	

1 Per UL, approved breaking capacity is 50 A at 250 V.

* Conducting path min. 0.2 mm²

G = Expert Report

Note: 1.00 means the number one with two decimal places. 1,000 means the number one thousand.

Temperature Derating Curve

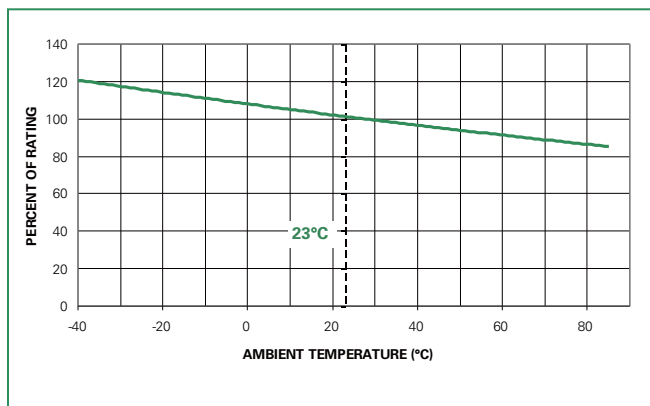

Average Time Current Curves

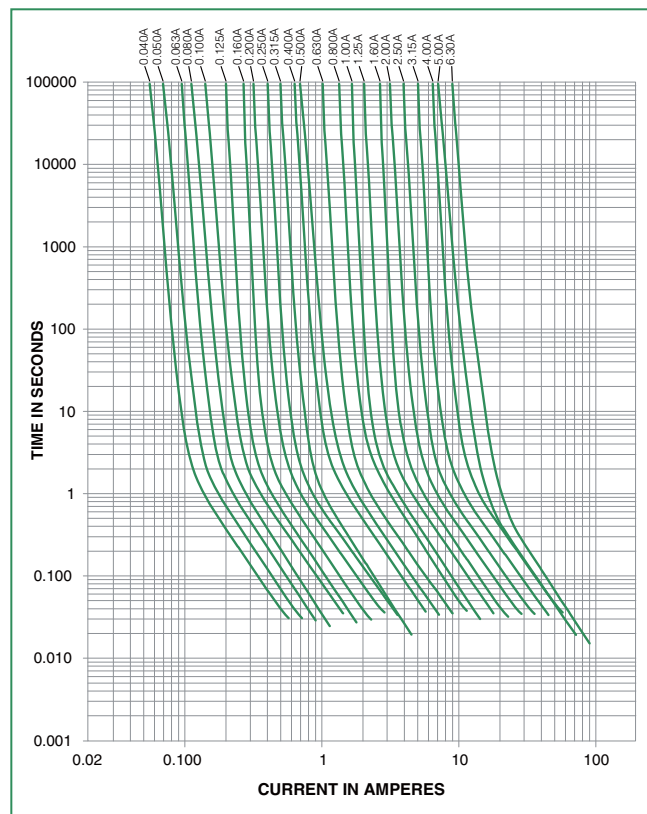

Soldering Parameters - Wave Soldering

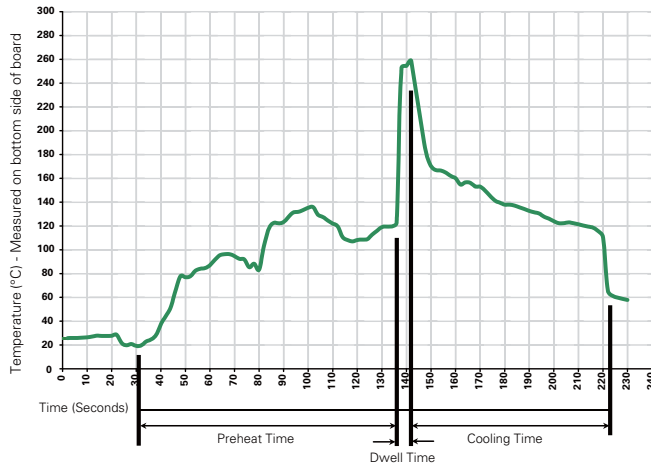

Recommended Process Parameters:

Wave Parameter	Lead-Free Recommendation
Preheat: (Depends on Flux Activation Temperature)	(Typical Industry Recommendation)
Temperature Minimum:	100° C
Temperature Maximum:	150° C
Preheat Time:	60-180 seconds
Solder Pot Temperature:	260° C Maximum
Solder Dwell Time:	2-5 seconds

Recommended Hand-Solder Parameters:

Solder Iron Temperature: 350° C +/- 5° C
 Heating Time: 5 seconds max.

Note: These devices are not recommended for IR or Convection Reflow process.

Product Characteristics

Materials	Base/Cap: Brown Thermoplastic Polyamide PA 6.6, UL 94 V-0 Round Pins: Copper, Tin-plated
Lead Pull Strength	10 N (EN 60068-2-21)
Solderability	260°C, ≤ 3s. (Wave) 350°C, ≤ 1s. (Soldering Iron)
Soldering Heat Resistance	260°C, 10s. (IEC 60068-2-20) 350°C, 3s. (Soldering Iron)

Operating Temperature	-40°C to +85°C (consider de-rating)
Climatic Category	-40°C/+85°C/21 days (IEC 60068-1,-2-1,-2-2,-2-78)
Stock Conditions	+10°C to +60°C RH ≤ 75% yearly average, without dew, maximum value for 30 days-95%
Vibration Resistance	24 cycles at 15 min. each (EN 60068-2-6) 10 - 60 Hz at 0.75 mm amplitude 60 - 2000 Hz at 10G's acceleration

Dimensions

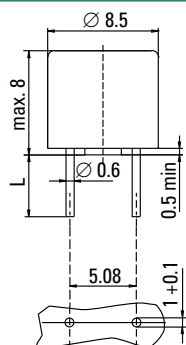

Long Leads (L=18.8mm)
Short Leads (L=4.3mm)

Part Numbering System

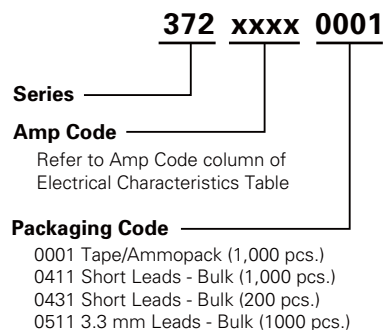

Packaging

Packaging Option	Packaging Specification	Quantity	Quantity & Packaging Code	Taping Width
372 Series				
Tape & Ammopack	N/A	1,000	0001	N/A
Short Leads	N/A	1,000	0411	N/A
Short Leads	N/A	200	0431	N/A
3.3mm Leads	N/A	1,000	0511	N/A

RoHS  **373 Series, TR5®, Fast-Acting Fuse**



Description

The TR5® 373 Series are fast-acting 250V rated fuses, that are designed in accordance to UL 248-14.



Features

- Reduced PCB space requirements
- Direct solderable or plug-in versions
- Internationally approved
- Low internal resistance
- Shock safe casing
- Vibration resistant
- Halogen free
- Lead-free
- Available from 50mA to 10A

Applications

- Battery Chargers
- Consumer Electronics
- Power supplies
- Industrial Controllers



Agency Approvals

Agency	Agency File Number	Ampere Range
	File number: E 67006	50mA - 6.3A
	Certification: 51378	50mA - 6.3A
	File number: E67006	8A - 10A

Electrical Characteristics

% of Ampere Rating	Ampere Rating	Opening Time
200%	50mA - 6.3A	5 Seconds, Max.
	8A - 10A	60 Seconds, Max.

Electrical Characteristics

Amp Code	Rated Current	Voltage Rating	Breaking Capacity	Voltage Drop $1.0 \times I_N$ max. (mV)	Power Dissipation $1.0 \times I_N$ max. (mW)	Melting Integral $10 \times I_N$ max. (A ² s)	Agency Approvals		
									
0050	50mA	250V	50A / 250 VAC 50-60 Hz cos φ = 1.0	1400	70	0.0001	X	X	
0063	63mA	250V		1300	85	0.00023	X	X	
0080	80mA	250V		1200	100	0.00037	X	X	
0100	100mA	250V		1100	110	0.0013	X	X	
0125	125mA	250V		1000	125	0.0019	X	X	
0160	160mA	250V		950	155	0.004	X	X	
0200	200mA	250V		850	170	0.0065	X	X	
0250	250mA	250V		750	190	0.014	X	X	
0315	315mA	250V		650	205	0.032	X	X	
0400	400mA	250V		230	95	0.016	X	X	
0500	500mA	250V		220	110	0.025	X	X	
0630	630mA	250V		210	135	0.045	X	X	
0800	800mA	250V		200	160	0.069	X	X	
1100	1.00A	250V		190	190	0.125	X	X	
1125	1.25A	250V		180	225	0.2	X	X	
1160	1.60A	250V		170	275	0.38	X	X	
1200	2.00A	250V		160	320	0.63	X	X	
1250	2.50A	250V		150	375	1.2	X	X	
1315	3.15A	250V		140	445	1.9	X	X	
1400	4.00A	250V		130	520	3.5	X	X	
1500	5.00A	250V		120	630	6.2	X	X	
1630	6.30A	250V	115	1000	9.1	X	X		
1800	8.00A ¹	250V	120	1600	30			X	
2100	10.00A ¹	250V	110	2000	55			X	

1. Conducting path cross-section minimum $\geq 0.2\text{mm}^2$
 Note: 1.00 means the number one with two decimal places. 1,000 means the number one thousand.

Temperature Derating Curve

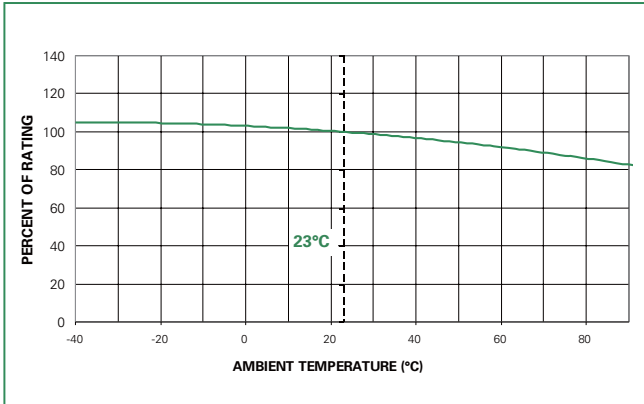

Average Time Current Curves

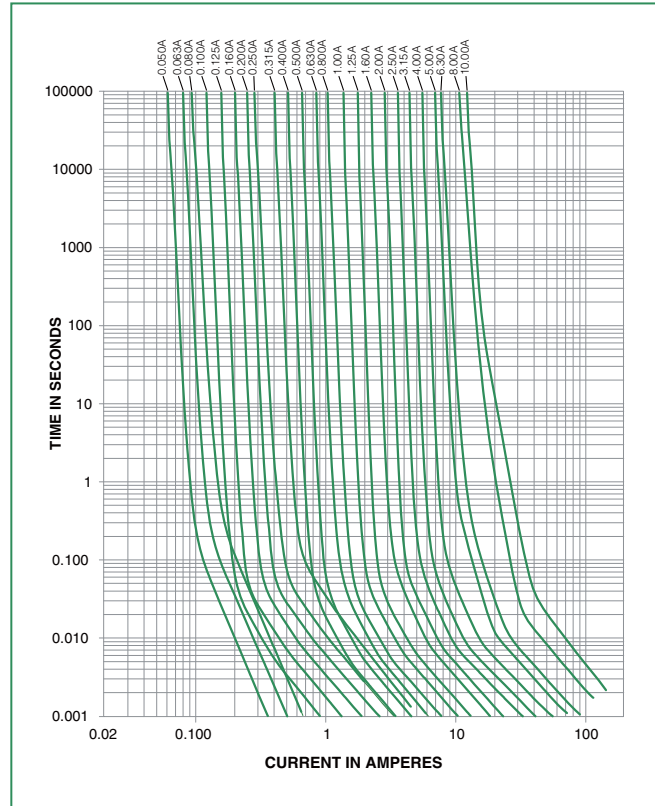

Soldering Parameters - Wave Soldering

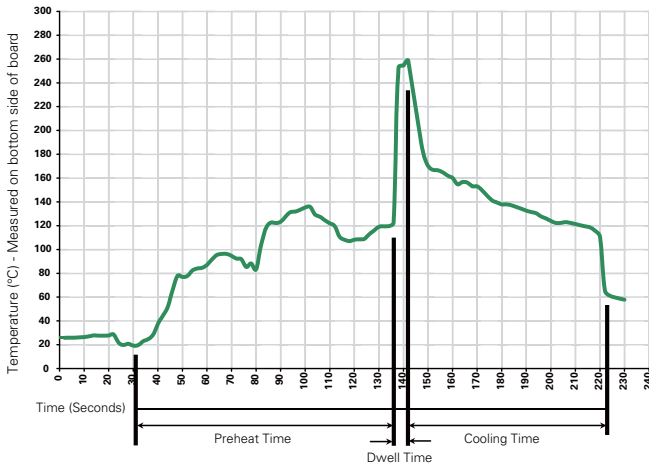

Recommended Process Parameters:

Wave Parameter	Lead-Free Recommendation
Preheat: (Depends on Flux Activation Temperature)	(Typical Industry Recommendation)
Temperature Minimum:	100° C
Temperature Maximum:	150° C
Preheat Time:	60-180 seconds
Solder Pot Temperature:	260° C Maximum
Solder Dwell Time:	2-5 seconds

Recommended Hand-Solder Parameters:

Solder Iron Temperature: 350° C +/- 5° C
Heating Time: 5 seconds max.

Note: These devices are not recommended for IR or Convection Reflow process.

Product Characteristics

Materials	Base/Cap: Brown Thermoplastic Polyamide PA 6.6, UL 94 V-0 Round Pins: Copper, Tin-plated
Lead Pull Strength	10 N (EN 60068-2-21)
Solderability	260°C, ≤ 3s. (Wave) 350°C, ≤ 1s. (Soldering Iron)
Soldering Heat Resistance	260°C, 10s. (IEC 60068-2-20) 350°C, 3s. (Soldering Iron)

Operating Temperature	-40°C to +85°C (consider de-rating)
Climatic Category	-40°C/+85°C/21 days (EN 60068-1,-2-1,-2-2,-2-78)
Stock Conditions	+10°C to +60°C RH ≤ 75% yearly average, without dew, maximum value for 30 days-95%
Vibration Resistance	24 cycles at 15 min. each (EN 60068-2-6) 10 - 60 Hz at 0.75 mm amplitude 60 - 2000 Hz at 10G's acceleration

Dimensions

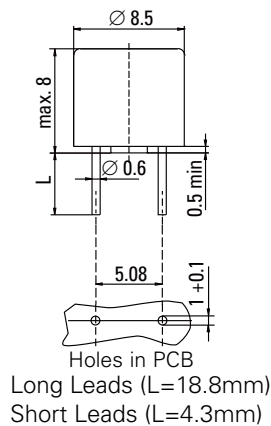

Part Numbering System

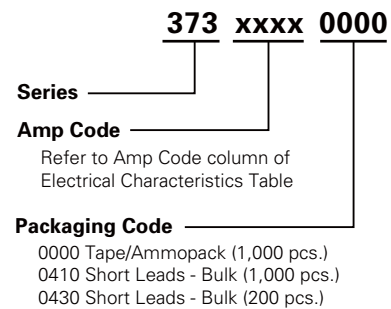

Packaging

Packaging Option	Packaging Specification	Quantity	Quantity & Packaging Code	Taping Width
373 Series				
Tape & Ammopack	N/A	1,000	0000	N/A
Short Leads	N/A	1,000	0410	N/A
Short Leads	N/A	200	0430	N/A

RoHS **Pb** **374 Series, TR5®, Time-Lag Fuse**

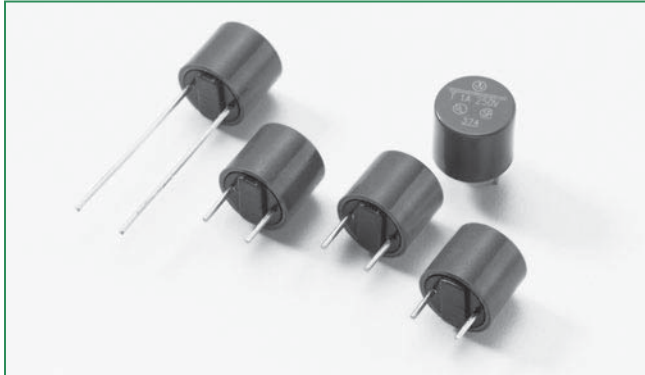

Description

The TR5® 374 Series are time-Lag 250V rated fuses, that are designed in accordance to UL 248-14.

Features

- Lead-free
- Reduced PCB space requirements
- Direct solderable or plug-in versions
- Internationally approved
- Low internal resistance
- Shock safe casing
- Vibration resistant
- Halogen free
- Available from 50mA to 10A

Agency Approvals

Agency	Agency File Number	Ampere Range
	File number: E 67006	50mA - 6.3A
	Certification: 51378	50mA - 6.3A
	File number: E 67006	8A - 10A

Applications

- Battery Chargers
- Consumer Electronics
- Power supplies
- Industrial Controllers

Electrical Characteristics

% of Ampere Rating	Opening Time
200%	60 Seconds, Max.

374 Series

Electrical Characteristics

Amp Code	Rated Current	Voltage Rating	Breaking Capacity	Voltage Drop $1.0 \times I_N$ max. (mV)	Power Dissipation $1.0 \times I_N$ max. (mW)	Melting Integral $10 \times I_N$ min. (A ² s)	Agency Approvals		
							UL®	SA®	cULus
0050	50mA	250V	50 A / 250 VAC 50-60 Hz cos φ = 1.0	900	45	0.0056	x	x	
0063	63mA	250V		800	50	0.009	x	x	
0080	80mA	250V		700	55	0.014	x	x	
0100	100mA	250V		600	60	0.025	x	x	
0125	125mA	250V		550	70	0.044	x	x	
0160	160mA	250V		480	80	0.058	x	x	
0200	200mA	250V		390	80	0.1	x	x	
0250	250mA	250V		350	90	0.17	x	x	
0315	315mA	250V		300	95	0.26	x	x	
0400	400mA	250V		250	100	0.32	x	x	
0500	500mA	250V		220	110	0.6	x	x	
0630	630mA	250V		210	135	0.75	x	x	
0800	800mA	250V		160	130	0.98	x	x	
1100	1.00A	250V		155	155	2.1	x	x	
1125	1.25A	250V		145	185	3.2	x	x	
1160	1.60A	250V		130	210	4.5	x	x	
1200	2.00A	250V		125	250	7.5	x	x	
1250	2.50A	250V		120	300	14	x	x	
1315	3.15A	250V		110	350	22	x	x	
1400	4.00A	250V		100	400	36	x	x	
1500	5.00A	250V		95	475	59	x	x	
1630	6.30A	250V	90	570	110	x	x		
1800	8.00A ¹	250V	80	1000	150			x	
2100	10.00A ¹	250V	90	1250	280			x	

Note: 1.00 means the number one with two decimal places. 1,000 means the number one thousand.

Temperature De-Rating Curve

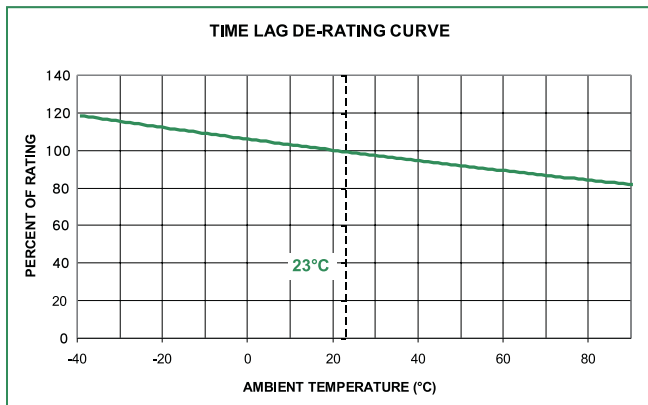

Average Time Current Curves

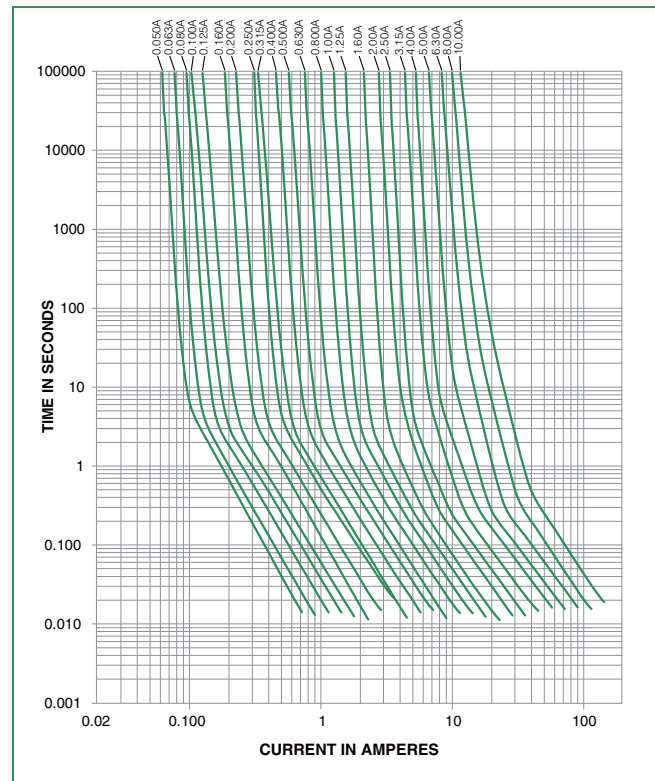

Soldering Parameters - Wave Soldering

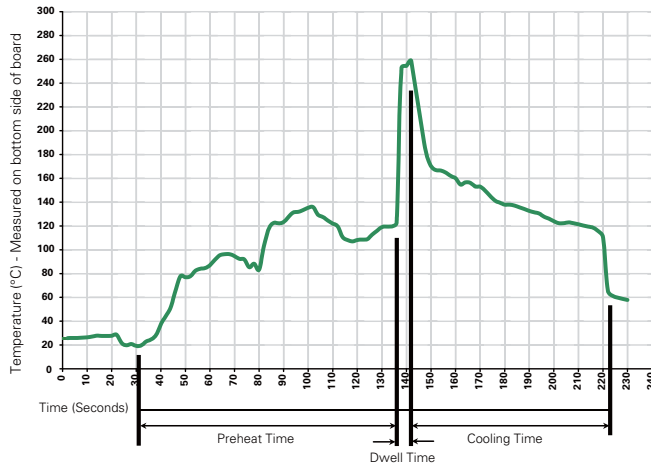

Recommended Process Parameters:

Wave Parameter	Lead-Free Recommendation
Preheat: (Depends on Flux Activation Temperature)	(Typical Industry Recommendation)
Temperature Minimum:	100° C
Temperature Maximum:	150° C
Preheat Time:	60-180 seconds
Solder Pot Temperature:	260° C Maximum
Solder Dwell Time:	2-5 seconds

Recommended Hand-Solder Parameters:

Solder Iron Temperature: 350° C +/- 5° C
 Heating Time: 5 seconds max.

Note: These devices are not recommended for IR or Convection Reflow process.

Product Characteristics

Materials	Base/Cap: Brown Thermoplastic Polyamide PA 6.6, UL 94 V-0 Round Pins: Copper, Tin-plated
Lead Pull Strength	10 N (EN 60068-2-21)
Solderability	260°C, ≤ 3s. (Wave) 350°C, ≤ 1s. (Soldering Iron)
Soldering Heat Resistance	260°C, 10s. (IEC 60068-2-20) 350°C, 3s. (Soldering Iron)

Operating Temperature	-40°C to +85°C (consider de-rating)
Climatic Category	-40°C/+85°C/21 days (EN 60068-1,-2-1,-2-2,-2-78)
Stock Conditions	+10°C to +60°C RH ≤ 75% yearly average, without dew, maximum value for 30 days-95%
Vibration Resistance	24 cycles at 15 min. each (EN 60068-2-6) 10 - 60 Hz at 0.75 mm amplitude 60 - 2000 Hz at 10G's acceleration

Dimensions

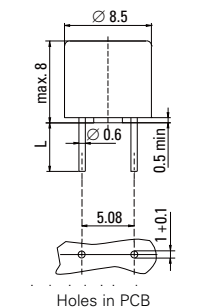

Long Leads (L=18.8mm)
 Short Leads (L=4.3mm)

Part Numbering System

374	xxxx	0000
Series		
Amp Code		
	Refer to Amp Code column of Electrical Characteristics Table	
Packaging Code		
	0000 Tape/Ammopack (1,000 pcs.) 0410 Short Leads - Bulk (1,000 pcs.) 0430 Short Leads - Bulk (200 pcs.)	

Packaging

Packaging Option	Packaging Specification	Quantity	Quantity & Packaging Code	Taping Width
374 Series				
Tape & Ammopack	N/A	1,000	0000	N/A
Short Leads	N/A	1,000	0410	N/A
Short Leads	N/A	200	0430	N/A

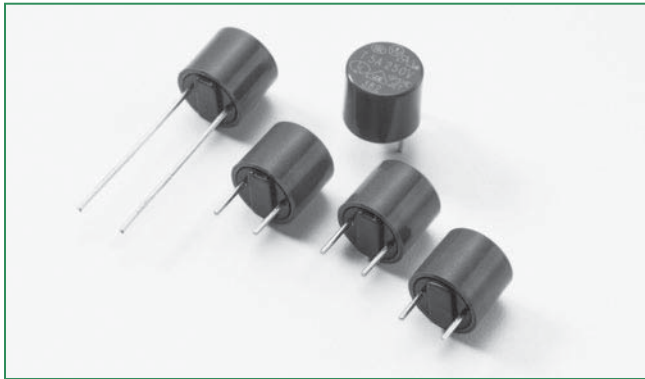
RoHS **Pb** **382 Series, TR5®, Time-Lag Fuse**

Description

The 382 Series are TR5®, time-Lag type, 250V rated fuses, with enhanced breaking capacity designed in accordance to IEC 60127-3.









Features

- Lead-free
- Reduced PCB space requirements
- Direct solderable or plug-in versions
- 100A breaking capacity
- Internationally approved
- Low internal resistance
- Shock safe casing
- Vibration resistant
- Halogen free
- Available from 1A to 10A

Applications

- Battery Chargers
- Consumer Electronics
- Power supplies
- Industrial Controllers







Agency Approvals

Agency	Agency File Number	Ampere Range
	5007679-1170-0038/82455	1A - 4A
	License number: 5007679-1170-0006/82571	5A - 6.3A
	Certification: 709068	1A - 6.3A
	File number: E 67006	1A - 10A
	JET1896-31007-2001 JET1896-31007-1003	1A - 10A
	2007010207240344	1A - 4A
	CQC07012021162	5A - 6.3A
	SU05024-7003 SU05024-7002 SU05024-7001 SU05024-7004 SU05024-7005	1A - 6.3A

Electrical Characteristics

% of Ampere Rating	Opening Time	
	1A - 6.3A	8A - 10A
150%	1 Hour, Min.	1 Hour, Min.
210%	2 Minutes, Max.	300 s, Max.
275%	400 ms, Min. ; 10 Sec., Max.	1 s, Min. ; 20 s, Max.
400%	150 ms, Min. ; 3 Sec., Max.	150 ms, Min. ; 3 Sec., Max.
1000%	20 ms, Min. ; 150 ms, Max.	20 ms, Min. ; 150 ms, Max.

Electrical Characteristics

Amp Code	Rated Current	Voltage Rating	Breaking Capacity	Voltage Drop $1.0 \times I_N$ max. (mV)	Power Dissipation $1.5 \times I_N$ max. (mW)	Melting Integral $10 \times I_N$ min. (A ² s)	Agency Approvals					
												
1100	1.00 A	250 V	100A / 250VAC 50-60 Hz $\cos \phi = 1.0$	100	400	3.0	X	X	X	X	X	X
1125	1.25 A	250 V		95	465	4.5	X	X	X	X	X	X
1160	1.60 A	250 V		90	490	9.0	X	X	X	X	X	X
1200	2.00 A	250 V		85	670	12	X	X	X	X	X	X
1250	2.50 A	250 V		80	750	22	X	X	X	X	X	X
1315	3.15 A	250 V		75	900	32	X	X	X	X	X	X
1400	4.00 A	250 V		70	1200	58	X	X	X	X	X	X
1500	5.00 A	250 V		65	1250	90	G	X	X	X	QCC	X
1630	6.30 A	250 V		65	1400	105	G	X	X	X	CQC	X
1800	8.00 A	250 V		63	1600	180			X	X		
2100	10.00 A	250 V		57	1600	260			X	X		

Note: 1.00 means the number one with two decimal places. 1,000 means the number one thousand.

Temperature Rerating Curve

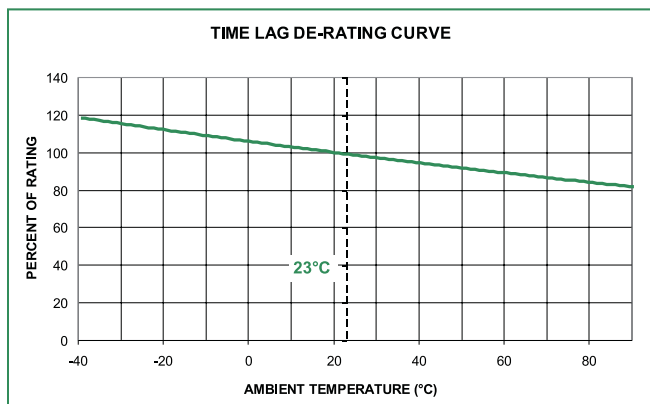

Average Time Current Curves

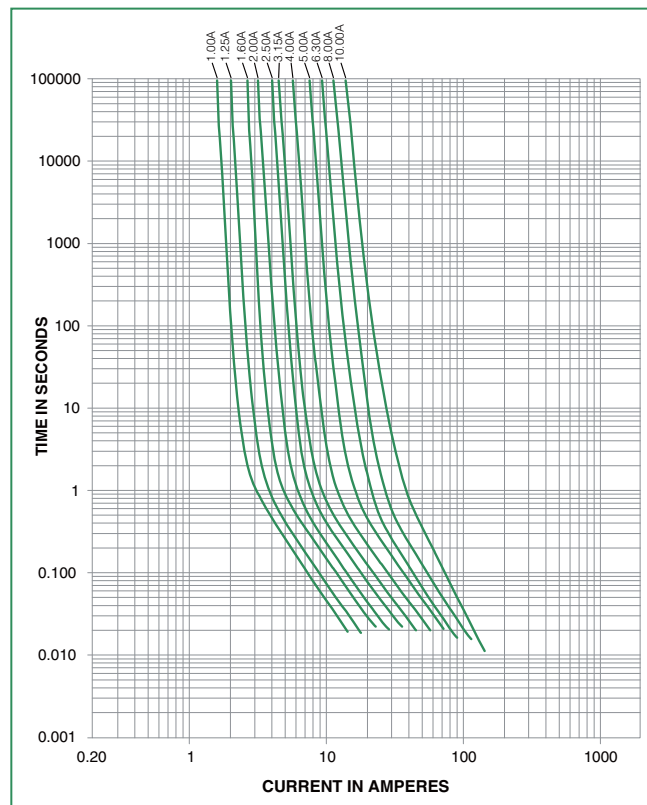

Soldering Parameters - Wave Soldering

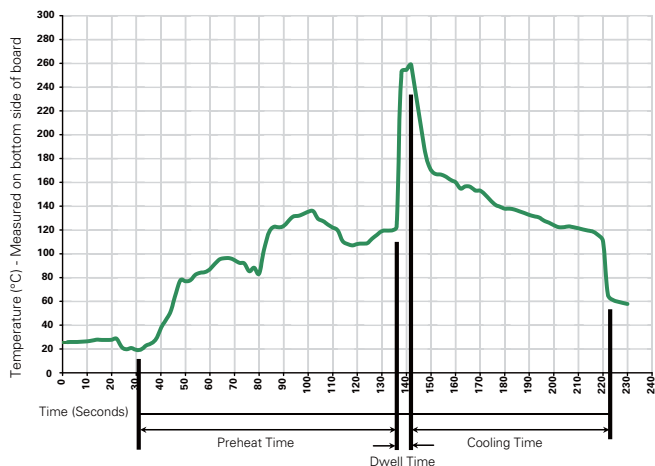

Recommended Process Parameters:

Wave Parameter	Lead-Free Recommendation
Preheat: (Depends on Flux Activation Temperature)	(Typical Industry Recommendation)
Temperature Minimum:	100° C
Temperature Maximum:	150° C
Preheat Time:	60-180 seconds
Solder Pot Temperature:	260° C Maximum
Solder Dwell Time:	2-5 seconds

Recommended Hand-Solder Parameters:

Solder Iron Temperature: 350° C +/- 5° C
 Heating Time: 5 seconds max.

Note: These devices are not recommended for IR or Convection Reflow process.

Product Characteristics

Materials	Base/Cap: Brown Thermoplastic Polyamide PA 6.6, UL 94 V-0 Round Pins: Copper, Tin-plated
Lead Pull Strength	10 N (EN 60068-2-21)
Solderability	260°C, ≤ 3s. (Wave) 350°C, ≤ 1s. (Soldering Iron)
Soldering Heat Resistance	260°C, 10s. (IEC 60068-2-20) 350°C, 3s. (Soldering Iron)

Operating Temperature	-40°C to +85°C (consider de-rating)
Climatic Category	-40°C to +85°C /21 days (EN 60068-1,-2-1,-2-2,-2-78)
Stock Conditions	+10°C to +60°C RH ≤ 75% yearly average, without dew, maximum value for 30 days-95%
Vibration Resistance	24 cycles at 15 min. each (EN 60068-2-6) 10 - 60 Hz at 0.75 mm amplitude 60 - 2000 Hz at 10 g acceleration

Dimensions

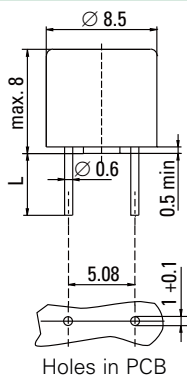

Long Leads (L=18.8mm)
 Short Leads (L=4.3mm)

Part Numbering System

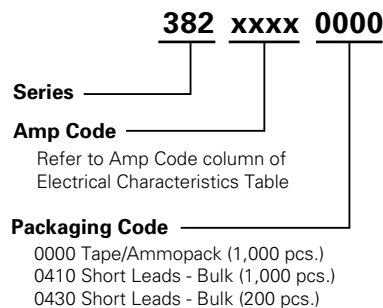

Packaging

Packaging Option	Packaging Specification	Quantity	Quantity & Packaging Code	Taping Width
382 Series				
Tape & Ampopack	N/A	1,000	0000	N/A
Short Leads	N/A	1,000	0410	N/A
Short Leads	N/A	200	0430	N/A

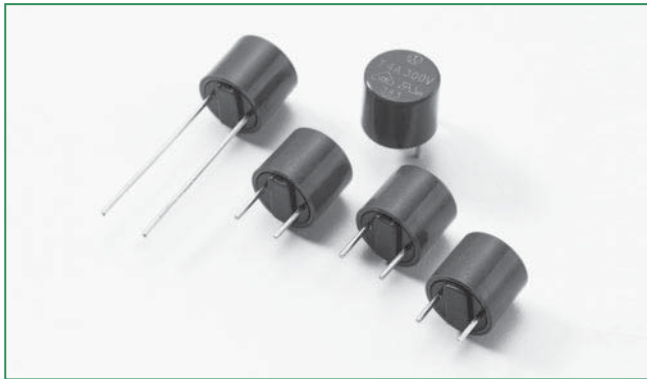
RoHS **Pb** **383 Series, TR5®, Time-Lag Fuse**

Description

TR5®, Time-lag type, 300V rated and designed in accordance to IEC60127-3.

Features

- Lead-free
- Reduced PCB space requirements
- Direct solderable or plug-in versions
- Internationally approved
- Low internal resistance
- Shocksafe casing
- Vibration resistant
- Halogen free

Applications

- Electronic Ballast

Agency Approvals

Agency	Agency File Number	Ampere Range
	5007679-1170-0038/92585	4A - 5A
	JET1896-31007-2001 JET1896-31007-1003	1A - 5A 6.3A - 10A
	E67006	1A - 10A

Electrical Characteristics for Series

% of Ampere Rating	Opening Time (1A-6.3A)
150%	1 Hour, Minimum
210%	120 sec., Maximum
275%	400 ms., Min.; 10 sec., Max.
400%	150 ms., Min.; 3 sec., Max.
1000%	20 ms., Min.; 150 ms., Max.

Electrical Characteristics for Series

% of Ampere Rating	Opening Time (8A-10A)
150%	1 Hour, Minimum
210%	300 sec., Maximum
275%	1 sec., Min.; 20 sec., Max.
400%	150 ms., Min.; 3 sec., Max.
1000%	20 ms., Min.; 150 ms., Max.

Electrical Characteristics Specifications by Item

Amp Code	Amp Rating (A)	Max Voltage Rating (V)	Breaking Capacity 50-60Hz/cosφ =1	Voltage Drop 1.0 x I _N max. (mV)	Power Dissipation 1.5 x I _N max. (mW)	Melting Integral 10 x I _N min. (A ² s)	Agency Approvals		
1100	1.00	300	100A@300VAC 50A@300VAC	100	400	3.0		X	X
1125	1.25	300		95	465	4.5		X	X
1160	1.60	300		90	490	9.0		X	X
1200	2.00	300		85	670	12		X	X
1250	2.50	300		80	750	22		X	X
1315	3.15	300		75	900	32		X	X
1400	4.00	300		70	1200	58		X	X
1500	5.00	300	50A@300VAC	65	1250	90	X	X	X
1630	6.30	300		65	1400	105			X
1800	8.00	300		63	1600	180			X
2100	10.00	300		57	1600	260			X

Note: 1.00 means the number one with two decimal places. 1,000 means the number one thousand.

Temperature Derating Curve

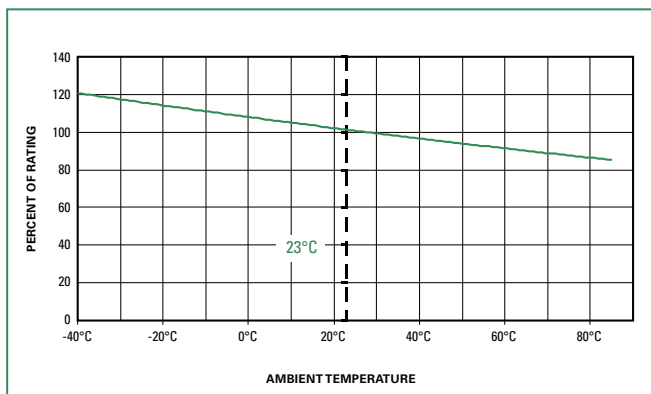

Average Time Current Curves

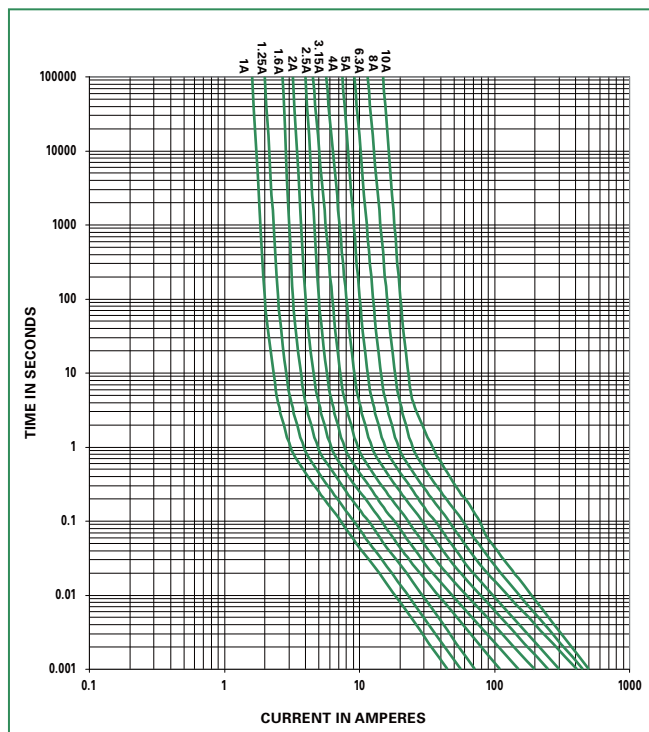

Soldering Parameters - Wave Soldering

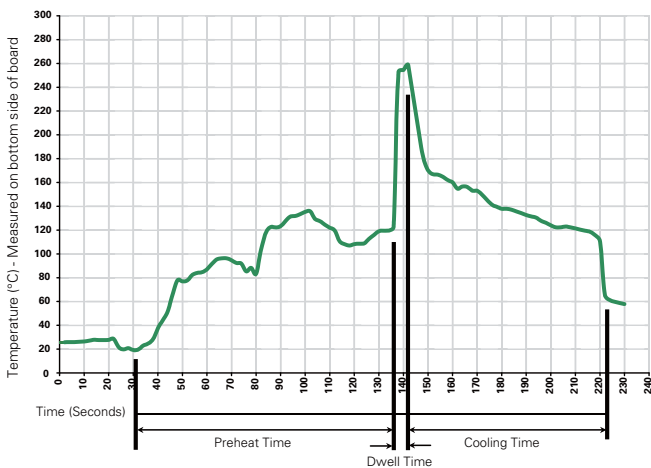

Recommended Process Parameters:

Wave Parameter	Lead-Free Recommendation
Preheat: (Depends on Flux Activation Temperature)	(Typical Industry Recommendation)
Temperature Minimum:	100° C
Temperature Maximum:	150° C
Preheat Time:	60-180 seconds
Solder Pot Temperature:	260° C Maximum
Solder Dwell Time:	2-5 seconds

Recommended Hand-Solder Parameters:

Solder Iron Temperature: 350° C +/- 5° C
 Heating Time: 5 seconds max.

Note: These devices are not recommended for IR or Convection Reflow process.

Product Characteristics

Materials	Base/Cap: Brown Thermoplastic Polyamide PA6.6, UL 94 V0 Round Pins: tin-plated Copper
Lead Pull Strength	10 N (IEC 60068-2-21)
Solderability	260°C, ≤ 3s (Wave) 350°C, ≤ 1s (Soldering Iron)
Soldering Heat Resistance	260°C, 10s (IEC60068-2-20) 350°C, 3s (Soldering Iron)

Operating Temperature	-65°C to +125°C (based on internal thermal cycle test up 125°C consider de-rating)
Climatic Category	-40°C / +85°C / 21 days (EN60068-1,-2-1,-2-2,-2-78)
Stock Condition	+10°C to +60°C relative humidity 75% yearly average, without dew, maximum value for 30 days-95%
Vibration Resistance	24 cycles at 15min. Each (EN60068-2-6) 10 - 60 Hz at 0.75 mm amplitude 60 - 2000 Hz at 10g acceleration

Dimensions

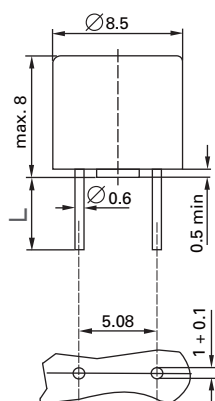

Holes in PCB

Long Leads (L=18.8mm)
Short Leads (L=4.3mm)

Part Numbering System

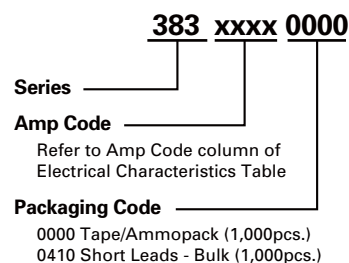

Packaging

Packaging Option	Packaging Specification	Quantity	Quantity & Packaging Code	Taping Width
383 Series				
Tape & Ammopack	N/A	1,000	0000	N/A
Short Leads	N/A	1,000	0410	N/A

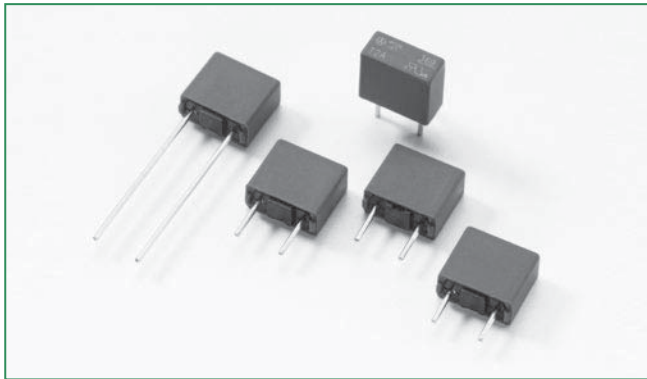

Agency Approvals

Agency	Agency File Number	Ampere Range
UL US	E67006	1A - 6.3A
JET	JET 1896-31007-2002	1A - 5A

Description

TE5®, Time-lag type, 300V rated and designed in accordance to IEC60127-3.

Features

- Lead-free
- Reduced PCB space requirements
- Direct solderable or plug-in versions
- Internationally approved
- Low internal resistance
- Shocksafe casing
- Vibration resistant
- Halogen free

Applications

- Electronic Ballast

Electrical Characteristics for Series

% of Ampere Rating	Opening Time
150%	1 Hour, Minimum
210%	120 sec., Maximum
275%	400 ms., Min.; 10 sec., Max.
400%	150 ms., Min.; 3 sec., Max.
1000%	20 ms., Min.; 150 ms., Max.

Electrical Characteristics Specifications by Item

Amp Code	Amp Rating (A)	Voltage Rating (V)	Breaking Capacity	Voltage Drop 1.0 x I _N max. (mV)	Power Dissipation 1.5 x I _N max. (mW)	Melting Integral 10 x I _N min. (A ² s)	Agency Approvals	
							UL US	JET
1100	1.00	300	50A@300VAC 50-60Hz/cosφ = 1	115	400	5.80	X	X
1160	1.60	300		95	600	13.50	X	X
1200	2.00	300		90	700	21.00	X	X
1315	3.15	300		80	1100	55.00	X	X
1400	4.00	300		75	1200	100.00	X	X
1500	5.00	300		70	1000	90.00	X	X
1630	6.30	300		65	1200	126.00	X	X

Temperature Derating Curve

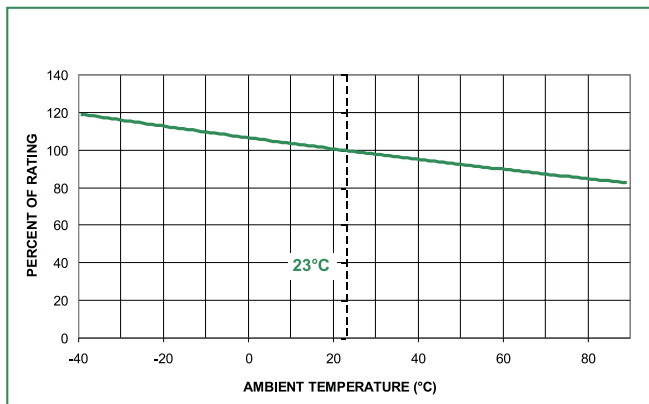

Average Time Current Curves

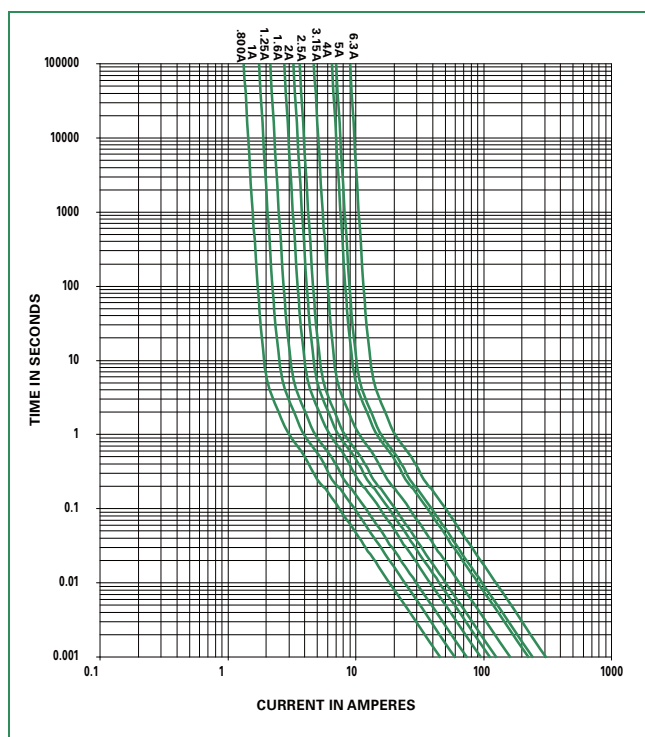

Soldering Parameters - Wave Soldering

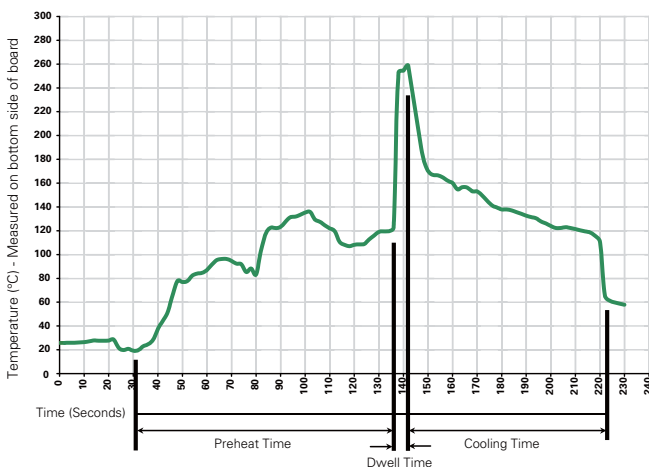

Recommended Process Parameters:

Wave Parameter	Lead-Free Recommendation
Preheat: (Depends on Flux Activation Temperature)	(Typical Industry Recommendation)
Temperature Minimum:	100° C
Temperature Maximum:	150° C
Preheat Time:	60-180 seconds
Solder Pot Temperature:	260° C Maximum
Solder Dwell Time:	2-5 seconds

Recommended Hand-Solder Parameters:

Solder Iron Temperature: 350° C +/- 5° C
 Heating Time: 5 seconds max.

Note: These devices are not recommended for IR or Convection Reflow process.

Product Characteristics

Materials	Base/Cap: Brown Thermoplastic Polyamide PA6.6, UL 94 V0 Round Pins: Tin-plated Copper
Lead Pull Strength	10 N (IEC 60068-2-21)
Solderability	260°C, ≤ 3s (Wave) 350°C, ≤ 1s (Soldering Iron)
Soldering Heat Resistance	260°C, 10s (IEC60068-2-20) 350°C, 3s (Soldering Iron)

Operating Temperature	-40°C to +85°C (consider de-rating)
Climatic Category	-40°C / +85°C / 21 days (EN60068-1,-2-1,-2-2,-2-78)
Stock Condition	+10°C to +60°C relative humidity 75% yearly average, without dew, maximum value for 30 days-95%
Vibration Resistance	24 cycles at 15min. Each (EN60068-2-6) 10 - 60 Hz at 0.75 mm amplitude 60 - 2000 Hz at 10g acceleration

Dimensions

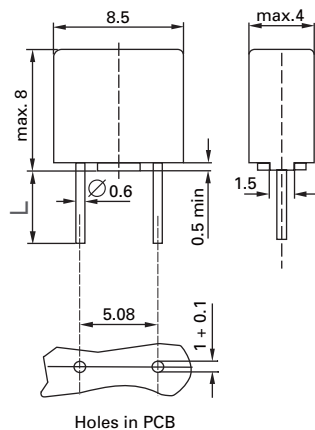

Long Leads (L=18.8mm)
Short Leads (L=4.3mm)

Part Numbering System

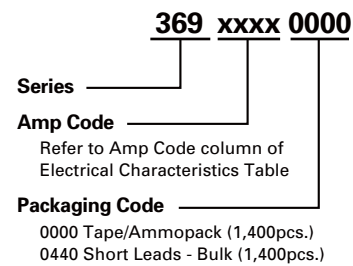

Packaging

Packaging Option	Packaging Specification	Quantity	Quantity & Packaging Code	Taping Width
369 Series				
Tape & Ammopack	N/A	1,400	0000	N/A
Short Leads	N/A	1,400	0440	N/A

RoHS **Pb** **385 Series, TE5®, Telecom Interface Protector Fuse**

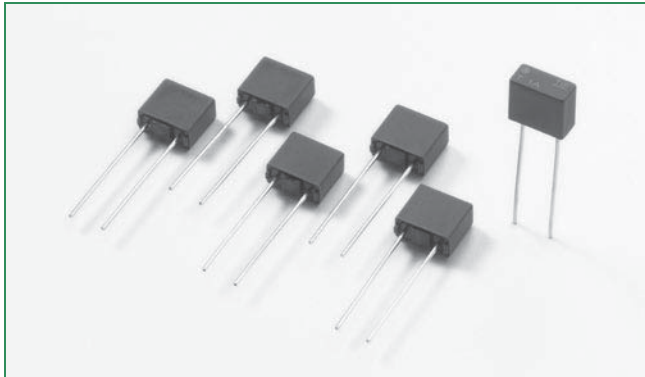

Description

The 385 Series are TE5®, protector, time-Lag type, 125V rated fuses, that are designed in accordance to UL 248-14.

Features

- Surge proof for telecom applications
- Reduced PCB space requirements
- Highly defined cut-off times
- Low internal resistance
- Irreversible physical separation
- Flame resistant encapsulated casing
- Available from 350mA to 1.5A

Applications

- Battery chargers
- Consumer Electronics
- Power supplies
- Industrial controllers

Electrical Characteristics

% of Ampere Rating	Opening Time
100%	2 Hours, Max.
300%	300 ms, Min. ; 5 Seconds, Max.

Agency Approvals

Agency	Agency File Number	Ampere Range
UL US	E67006	350mA - 1.5A

Electrical Characteristics

Amp Code	Rated Current	Voltage Rating	Breaking Capacity	Voltage Drop 1.0 x I _N max. (mV)	Power Dissipation 1.0 x I _N max. (mW)	Melting Integral 10 x I _N min. (A ² s)	Surge Amplitude (A) ¹			Agency Approvals UL US
							FCC	Bellcore	ITU	
0350	350mA	125V	50 A / 125 VAC 50-60 Hz cosφ=1.0	250	90	0.6	32	19	36	x
0500	500mA	125V		220	110	1.2	48	26	61	x
0800	800mA	125V		170	130	2.7	80	42	67	x
1100	1.00A	125V		140	130	4.5	100	52	67	x
1125	1.25A	125V		125	140	6.7	128	65	67	x
1150	1.50A	125V		120	170	9.0	155	78	67	x

¹ FCC 47 Part 68: Minimum pulse load quantity is 2 pulses at a test generator output of 800V and 10x560µs waveform.
 ITU-T K.20: Minimum pulse load quantity is 30 pulses at a test generator output of 1000V, 67A and 10x700µs waveform.
 Bellcore GR-1089: Minimum pulse load quantity is 50 pulses at a test generator output of 1000V and 10x1000µs.
 Note: 1.00 means the number one with two decimal places. 1,000 means the number one thousand.

385 Series

Temperature Derating Curve

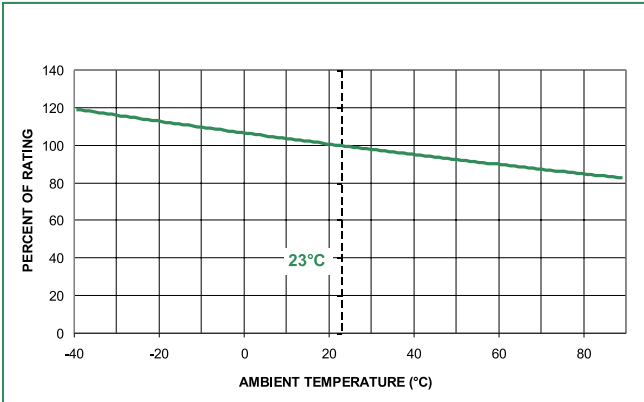

Average Time Current Curves

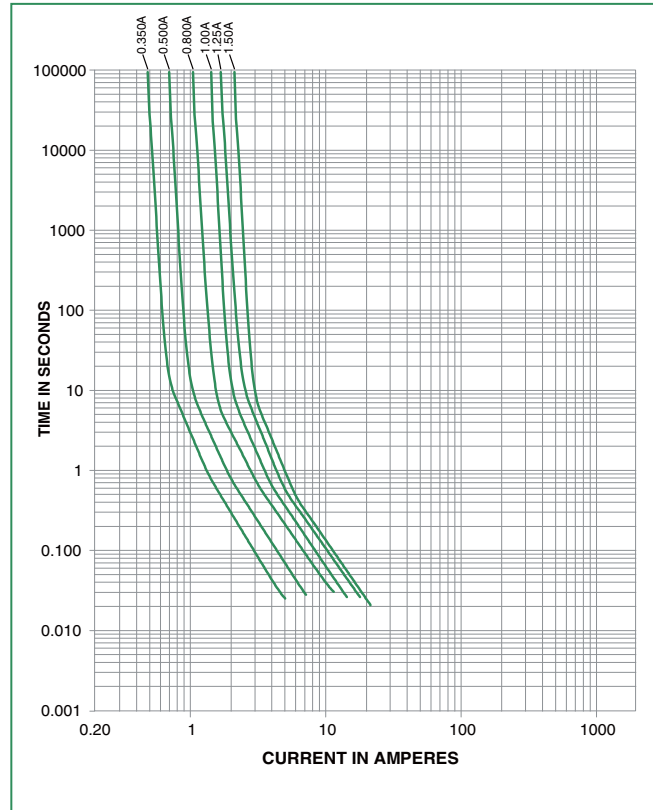

Soldering Parameters - Wave Soldering

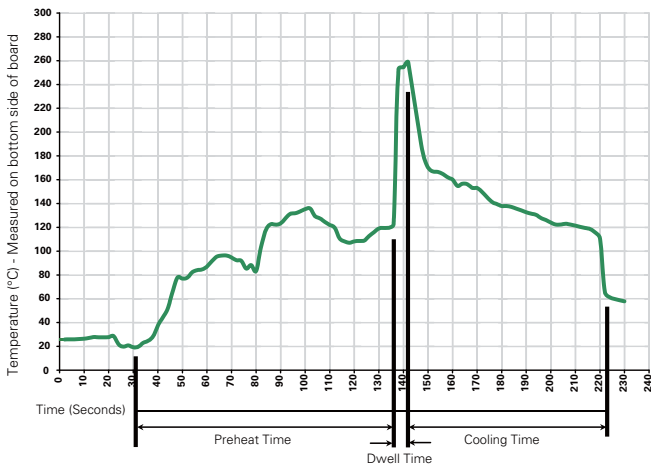

Recommended Process Parameters:

Wave Parameter	Lead-Free Recommendation
Preheat: (Depends on Flux Activation Temperature)	(Typical Industry Recommendation)
Temperature Minimum:	100° C
Temperature Maximum:	150° C
Preheat Time:	60-180 seconds
Solder Pot Temperature:	260° C Maximum
Solder Dwell Time:	2-5 seconds

Recommended Hand-Solder Parameters:

Solder Iron Temperature: 350° C +/- 5° C
Heating Time: 5 seconds max.

Note: These devices are not recommended for IR or Convection Reflow process.

Product Characteristics

Materials	Base/Cap: Brown Thermoplastic Polyamide PA 6.6, UL 94V-0 Round Pins: Copper, Tin-plated
Lead Pull Strength	10N (EN 60068-2-21)
Solderability	260°C, ≤ 3s. (Wave) 350°C, ≤ 1s. (Soldering Iron)
Soldering Heat Resistance	260°C, 10s. (IEC 60068-2-20) 350°C, 3s. (Soldering Iron)

Operating Temperature	-40°C to +85°C (consider de-rating)
Climatic Category	-40°C to +85°C/21 days (EN 60068-1,-2-1,-2-2,-2-78)
Stock Conditions	+10 °C to +60 °C RH, ≤ 75% yearly average, without dew, maximum value for 30 days-95%
Vibration Resistance	24 cycles at 15 min. each (EN 60068-6) 10 - 60 Hz at 0.75 mm amplitude 60 - 2000 Hz at 10 g acceleration

Dimensions

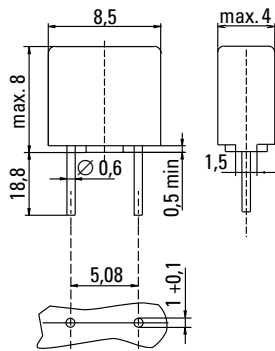

Dimensions (mm)
Holes in PCB
Long Leads (L=18.8mm)

Part Numbering System

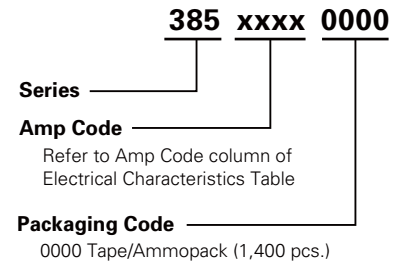

Packaging

Packaging Option	Packaging Specification	Quantity	Quantity & Packaging Code	Taping Width
385 Series				
Tape & Ampack	N/A	1,400	0000	N/A

385 Series

RoHS **Pb** **391 Series, TE5®, Fast-Acting Fuse**

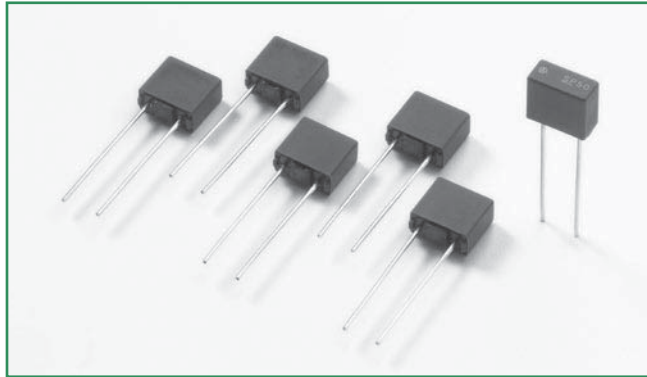

Description

The 391 Series are TE5® short circuit protector, fast-acting type, 65V rated fuses. For Short Circuit Protection of Sensitive Electronic Components and Assemblies.

Features

- For worldwide applications
- Reduced PCB space requirements
- Highly defined cut-off times
- Irreversible physical separation
- Low internal resistance
- Flame resistant encapsulated casing
- RoHS compliant and Lead-free
- Available from 125mA to 4A.

Applications

- Battery chargers
- Consumer Electronics
- Power supplies
- Industrial controllers

Agency Approvals

Agency	Agency File Number	Ampere Range
	E67006	125mA - 4A

Electrical Characteristics

% of Ampere Rating	Opening Time
300	2 Seconds, Max.

Electrical Characteristics

Amp Code	Rated Current	Marking Code*	Voltage Rating	Breaking Capacity	Cold Resistance 0.1 x I _N max. (mΩ)	Power Dissipation 1.0 x I _N max. (mW)	Melting Integral 10 x I _N max. (A ² s)	Agency Approvals
0125	125 mA	SP13	65 V	50A / 65 VAC/DC 50-60 Hz cosφ=1.0	3400	190	0.005	x
0160	160 mA	SP16	65 V		2450	210	0.0095	x
0200	200 mA	SP20	65 V		1750	240	0.019	x
0250	250 mA	SP25	65 V		195	52	0.012	x
0315	315 mA	SP32	65 V		155	65	0.018	x
0400	400 mA	SP40	65 V		120	85	0.034	x
0500	500 mA	SP50	65 V		95	105	0.057	x
0630	630 mA	SP63	65 V		75	135	0.095	x
0800	800 mA	SP80	65 V		58	170	0.16	x
1100	1.00 A	SP100	65 V		46	220	0.27	x
1125	1.25 A	SP125	65 V		37	270	0.45	x
1160	1.60 A	SP160	65 V		29	350	0.77	x
1200	2.00 A	SP200	65 V		23	440	0.85	x
1250	2.50 A	SP250	65 V		18	550	2.2	x
1315	3.15 A	SP315	65 V		14	700	3.7	x
1400	4.00 A	SP400	65 V		12	900	6.5	x

* Physical Marking on top of the device

Temperature Derating Curve

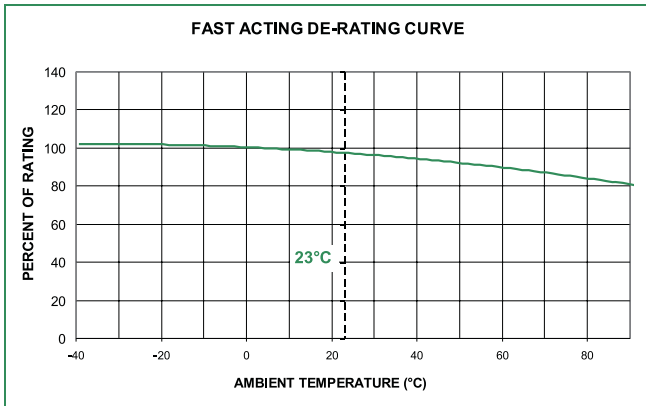

Average Time Current Curves

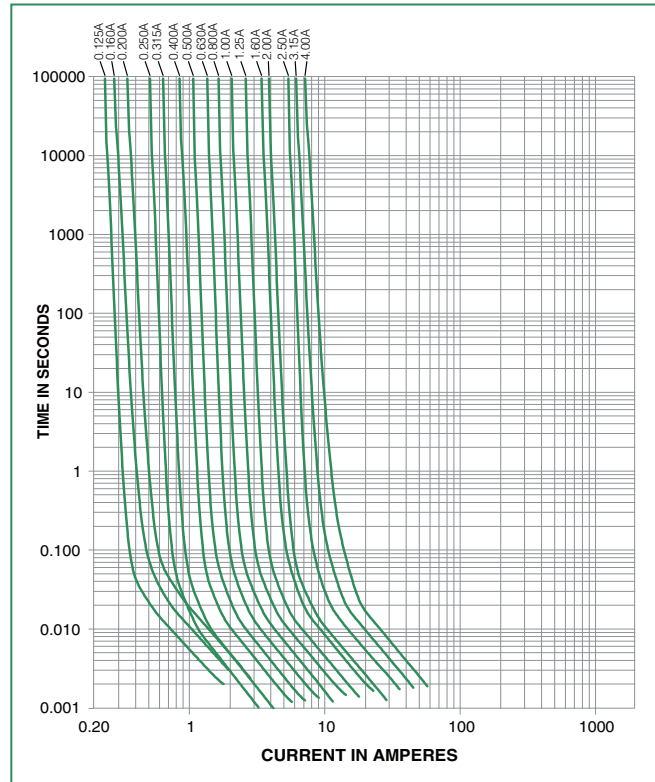

Soldering Parameters - Wave Soldering

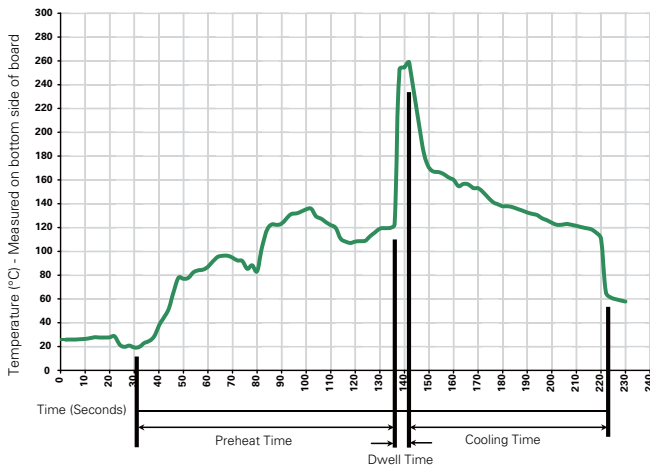

Recommended Process Parameters:

Wave Parameter	Lead-Free Recommendation
Preheat: (Depends on Flux Activation Temperature)	(Typical Industry Recommendation)
Temperature Minimum:	100° C
Temperature Maximum:	150° C
Preheat Time:	60-180 seconds
Solder Pot Temperature:	260° C Maximum
Solder Dwell Time:	2-5 seconds

Recommended Hand-Solder Parameters:

Solder Iron Temperature: 350° C +/- 5° C
Heating Time: 5 seconds max.

Note: These devices are not recommended for IR or Convection Reflow process.

Product Characteristics

Materials	Base/Cap: Brown Thermoplastic Polyamide PA 6.6, UL 94V-0 Round Pins: Copper, Tin-plated
Lead Pull Strength	10 N (EN 60068-2-21)
Solderability	260°C, ≤ 3s. (Wave) 350°C, ≤ 1s. (Soldering Iron)
Soldering Heat Resistance	260°C, 10s. (IEC 60068-2-20) 350°C, 3s. (Soldering Iron)

Operating Temperature	-40°C to +85°C (consider de-rating)
Climatic Category	-40°C to +85°C/21 days (EN 60068-1,-2-1,-2-2,-78)
Stock Conditions	+10 °C to +60 °C RH, ≤ 75% yearly average, without dew, maximum value for 30 days-95%
Vibration Resistance	24 cycles at 15 min. each (EN 60068-6) 10 - 60 Hz at 0.75 mm amplitude 60 - 2000 Hz at 10 g acceleration

Dimensions

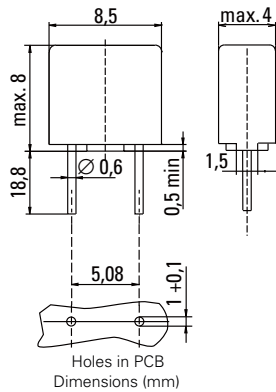

Part Numbering System

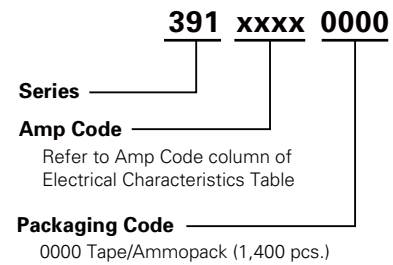

Packaging

Packaging Option	Packaging Specification	Quantity	Quantity & Packaging Code	Taping Width
391 Series				
Tape & Ampmpack	N/A	1,400	0000	N/A

RoHS  **392 Series, TE5®, Time-Lag Fuse**

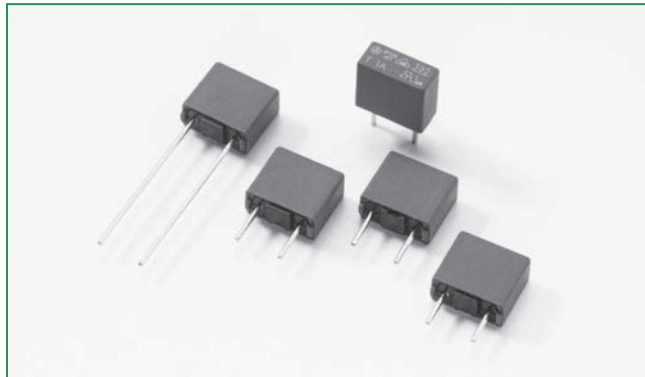

Description

TE5®, time-Lag type, 250V rated, designed in accordance to IEC 60127-3.







Features

- Lead-free approved
- Reduced PCB space requirements
- Direct solderable or plug-in versions
- Internationally
- Low internal resistance
- Shock safe casing
- Vibration resistant
- Halogen free

Applications

- Battery Charges
- Consumer Electronics
- Power supplies
- Industrial Controllers







Agency Approvals

Agency	Agency File Number	Ampere Range
	5007679-1170-0007/82577	800mA - 6.3A
	709069, 710076	800mA - 6.3A
	E67006	800mA - 6.3A
	JET1896-31007-2002	1A - 5A
	CQC07012021162	800mA - 6.3A
	SU05024-7013 SU05024-7014 SU05024-7015 SU05024-7016 SU05024-7017 SU05024-7018	800mA - 6.3A

Electrical Characteristics for Series

% of Ampere Rating	Opening Time
150%	1 Hour, Min.
210%	120 s, Max.
275%	400 ms Min. ; 10 Sec. Max.
400%	150 ms Min. ; 3 Sec. Max.
1000%	20 ms Min. ; 150 ms Max.

Electrical Characteristic Specifications by Item

Amp Code	Rated Current	Voltage Rating	Breaking Capacity	Voltage Drop 1.0 x I _N max. (mV)	Power Dissipation 1.5 x I _N max. (mW)	Melting Integral 10 x I _N min. (A ² s)	Agency Approvals					
												
0800	800 mA	250V	25A/250 VAC	110	280	3.80	x	x	x		x	x
1100	1.00 A	250V	25A/250 VAC	115	400	5.80	x	x	x	x	x	x
1125	1.25 A	250V	25A/250 VAC	100	500	9.75	x	x	x	x	x	x
1160	1.60 A	250V	25A/250 VAC	95	600	13.50	x	x	x	x	x	x
1200	2.00 A	250V	25A/250 VAC	90	700	21.00	x	x	x	x	x	x
1250	2.50 A	250V	25A/250 VAC	85	750	32.00	x	x	x	x	x	x
1315	3.15 A	250V	32A/250 VAC	80	1100	55.00	x	x	x	x	x	x
1400	4.00 A	250V	40A/250 VAC	75	1200	100.00	x	x	x	x	x	x
1500	5.00 A	250V	50A/250 VAC	70	1000	90.00	x	x	x	x	x	x
1630	6.30 A	250V	63A/250 VAC	65	1200	126.00	x	x	x		x	x

Note: 1.00 means the number one with two decimal places. 1,000 means the number one thousand.

392 Series

Temperature Derating Curve

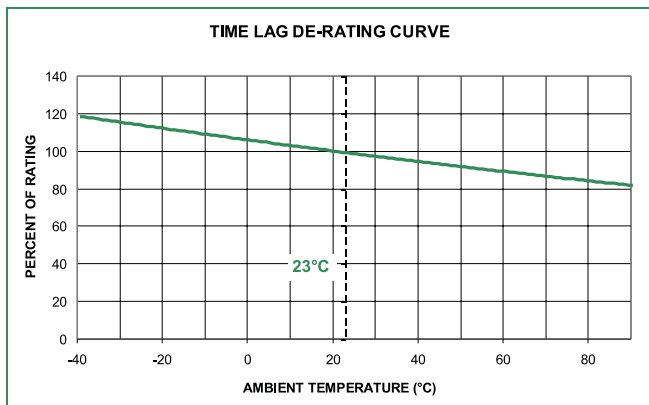

Average Time Current Curves

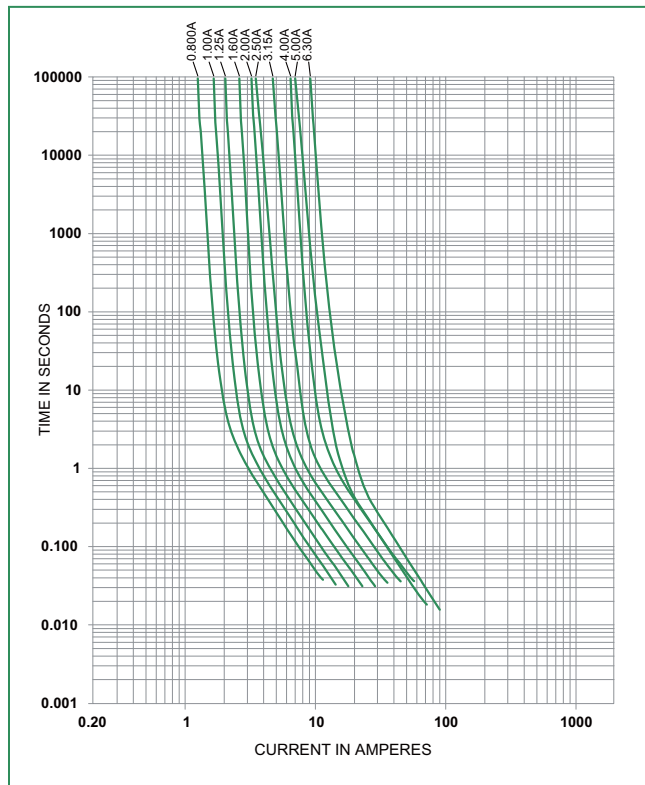

Soldering Parameters - Wave Soldering

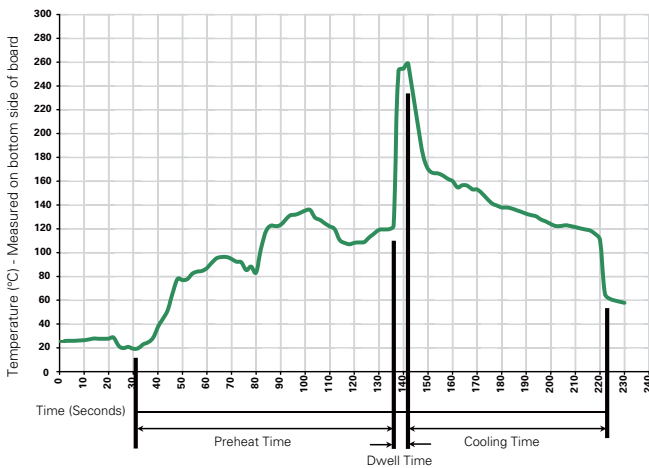

Recommended Process Parameters:

Wave Parameter	Lead-Free Recommendation
Preheat: (Depends on Flux Activation Temperature)	(Typical Industry Recommendation)
Temperature Minimum:	100° C
Temperature Maximum:	150° C
Preheat Time:	60-180 seconds
Solder Pot Temperature:	260° C Maximum
Solder Dwell Time:	2-5 seconds

Recommended Hand-Solder Parameters:

Solder Iron Temperature: 350° C +/- 5° C
 Heating Time: 5 seconds max.

Note: These devices are not recommended for IR or Convection Reflow process.

Product Characteristics

Materials	Base/Cap: Brown Thermoplastic Polyamide PA 6.6, UL 94 V-0 Round Pins: Copper, Tin-plated
Lead Pull Strength	10 N (IEC 60068-2-21)
Solderability	260°C, ≤ 3 sec. (Wave) 350°C, ≤ 3 sec. (Soldering iron)
Soldering Heat Resistance	260°C, 10 sec. (IEC 60068-2-20) 350°C, ≤ 3 sec. (Soldering iron)

Operating Temperature	*-40°C to +125°C (consider de-rating)
Climatic Category	-40°C to +85°C/21 days (EN 60068-1,-2-1,-2-2,-2-78)
Stock Conditions	+10 °C to +60 °C RH ≤ 75% yearly average, without dew, maximum value for 30 days-95%
Vibration Resistance	24 cycles at 15 min. each (EN 60068-2-6) 10 - 60 Hz at 0.75 mm amplitude 60 - 2000 Hz at 10 g acceleration

* Internal test conditions from thermal cycling at 125°C

Dimensions

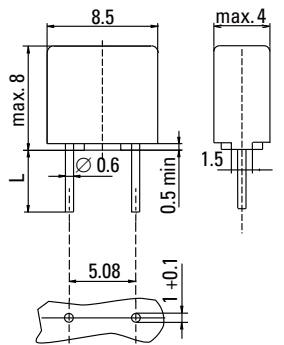

Holes in PCB
 Long Leads (L=18.8mm)
 Short Leads (L=4.3mm)

Part Numbering System

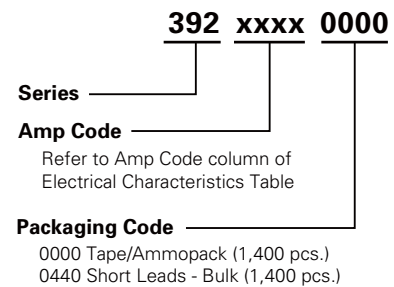

Packaging

Packaging Option	Packaging Specification	Quantity	Quantity & Packaging Code	Taping Width
392 Series				
Tape & Ammopack	N/A	1,400	0000	N/A
Short Leads	N/A	1,400	0440	N/A

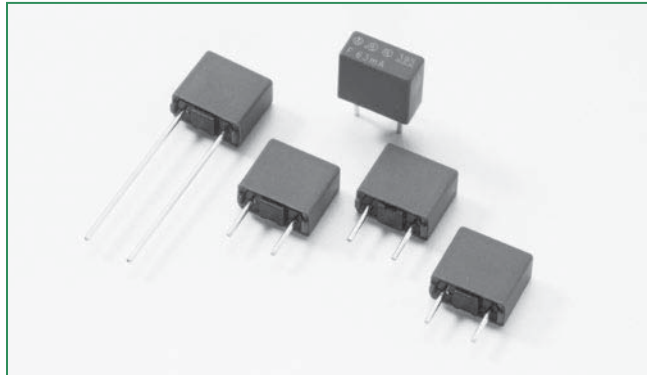

RoHS **395 Series, TE5®, Fast-Acting Fuse**

Description

The 395 Series are TE5®, fast-acting type, 125V rated fuses, designed in accordance to UL 248-14.

Features

- Lead-free
- Reduced PCB space requirements
- Direct solderable or plug-in versions
- Internationally approved
- Low internal resistance
- Shock safe casing
- Vibration resistant
- Halogen Free
- Available from 50mA to 6.3A

Agency Approvals

Agency	Agency File Number	Ampere Range
	File number: E 67006	50mA - 6.3A
	File number: E 67006	50mA - 6.3A
	JET1896-31007-1002	1A - 5A



Applications

- Battery chargers
- Consumer Electronics
- Power supplies
- Industrial controllers

Electrical Characteristics

% of Ampere Rating	Opening Time
200%	60 Seconds, Max.

Electrical Characteristics

Amp Code	Rated Current	Voltage Rating	Breaking Capacity	Voltage Drop 1.0 x I _N max. (mV)	Power Dissipation 1.0 x I _N max. (mW)	Melting Integral 10 x I _N max. (A ² s)	Agency Approvals		
									
0050	50mA	125V	100A / 125 VAC 50-60 Hz cos φ = 1.0	1600	85	0.0001	x	x	
0063	63mA	125V		1300	85	0.00013	x	x	
0080	80mA	125V		1200	100	0.0002	x	x	
0100	100mA	125V		1100	110	0.0013	x	x	
0125	125mA	125V		1350	160	0.0019	x	x	
0160	160mA	125V		1000	150	0.0037	x	x	
0200	200mA	125V		950	210	0.0075	x	x	
0250	250mA	125V		900	225	0.013	x	x	
0315	315mA	125V		800	255	0.026	x	x	
0400	400mA	125V		230	95	0.015	x	x	
0500	500mA	125V		220	110	0.025	x	x	
0630	630mA	125V		210	135	0.045	x	x	
0800	800mA	125V		200	160	0.068	x	x	
1100	1.00A	125V		190	190	0.13	x	x	x
1125	1.25A	125V		180	225	0.2	x	x	x
1160	1.60A	125V		170	275	0.39	x	x	x
1200	2.00A	125V		160	450	0.53	x	x	x
1250	2.50A	125V		150	375	1.1	x	x	x
1315	3.15A	125V		140	445	1.9	x	x	x
1400	4.00A	125V		130	520	3.2	x	x	x
1500	5.00A	125V	120	600	6.1	x	x	x	
1630	6.30A	125V	115	850	9.7	x	x		

Note: 1.00 means the number one with two decimal places. 1,000 means the number one thousand.

395 Series

Temperature Rerating Curve

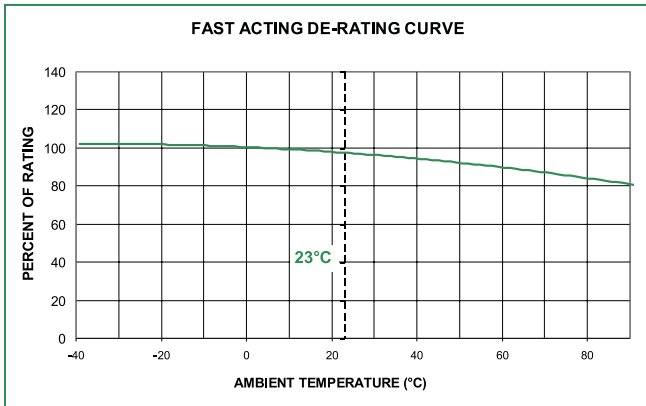

Average Time Current Curves

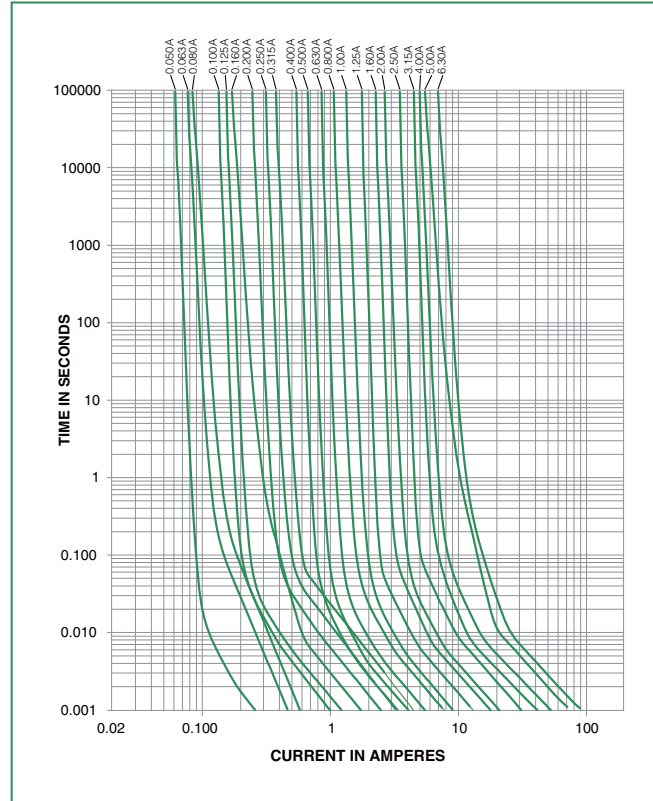

Soldering Parameters - Wave Soldering

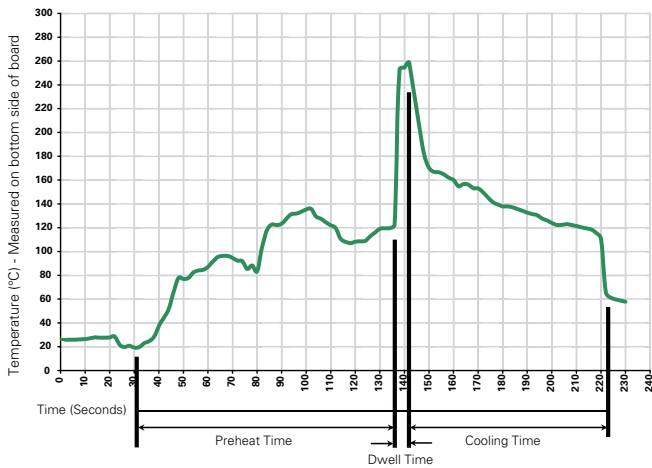

Recommended Process Parameters:

Wave Parameter	Lead-Free Recommendation
Preheat: (Depends on Flux Activation Temperature)	(Typical Industry Recommendation)
Temperature Minimum:	100° C
Temperature Maximum:	150° C
Preheat Time:	60-180 seconds
Solder Pot Temperature:	260° C Maximum
Solder Dwell Time:	2-5 seconds

Recommended Hand-Solder Parameters:

Solder Iron Temperature: 350° C +/- 5°C
Heating Time: 5 seconds max.

Note: These devices are not recommended for IR or Convection Reflow process.

Product Characteristics

Materials	Base/Cap: Brown Thermoplastic Polyamide PA 6.6, UL 94 V-0 Round Pins: Copper, Tin-plated
Lead Pull Strength	10 N (IEC 60068-2-21)
Solderability	260°C, ≤ 3s. (Wave) 350°C, ≤ 1s. (Soldering Iron)
Soldering Heat Resistance	260°C, 10s. (IEC 60068-2-20) 350°C, 3s. (Soldering Iron)

Operating Temperature	-40°C to +85°C (consider de-rating)
Climatic Category	-40°C to +85°C/21 days (EN 60068-1,-2-1,-2-2,-2-78)
Stock Conditions	+10 °C to +60 °C RH ≤ 75% yearly average, without dew, maximum value for 30 days-95%
Vibration Resistance	24 cycles at 15 min. each (EN 60068-2-6) 10 - 60 Hz at 0.75 mm amplitude 60 - 2000 Hz at 10 g acceleration

Dimensions

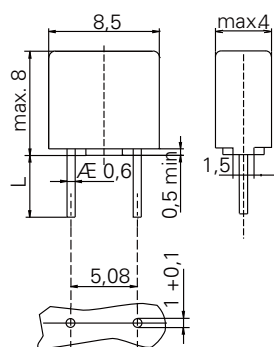

Holes in PCB
 Long Leads (L=18.8mm)
 Short Leads (L=4.3mm)

Part Numbering System

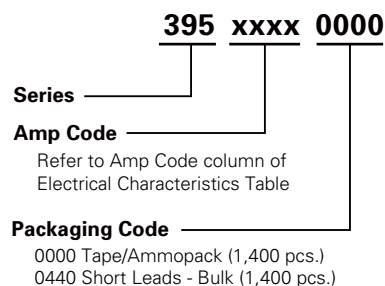

Packaging

Packaging Option	Packaging Specification	Quantity	Quantity & Packaging Code	Taping Width
395 Series				
Tape & Amp-pack	N/A	1,400	0000	N/A
Short Leads	N/A	1,400	0440	N/A

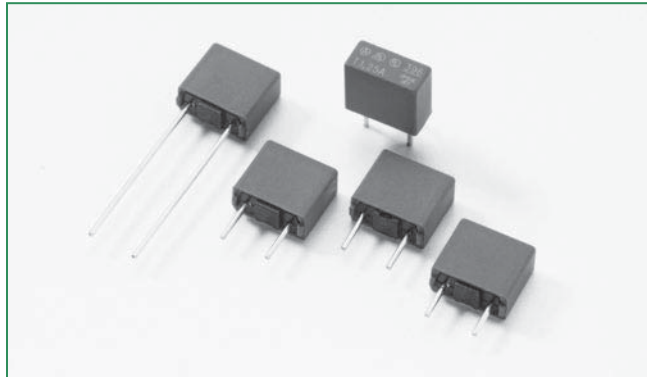
RoHS  **396 Series, TE5®, Time-Lag Fuse**

Description

The 396 Series are TE5®, time-Lag type, 125V rated, fuses, designed in accordance to UL 248-14.



Features

- Lead-free
- Reduced PCB space requirements
- Direct solderable or plug-in versions
- Internationally approved
- Low internal resistance
- Shock safe casing
- Vibration resistant
- Halogen free
- Available from 50mA to 6.3A

Applications

- Battery chargers
- Consumer Electronics
- Power supplies
- Industrial controllers



Agency Approvals

Agency	Agency File Number	Ampere Range
	File number: E 67006	50mA - 6.3A
	File number: E 67006	50mA - 6.3A
	JET1896-31007-1002	1A - 5A

Electrical Characteristics

% of Ampere Rating	Opening Time
200%	60 Seconds, Max.

Electrical Characteristics

Amp Code	Rated Current	Voltage Rating	Breaking Capacity	Voltage Drop 1.0 x I _N max. (mV)	Power Dissipation 1.0 x I _N max. (mW)	Melting Integral 10 x I _N min. (A ² s)	Agency Approvals		
									
0050	50mA	125V	100A / 125 VAC 50-60 Hz cos φ = 1.0	900	45	0.0056	x	x	
0063	63mA	125V		800	50	0.009	x	x	
0080	80mA	125V		700	55	0.014	x	x	
0100	100mA	125V		600	60	0.025	x	x	
0125	125mA	125V		550	70	0.044	x	x	
0160	160mA	125V		480	80	0.058	x	x	
0200	200mA	125V		390	80	0.1	x	x	
0250	250mA	125V		350	90	0.17	x	x	x
0315	315mA	125V		300	95	0.26	x	x	
0400	400mA	125V		250	100	0.32	x	x	
0500	500mA	125V		220	110	0.58	x	x	
0630	630mA	125V		210	135	0.75	x	x	
0800	800mA	125V		160	130	0.98	x	x	
1100	1.00A	125V		155	155	2.2	x	x	x
1125	1.25A	125V		145	185	3.8	x	x	x
1160	1.60A	125V		130	210	5.2	x	x	x
1200	2.00A	125V		125	250	7.5	x	x	x
1250	2.50A	125V		120	300	14	x	x	x
1315	3.15A	125V		110	350	22	x	x	x
1400	4.00A	125V		110	400	27	x	x	x
1500	5.00A	125V	95	475	59	x	x	x	
1630	6.30A	125V	95	570	100	x	x		

Note: 1.00 means the number one with two decimal places. 1,000 means the number one thousand.

Temperature Derating Curve

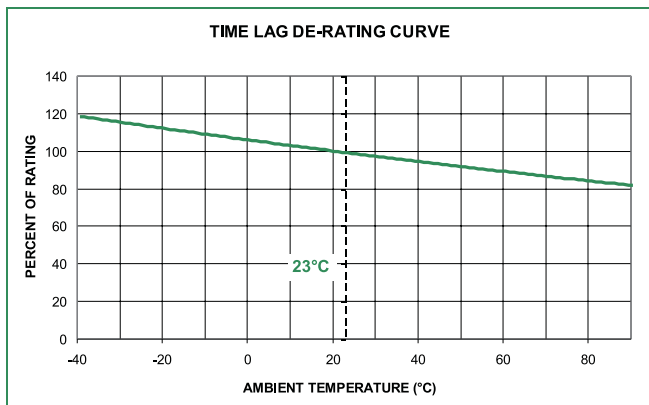

Average Time Current Curves

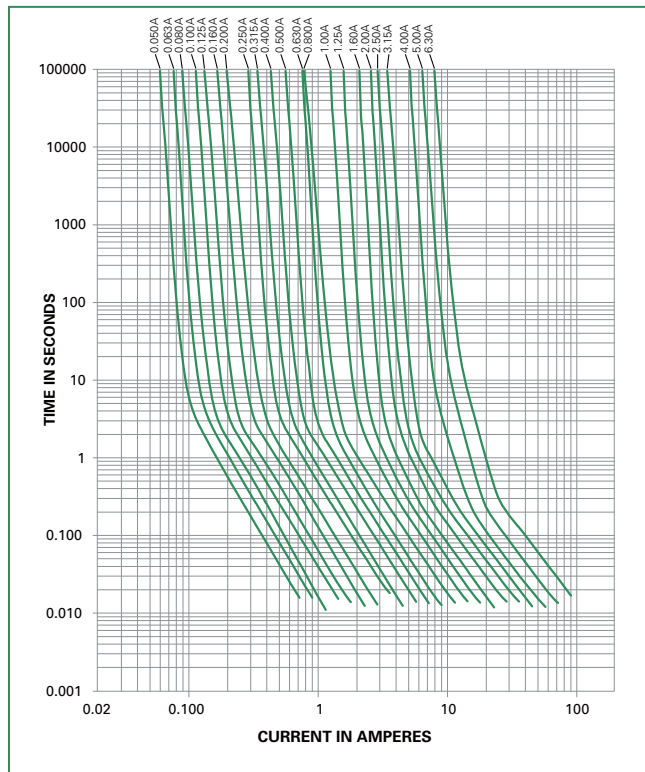

Soldering Parameters - Wave Soldering

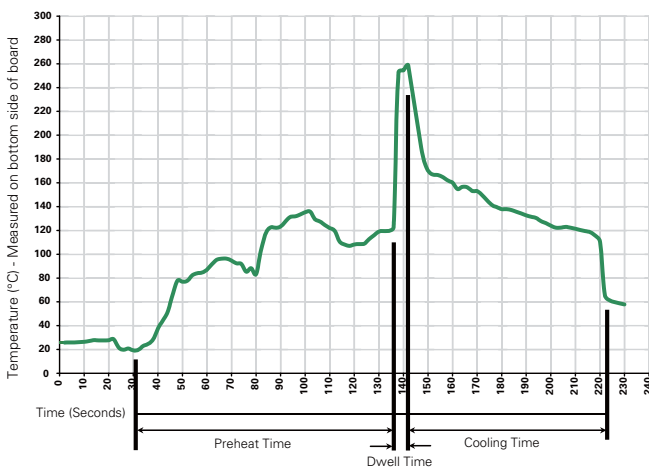

Recommended Process Parameters:

Wave Parameter	Lead-Free Recommendation
Preheat: (Depends on Flux Activation Temperature)	(Typical Industry Recommendation)
Temperature Minimum:	100° C
Temperature Maximum:	150° C
Preheat Time:	60-180 seconds
Solder Pot Temperature:	260° C Maximum
Solder Dwell Time:	2-5 seconds

Recommended Hand-Solder Parameters:

Solder Iron Temperature: 350° C +/- 5°C
 Heating Time: 5 seconds max.

Note: These devices are not recommended for IR or Convection Reflow process.

Product Characteristics

Materials	Base/Cap: Brown Thermoplastic Polyamide PA 6.6, UL 94 V-0 Round Pins: Copper, Tin-plated
Lead Pull Strength	10 N (IEC 60068-2-21)
Solderability	260°C, ≤ 3s. (Wave) 350°C, ≤ 1s. (Soldering Iron)
Soldering Heat Resistance	260°C, 10s. (IEC 60068-2-20) 350°C, 3s. (Soldering Iron)

Operating Temperature	-40°C to +85°C (consider de-rating)
Climatic Category	-40°C to +85°C/21 days (EN 60068-1,-2-1,-2-2,-2-78)
Stock Conditions	+10 °C to +60 °C RH ≤ 75% yearly average, without dew, maximum value for 30 days-95%
Vibration Resistance	24 cycles at 15 min. each (IEC 60068-2-6) 10 - 60 Hz at 0.75 mm amplitude 60 - 2000 Hz at 10 g acceleration

Dimensions

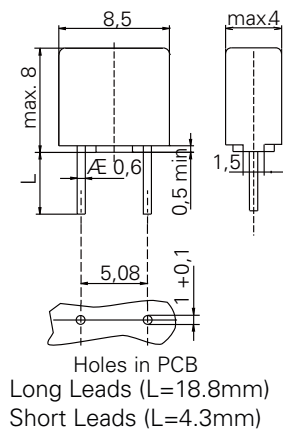

Part Numbering System

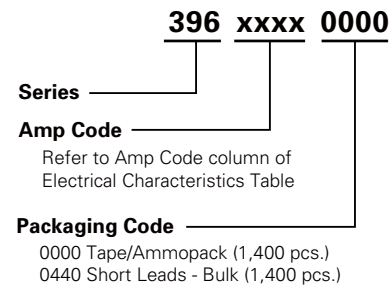

Packaging

Packaging Option	Packaging Specification	Quantity	Quantity & Packaging Code	Taping Width
396 Series				
Tape & Amp-pack	N/A	1,400	0000	N/A
Short Leads	N/A	1,400	0440	N/A

RoHS  **397 Series, TE5®, Transient Tolerant Fuse**

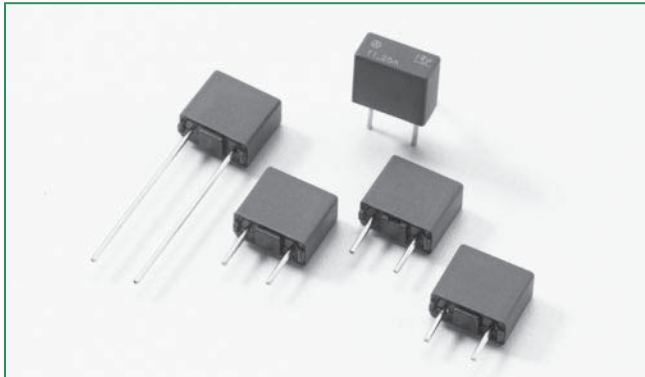



Description

The 397 Series are TE5®, time-Lag type, 125V rated fuses, designed in accordance to UL248-14.

Features

- Surge Proof for telecom applications
- Reduced PCB space requirements
- Direct solderable or plug-in versions
- Shock safe casing
- Vibration resistant
- Halogen free
- RoHS compliant and Lead-free
- Available from 350mA to 1.5A

Agency Approvals

Agency	Agency File Number	Ampere Range
	File No.: E67006	350mA - 1.5A
	File No.: E67006	350mA - 1.5A



Applications

- Battery chargers
- Consumer Electronics
- Power supplies
- Industrial controllers

Electrical Characteristics

% of Ampere Rating	Opening Time
200%	60 Seconds, Min.
570%	80 ms. Min. ; 2 Sec. Max.
1700%	200 s., Max.

Electrical Characteristics

Amp Code	Rated Current	Voltage Rating	Breaking Capacity	Voltage Drop 1.0 x I _N max. (mV)	Power Dissipation 1.0 x I _N max. (mW)	Melting Integral 10 x I _N min. (A ² s)	Surge Amplitude (A) ¹			Agency Approvals	
							FCC	Bellcore	ITU		
0350	350 mA	125 V	50A / 125 VAC 50-60 Hz cos φ = 1.0	400	140	0.38	25	15	29	x	x
0500	500 mA	125 V		340	170	0.79	30	17	38	x	x
0800	800 mA	125 V		300	240	2.4	60	31	50	x	x
1100	1.00 A	125 V		240	240	3.5	78	40	65	x	x
1125	1.25 A	125 V		200	250	5	100	50	67	x	x
1150	1.50 A	125 V		190	285	8.5	155	78	67	x	x

¹ FCC 47 Part 68: Minimum pulse load quantity is 2 pulses at a test generator output of 800 V and 10x560 μs waveform.

ITU-T K.20: Minimum pulse load quantity is 30 pulses at a test generator output of 1000 V, 67 A and 10x700 μs waveform.

Bellcore GR-1089: Minimum pulse load quantity is 50 pulses at a test generator output of 1000 V and 10x1000 μs.

Note: 1.00 means the number one with two decimal places. 1,000 means the number one thousand.

Temperature Derating Curve

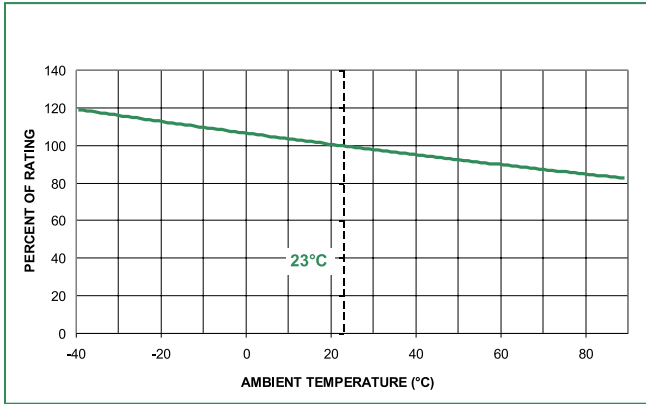

Average Time Current Curves

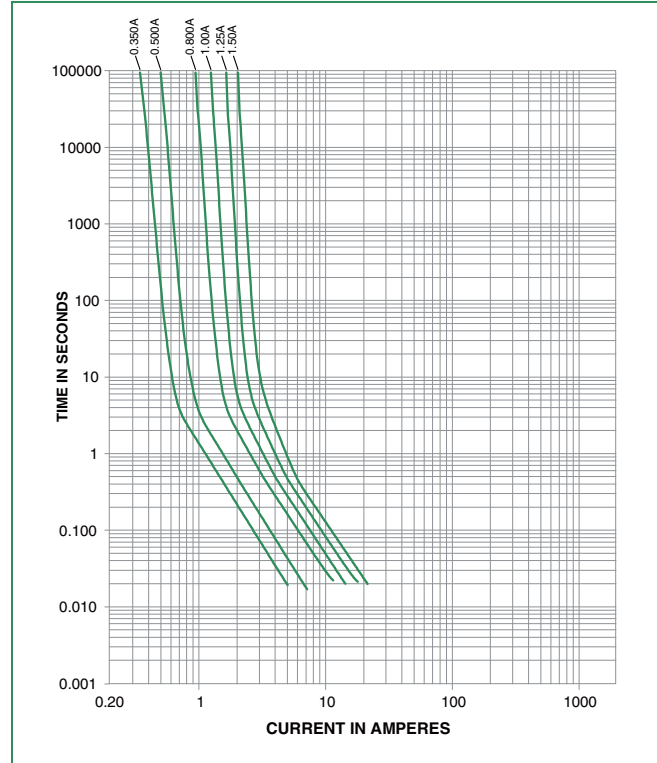

Soldering Parameters - Wave Soldering

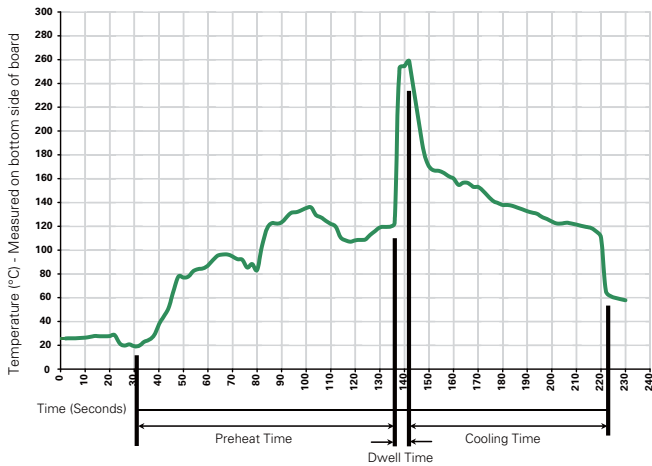

Recommended Process Parameters:

Wave Parameter	Lead-Free Recommendation
Preheat: (Depends on Flux Activation Temperature)	(Typical Industry Recommendation)
Temperature Minimum:	100° C
Temperature Maximum:	150° C
Preheat Time:	60-180 seconds
Solder Pot Temperature:	260° C Maximum
Solder Dwell Time:	2-5 seconds

Recommended Hand-Solder Parameters:

Solder Iron Temperature: 350° C +/- 5° C
Heating Time: 5 seconds max.

Note: These devices are not recommended for IR or Convection Reflow process.

Product Characteristics

Materials	Base/Cap: Brown Thermoplastic Polyamide PA 6.6, UL 94V-0 Round Pins: Copper, Tin-plated
Lead Pull Strength	10 N (EN 60068-2-21)
Solderability	260°C, ≤ 3s. (Wave) 350°C, ≤ 1s. (Soldering Iron)
Soldering Heat Resistance	260°C, 10s. (IEC 60068-2-20) 350°C, 3s. (Soldering Iron)

Operating Temperature	-40°C to +85°C (consider de-rating)
Climatic Category	-40°C to +85°C/21 days (EN 60068-1,-2-1,-2-2,-78)
Stock Conditions	+10 °C to +60 °C RH, ≤ 75% yearly average, without dew, maximum value for 30 days-95%
Vibration Resistance	24 cycles at 15 min. each (EN 60068-6) 10 - 60 Hz at 0.75 mm amplitude 60 - 2000 Hz at 10 g acceleration

Dimensions

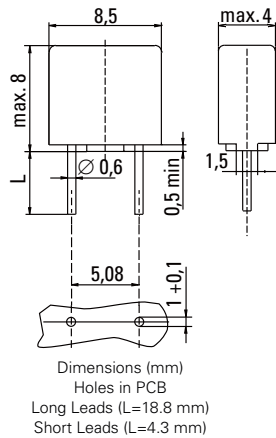

Part Numbering System

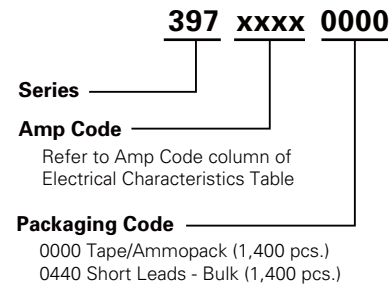

Packaging

Packaging Option	Packaging Specification	Quantity	Quantity & Packaging Code	Taping Width
397 Series				
Tape & Ammopack	N/A	1,400	0000	N/A
Short Leads	N/A	1,400	0440	N/A

397 Series

RoHS **Pb** **398 Series, TE5®, Modul Protector® Fuse**

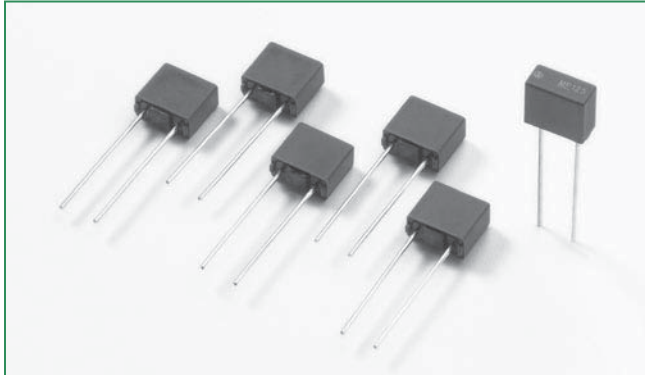

Description

The 398 Series are TE5® short circuit protector, medium time-lag type, 65V rated fuses.

Features

- Reduced PCB space requirements
- Highly defined cut-off times
- Low internal resistance
- Irreversible physical separation
- Flame resistant encapsulated casing
- Available from 125mA to 4A
- Halogen free

Applications

- Microprocessor protection

Agency Approvals

Agency	Agency File Number	Ampere Range
	E67006	125mA - 4A

Electrical Characteristics

% of Ampere Rating	Opening Time
300	10 Seconds, Max.

Electrical Characteristics

Amp Code	Rated Current	Marking Code*	Voltage Rating	Breaking Capacity	Cold Resistance 0.1 x I _N typ. (mΩ)	Power Dissipation 1.0 x I _N max. (mW)	Melting Integral 10 x I _N typ. (A ² s)	Agency Approvals
0125	125mA	MP13	65V	50A / 65 VAC/DC 50-60 Hz cosφ=1.0	900	50	0.0093	x
0250	250mA	MP25	65V		355	50	0.045	x
0315	315mA	MP32	65V		260	60	0.081	x
0400	400mA	MP40	65V		186	75	0.18	x
0500	500mA	MP50	65V		155	90	0.2	x
0630	630mA	MP63	65V		115	120	0.37	x
0800	800mA	MP80	65V		85	140	0.64	x
1100	1.00A	MP100	65V		65	170	1.1	x
1125	1.25A	MP125	65V		48	210	2.3	x
1160	1.60A	MP160	65V		34	320	4.5	x
1200	2.00A	MP200	65V		26	425	7.8	x
1250	2.50A	MP250	65V		21	550	13	x
1315	3.15A	MP315	65V		16	650	23	x
1400	4.00A	MP400	65V		12	1000	40	x

* Physical Marking on top of the device
Note: 1.00 means the number one with two decimal places. 1,000 means the number one thousand.

Temperature Derating Curve

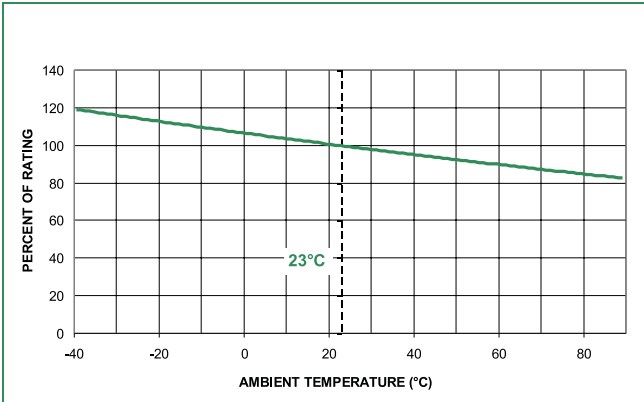

Average Time Current Curves

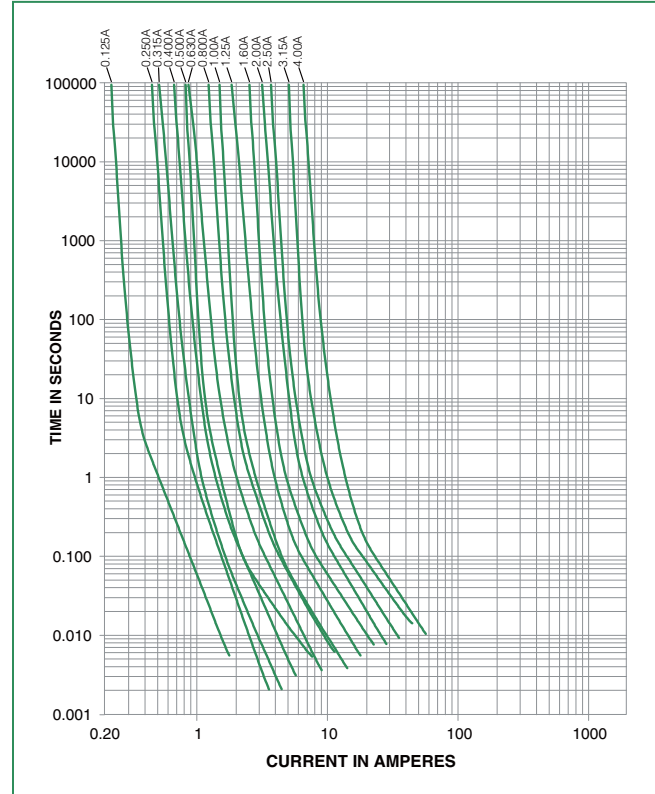

Soldering Parameters - Wave Soldering

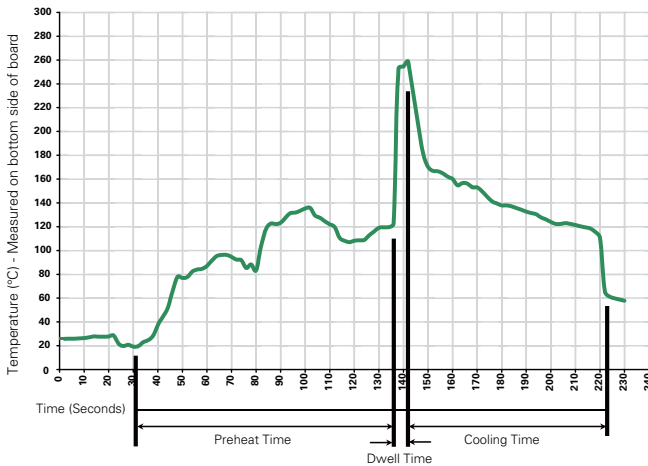

Recommended Process Parameters:

Wave Parameter	Lead-Free Recommendation
Preheat: (Depends on Flux Activation Temperature)	(Typical Industry Recommendation)
Temperature Minimum:	100° C
Temperature Maximum:	150° C
Preheat Time:	60-180 seconds
Solder Pot Temperature:	260° C Maximum
Solder Dwell Time:	2-5 seconds

Recommended Hand-Solder Parameters:

Solder Iron Temperature: 350° C +/- 5° C
Heating Time: 5 seconds max.

Note: These devices are not recommended for IR or Convection Reflow process.

Product Characteristics

Materials	Base/Cap: Brown Thermoplastic Polyamide PA 6.6, UL 94V-0 Round Pins: Copper, Tin-plated
Lead Pull Strength	10N (EN 60068-2-21)
Solderability	260°C, ≤ 3s. (Wave) 350°C, ≤ 1s. (Soldering Iron)
Soldering Heat Resistance	260°C, 10s. (IEC 60068-2-20) 350°C, 3s. (Soldering Iron)

Operating Temperature	-40°C to +85°C (consider de-rating)
Climatic Category	-40°C to +85°C/21 days (EN 60068-1,-2-1,-2-2,-78)
Stock Conditions	+10°C to +60°C RH, ≤ 75% yearly average, without dew, maximum value for 30 days-95%
Vibration Resistance	24 cycles at 15 min. each (EN 60068-6) 10 - 60 Hz at 0.75 mm amplitude 60 - 2000 Hz at 10 g acceleration

Dimensions

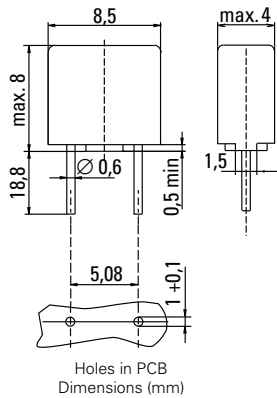

Part Numbering System

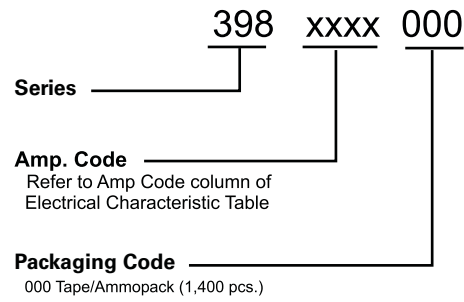

Packaging

Packaging Option	Packaging Specification	Quantity	Quantity & Packaging Code	Reel Size
398 Series				
Tape & Amp-pack	N/A	1,400	000	N/A

398 Series

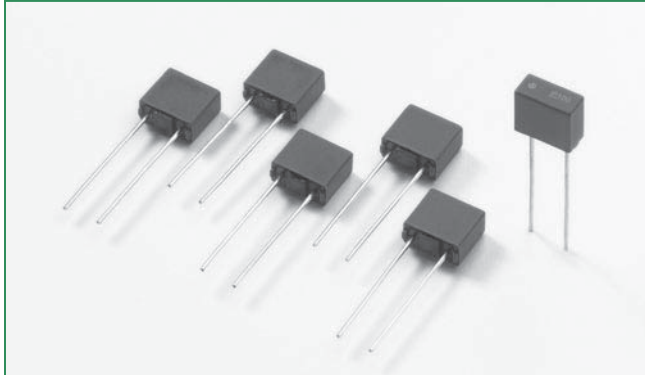

Description

The 399 Series are TE5®, time-Lag type, 65V rated fuses. For Short Circuit Protection of Sensitive Electronic Components and Assemblies.

Features

- Reduced PCB space requirements
- Highly defined cut-off times
- Low internal resistance
- Irreversible physical separation
- Flame resistant encapsulated casing
- Halogen free
- Available from 125mA to 4A

Applications

- IC Chip Protection

Electrical Characteristics

% of Ampere Rating	Opening Time
300	20 Seconds, Max.

Agency Approvals

Agency	Agency File Number	Ampere Range
cRU US	E67006	125mA - 4A

Electrical Characteristics

Amp Code	Rated Current	Marking Code*	Voltage Rating	Breaking Capacity	Cold Resistance 0.1 x I _N typ. (mΩ)	Power Dissipation 1.0 x I _N max. (mW)	Melting Integral 10 x I _N typ. (A ² s)	Agency Approvals cRU US
0125	125 mA	IP13	65 V	50A / 65 VAC/DC 50-60 Hz cosφ=1.0	1600	125	0.13	x
0160	160 mA	IP16	65 V		1100	140	0.2	x
0200	200 mA	IP20	65 V		775	155	0.29	x
0250	250 mA	IP25	65 V		550	170	0.42	x
0315	315 mA	IP32	65 V		330	190	0.62	x
0400	400 mA	IP40	65 V		265	220	0.92	x
0500	500 mA	IP50	65 V		190	240	1.4	x
0630	630 mA	IP63	65 V		130	265	2	x
0800	800 mA	IP80	65 V		92	300	3	x
1100	1.00 A	IP100	65 V		65	330	4.3	x
1125	1.25 A	IP125	65 V		47	370	6.5	x
1160	1.60 A	IP160	65 V		33	420	9.8	x
1200	2.00 A	IP200	65 V		23	460	14	x
1250	2.50 A	IP250	65 V		17	520	20	x
1315	3.15 A	IP315	65 V		13	580	40	x
1400	4.00 A	IP400	65 V		10	650	75	x

* Physical Marking on top of the device

Note: 1.00 means the number one with two decimal places. 1,000 means the number one thousand.

Temperature Derating Curve

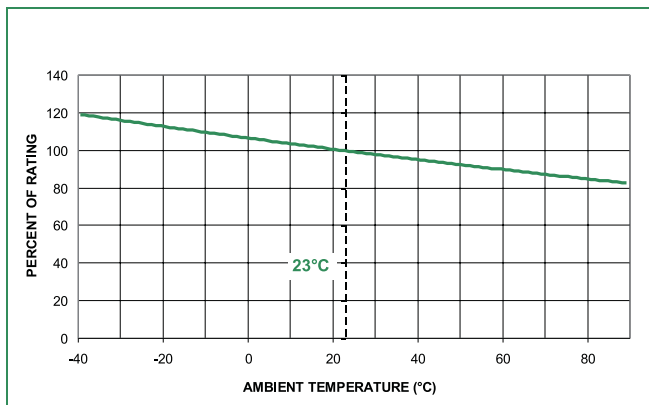

Average Time Current Curves

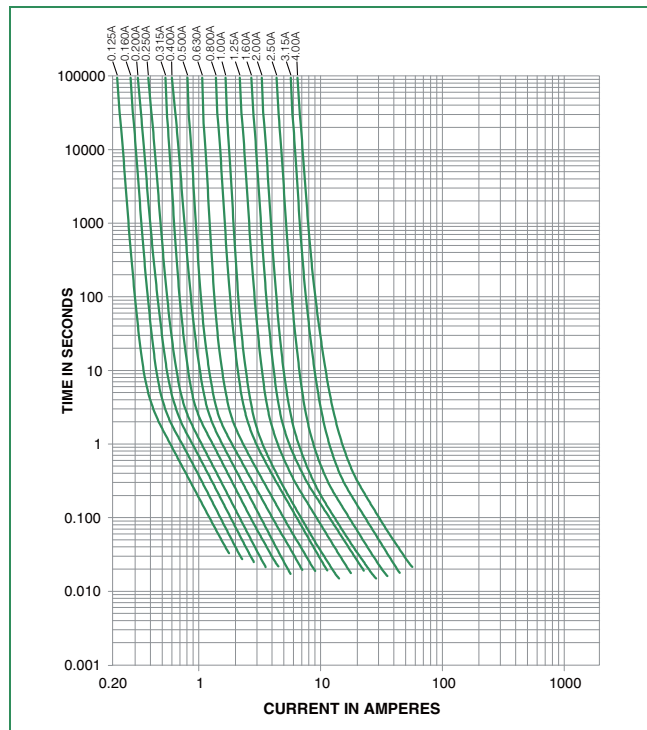

Soldering Parameters - Wave Soldering

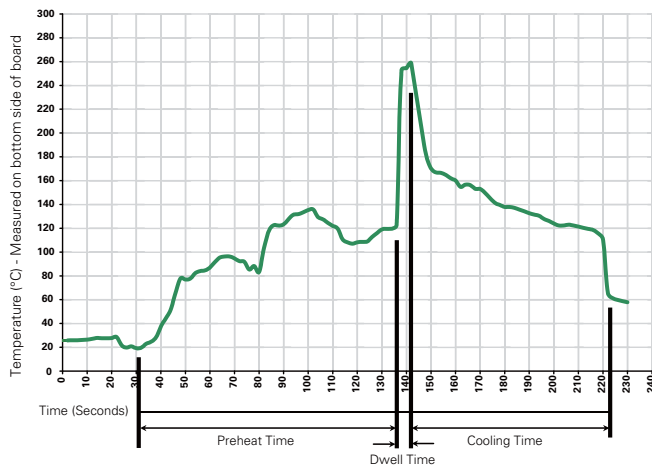

Recommended Process Parameters:

Wave Parameter	Lead-Free Recommendation
Preheat: (Depends on Flux Activation Temperature) (Typical Industry Recommendation)	
Temperature Minimum:	100° C
Temperature Maximum:	150° C
Preheat Time:	60-180 seconds
Solder Pot Temperature:	260° C Maximum
Solder Dwell Time:	2-5 seconds

Recommended Hand-Solder Parameters:

Solder Iron Temperature: 350° C +/- 5°C
 Heating Time: 5 seconds max.

Note: These devices are not recommended for IR or Convection Reflow process.

Product Characteristics

Materials	Base/Cap: Brown Thermoplastic Polyamide PA 6.6, UL 94V-0 Round Pins: Copper, Tin-plated
Lead Pull Strength	10 N (EN 60068-2-21)
Solderability	260°C, ≤ 3s. (Wave) 350°C, ≤ 1s. (Soldering Iron)
Soldering Heat Resistance	260°C, 10s. (IEC 60068-2-20) 350°C, 3s. (Soldering Iron)

Operating Temperature	-40°C to +85°C (consider de-rating)
Climatic Category	-40°C to +85°C/21 days (EN 60068-1,-2-1,-2-2,-78)
Stock Conditions	+10 °C to +60 °C RH, ≤ 75% yearly average, without dew, maximum value for 30 days-95%
Vibration Resistance	24 cycles at 15 min. each (EN 60068-6) 10 - 60 Hz at 0.75 mm amplitude 60 - 2000 Hz at 10 g acceleration

Dimensions

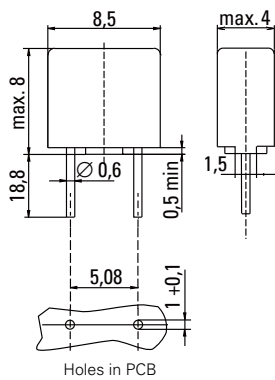

Part Numbering System

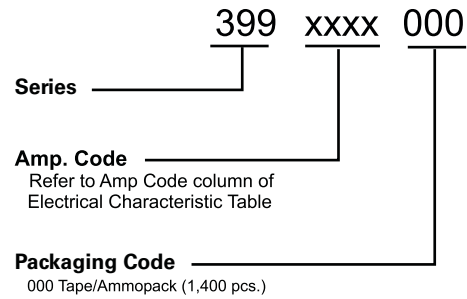

Packaging

Packaging Option	Packaging Specification	Quantity	Quantity & Packaging Code	Reel Size
399 Series				
Tape & Amp. pack	N/A	1,400	000	N/A

RoHS **HF 251/253 Series, PICO® II, Very Fast-Acting Fuse**

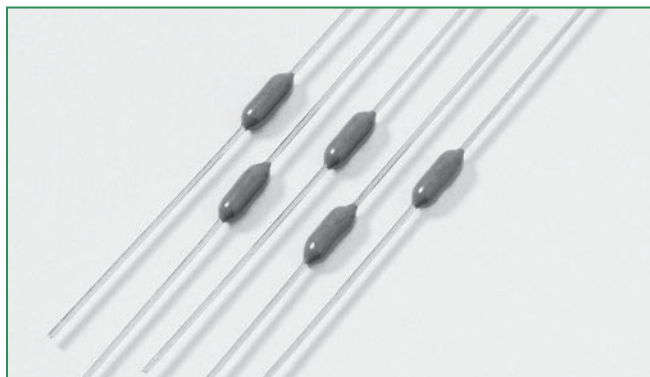

Description

The PICO® II Very Fast-Acting Fuse is designed to meet an extensive array of performance characteristics in a space-saving subminiature package.

Features





- Very fast-acting
- Small size
- Wide current rating range (62mA- 15A)
- RoHS compliant
- Halogen-free available
- Wide operating temperature range
- Low temperature derating

Applications

Secondary protection for space constrained applications

- Flat-panel display TV
- LCD monitor
- LCD backlight inverter
- Office machines
- Power supply
- Audio/Video system
- Lighting system
- Medical equipment





Agency Approvals

Agency	Agency File Number	Ampere Range
	E10480	62mA - 15A
	LR 29862	62mA - 15A
	JET 1896-31007-1001	1A - 5A
TUV	J50158379	500mA - 10A
QPL	FM10	62mA - 15A
	2009010207366577 – 500mA to 5A Pending – 7A, 10A	500mA, 1A, 2A, 2.5A, 3A, 4A, 5A, 7A, 10A

Electrical Characteristics for Series

% of Ampere Rating	Ampere Rating	Opening Time
100%	62mA - 15A	4 Hours, Min.
	62mA - 7A	1 Second, Max.
200%	10A	3 Seconds, Max.
	12 - 15A	10 Seconds, Max.
275%	500mA, 1A, 2A, 2.5A, 3A, 4A, 5A, 7A, 10A	300 msec., Max.
400%	500mA, 1A, 2A, 2.5A, 3A, 4A, 5A, 7A, 10A	30 msec., Max.
1000%	500mA, 1A, 2A, 2.5A, 3A, 4A, 5A, 7A, 10A	4 msec., Max.

Electrical Specifications by Item

Ampere Rating (A)	Amp Code	Ordering Number (Std.)	Ordering Number (Mil.)	Max Voltage Rating (V)	Interrupting Rating	Nominal Cold Resistance (Ohms)	Nominal Melting I ² t (A ² sec)	Nom Voltage Drop (V)	Agency Approvals						
												TUV	QPL		
.062	.062	251.062	253.062	125	300 A @ rated voltage DC	7.000	0.000113	1.4	x	x			x		
.125	.125	251.125	253.125	125		1.700	0.00174	0.285	x	x			x		
.250	.250	251.250	253.250	125		0.665	0.0116	0.24	x	x			x		
.375	.375	251.375	253.375	125		0.395	0.0296	0.215	x	x			x		
.500	.500	251.500	253.500	125		0.280	0.0598	0.2165	x	x		x	x	x	
.630	.630	251.630		125		0.205	0.094	0.188	x	x					
.750	.750	251.750	253.750	125		0.175	0.153	0.176	x	x		x	x		
1.00	001.	251001.	253001.	125		50 A @ rated voltage AC	0.128	0.256	0.194	x	x	x	x	x	x
1.25	1.25	2511.25		125			0.100	0.390	0.2	x	x	x			
1.50	01.5	25101.5	25301.5	125		For CCC 7A: 70 A @ rated voltage AC	0.0823	0.587	0.21	x	x	x	x	x	
2.00	002.	251002.	253002.	125			0.0473	0.405	0.141	x	x	x	x	x	x
2.50	02.5	25102.5		125			0.0360	0.721	0.132	x	x	x	x		x
3.00	003.	251003.	253003.	125		For CCC 10A: 100 A @ rated voltage AC	0.0290	1.19	0.131	x	x	x	x	x	x
3.50	03.5	25103.5		125			0.0240	1.58	0.1205	x	x	x	x		
4.00	004.	251004.	253004.	125			0.0204	2.45	0.114	x	x	x	x	x	x
5.00	005.	251005.	253005.	125	0.0155		4.14	0.11	x	x	x	x	x	x	
7.00	007.	251007.	253007.	125	0.0105		10.4	0.102	x	x		x	x	P	
10.0	010.	251010.	253010.	125	0.00705		25.5	0.1	x	x		x	x	P	
12.0	012.	251012.		32	0.0055	45.2	0.0878	x	x						
15.0	015.	251015.	253015.	32	0.00446	68.8	0.071	x	x			x			

Note: Higher ampere ratings are available. Please contact Littelfuse Technical Support or your Littelfuse products representative for assistance.

P = Pending

For Sand Filled-part 0242.050, please add "S" suffix in the part number

Temperature Derating Curve

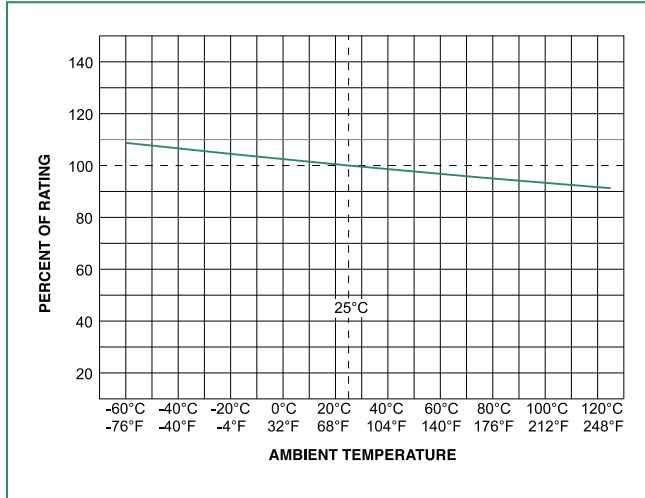

Note:

1. Derating depicted in this curve is in addition to the standard rating of 25% for continuous operation.

Soldering Parameters

Recommended Process Parameters:

Wave Parameter	Lead-Free Recommendation
Preheat: (Depends on Flux Activation Temperature)	(Typical Industry Recommendation)
Temperature Minimum:	100° C
Temperature Maximum:	150° C
Preheat Time:	60-180 seconds
Solder Pot Temperature:	260° C Maximum
Solder Dwell Time:	2-5 seconds

Recommended Hand-Solder Parameters:

Solder Iron Temperature: 350° C +/- 5° C
 Heating Time: 5 seconds max.

Note: These devices are not recommended for IR or Convection Reflow process.

Average Time Current Curves

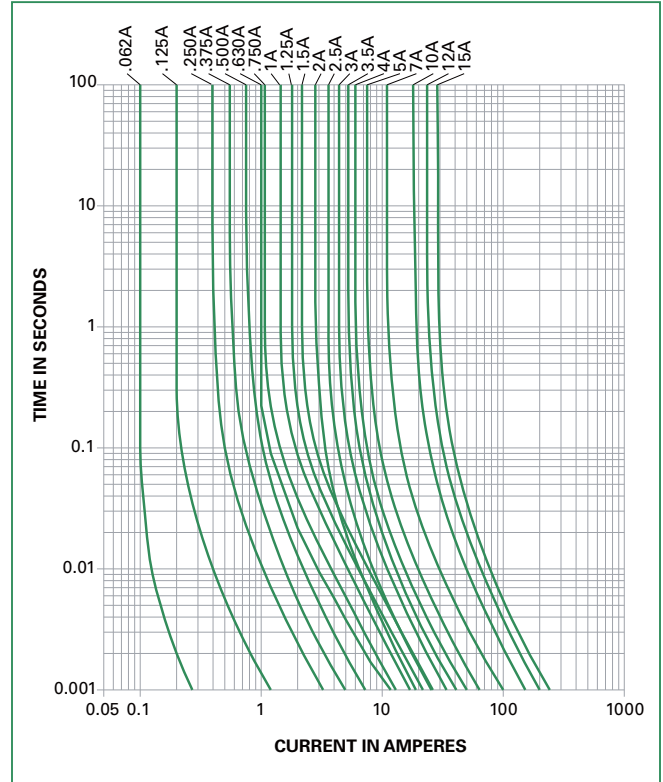

Product Characteristics

Materials	Encapsulated, Epoxy-Coated Body: Pure Tin-coated Copper wire leads
Solderability	MIL-STD-202, Method 208
Lead Pull Force	MIL-STD-202, Method 211, Test Condition A (will withstand a 7lbs. axial pull test)
Fuses To MIL SPEC	251/253 Series is available in FM10 on QPL for MIL-PRF-23419. To order, change 251 to 253

Operating Temperature	-55°C to +125°C
Shock	MIL-STD-202, Method 213, Test Condition I (100 G's peak for 6 msec.)
Vibration	MIL-STD-202, Method 201 (10–55 Hz); Method 204, Test Condition C (55–2000 Hz at 10 G's Peak)
Moisture Resistance	MIL-STD-202, Method 106
Resistance to Soldering Heat	Withstands 60 seconds above 200°C and up to 260°C, maximum
Flammability Rating	UL 94V-0

Dimensions

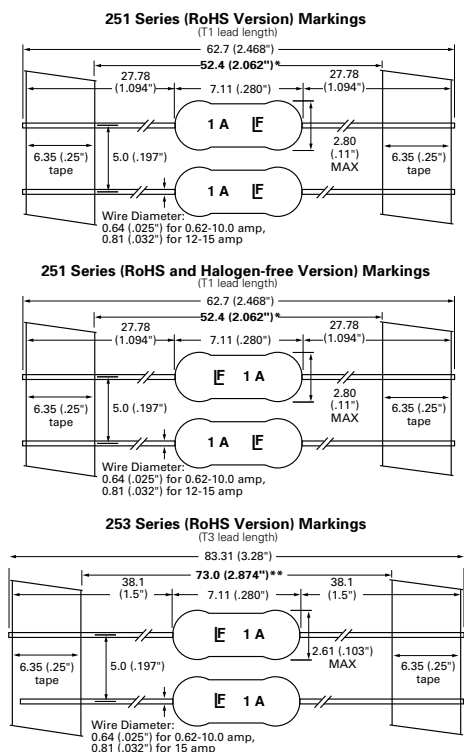

Part Numbering System

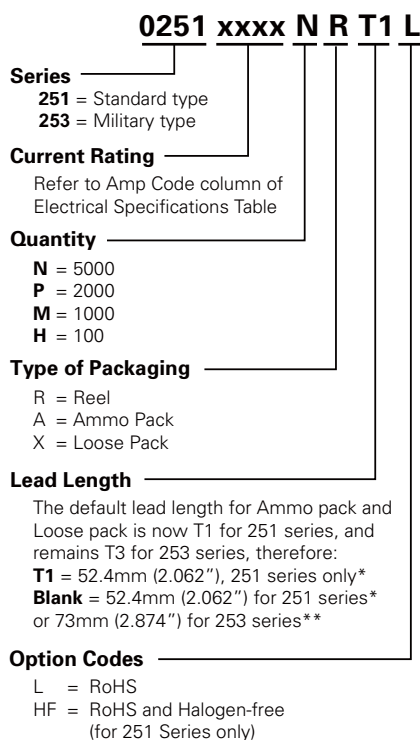

Packaging

Packaging Option	Packaging Specification	Quantity & Packaging Code
*T1: 52.4mm (2.062") Tape and Reel	EIA 296	Please refer to available quantities above in "Part Numbering System"
**T3: 73mm (2.874") Tape and Reel	EIA 296	

The default lead length for both ammo pack and loose pack is T1 for 251 and is T3 for 253.

Notes: * T1 dimension is defined as the length of the component between the two tapes. The full component length is 62.7mm (2.468"). **T1 length is for 251 series only.**
** T3 dimension is defined as the length of the component between the two tapes. The full component length is 83.37mm (3.28"). **T3 length is for 253 series only.**

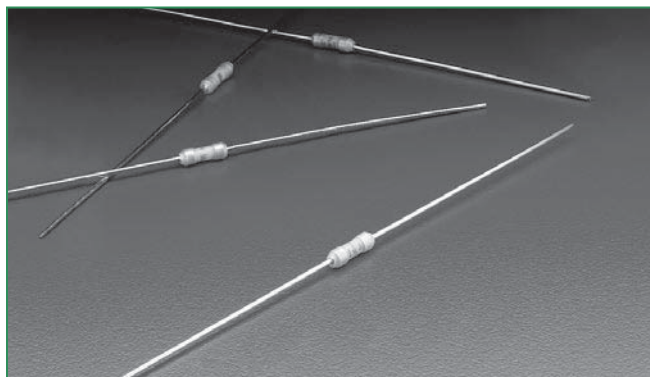
RoHS **275 Series, PICO®, Very Fast-Acting Fuse**

Description

The PICO® Very Fast-Acting Fuse is designed to meet an extensive array of performance characteristics in a space-saving subminiature package.

Features

- Very fast-acting
- Small size
- High current rating (20A- 30A)
- RoHS compliant
- Wide operating temperature range
- Low temperature de-rating

Applications

- Power supply
- PC server
- Networking equipment
- Storage system

Agency Approvals

Agency	Agency File Number	Ampere Range
	E10480	20A - 30A

Electrical Characteristics

% of Ampere Rating	Ampere Rating	Opening Time
100%	20 - 30	4 Hours, Min.
200%	20 - 30	10 Seconds, Max.

Electrical Characteristics

Ampere Rating (A)	Amp Code	Ordering Number	Max Voltage Rating (V)	Interrupting Rating	Nominal Cold Resistance (Ohms)	Nominal Melting I ² t (A ² sec)	Agency Approvals
							
20.0	020.	0275020.	32	300 amperes @ rated voltage VDC 100 amperes @ rated voltage VAC	0.0031	115	x
25.0	025.	0275025.	32		0.0026	192	x
30.0	030.	0275030.	32		0.0020	288	x

275 Series

Temperature Derating Curve

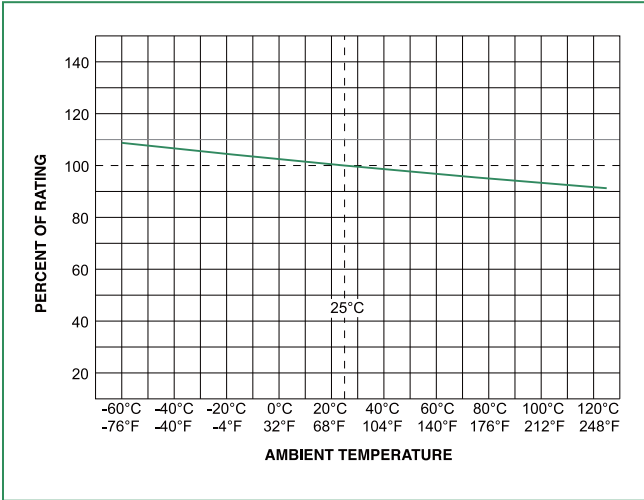

Note:
 1. Derating depicted in this curve is in addition to the standard derating of 25% for continuous operation.

Soldering Parameters

Recommended Process Parameters:

Wave Parameter	Lead-Free Recommendation
Preheat: (Depends on Flux Activation Temperature)	(Typical Industry Recommendation)
Temperature Minimum:	100° C
Temperature Maximum:	150° C
Preheat Time:	60-180 seconds
Solder Pot Temperature:	260° C Maximum
Solder Dwell Time:	2-5 seconds

Recommended Hand-Solder Parameters:

Solder Iron Temperature: 350° C +/- 5° C
 Heating Time: 5 seconds max.

Note: These devices are not recommended for IR or Convection Reflow process.

Average Time Current Curves

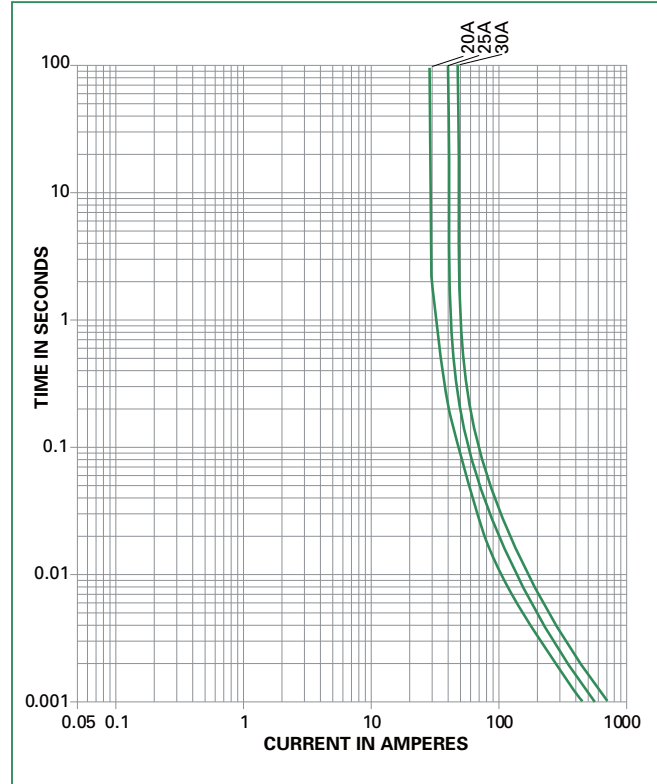

Product Characteristics

Materials	Transparent sleeve covered body, Pure Tin-coated copper wire leads
Solderability	MIL-STD-202, Method 208
Lead Pull Force	MIL-STD-202, Method 211, Test Condition A (will withstand a 5lbs. axial pull test)

Operating Temperature	-55°C to +125°C
Shock	MIL-STD-202, Method 213, Test Condition I (100 G's peak for 6 milliseconds) and per method 2028 (78G's peak for 11 milliseconds)
Vibration	MIL-STD-202, Method 201 (10-55 Hz); Method 204, Test Condition D (Vibrations of 10-2000 cps at 20 G's)
Moisture Resistance	MIL-STD-202, Method 106

Dimensions

275 000 Series

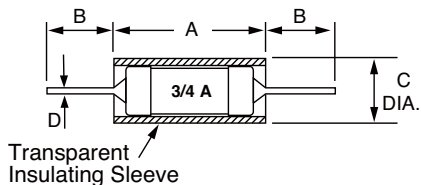

Amperage	Dimensions in mm (inches)			
	A	B	C	D
20 - 30	7.87 (.31")	27.78 (1.094")	3.38 (.133")	1.016 (.040")

Part Numbering System

0275 xxxx M R T1 L

Series	0275
Current Rating	xxxx Refer to Amp Code column of Electrical Characteristics Table
Quantity	M = 1000 V = 5
Type of Packaging	R = Reel X = Loose Pack
Lead Length	T1 = 52.4mm (2.062") Blank = For Loose pack (MXL,VXL)
RoHS	Only RoHS parts are available for 275 Series

Packaging

Packaging Option	Packaging Specification	Quantity & Packaging Code
T1: 52.4mm (2.062") Tape and Reel	EIA 296	Please refer to available quantities above in "Part Numbering System"

The default lead length for loose pack is T1.

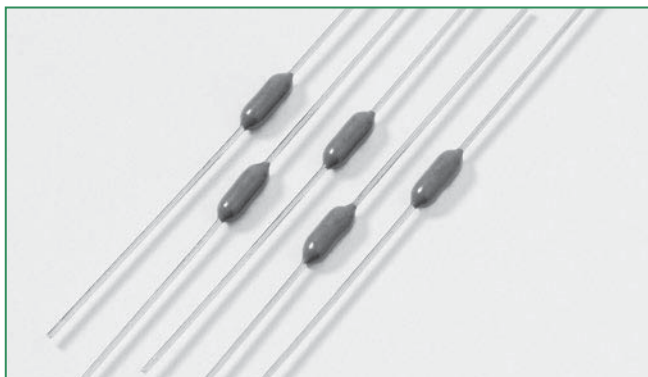
RoHS HF 263 Series, PICO® II 250 Volt, Very Fast-Acting Fuse

Description

The PICO® II 263 Series Fuse is a specially designed axial leaded fuse that achieves a 250V rating in a small package.

Features

- 250V rating
- Very fast-acting
- Small size
- Wide range of current rating available (62mA to 5A)
- RoHS compliant & Halogen-free
- Wide operating temperature range
- Low temperature de-rating



Applications

- Lighting system
- Power supply
- LCD/PDP TV
- LCD monitor
- Office automation machines
- Audio/Video system
- Medical equipment



Electrical Characteristics

% of Ampere Rating	Opening Time
100%	4 Hours, Min.
200%	1 Second, Max.
300%	0.1 Second, Max.

Agency Approvals

Agency	Agency File Number	Ampere Range
	E10480	62mA - 5A
	JET 1896-31007-1001	1A - 5A
	LR 29862	125mA - 5A

Electrical Characteristics

Ampere Rating (A)	Amp Code	Max Voltage Rating (V)	Interrupting Rating	Nominal Cold Resistance (Ohms)	Nominal Melting I ² t (A ² sec)	Nom Voltage Drop (mV)	Agency Approvals		
									
0.062	.062	250	50 amperes at 250 VAC PSE: 100 amperes at 125 VAC.	5.50	0.000192	0.74	x		
0.125	.125	250		1.75	0.00251	0.3	x		x
0.250	.250	250		0.715	0.0165	0.235	x		x
0.375	.375	250		0.391	0.0444	0.195	x		x
0.500	.500	250		0.332	0.084	0.302	x		x
0.750	.750	250		0.150	0.0411	0.176	x		x
1.00	001.	250		0.105	0.087	0.165	x	x	x
1.50	01.5	250		0.0635	0.398	0.148	x	x	x
2.00	002.	250		0.0444	0.74	0.137	x	x	x
2.50	02.5	250		0.0340	1.197	0.128	x	x	x
3.00	003.	250		0.0274	1.77	0.1225	x	x	x
3.50	03.5	250		0.0224	2.33	0.1175	x	x	x
4.00	004.	250		0.0193	3.08	0.1125	x	x	x
5.00	005.	250		0.0145	5.55	0.1065	x	x	x

Temperature Derating Curve

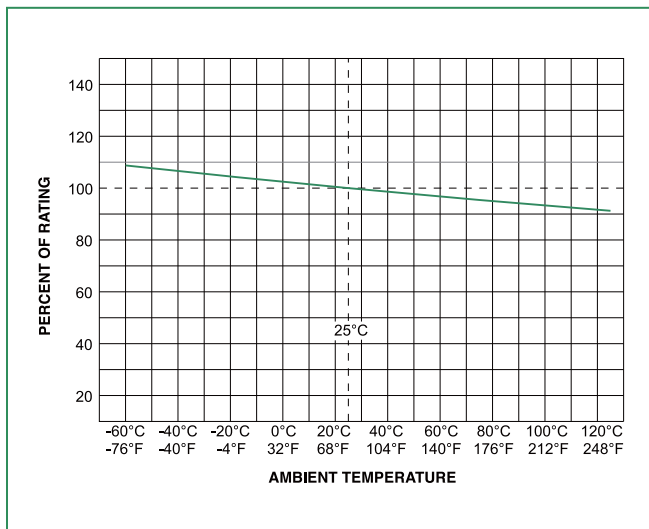

Note:
1. Derating depicted in this curve is in addition to the standard derating of 25% for continuous operation.

Average Time Current Curves

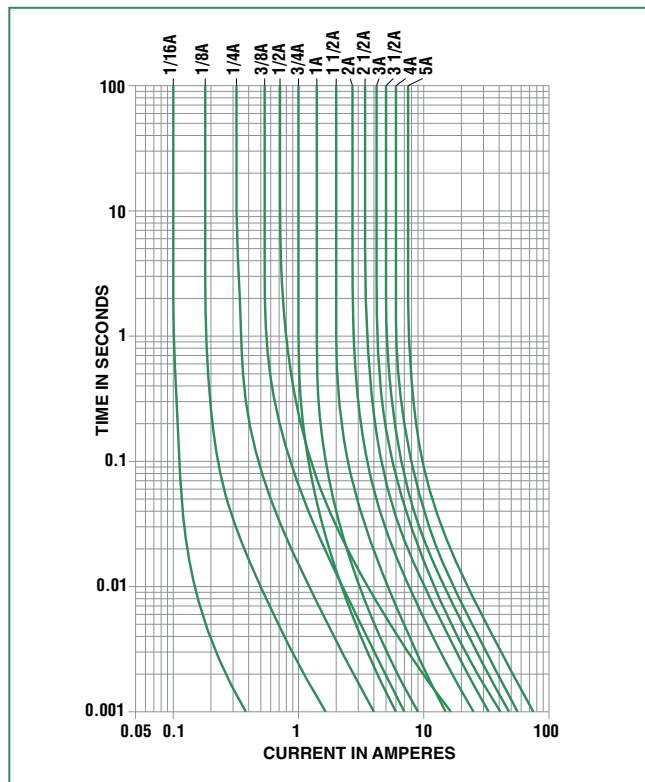

Soldering Parameters

Recommended Process Parameters:

Wave Parameter	Lead-Free Recommendation
Preheat: (Depends on Flux Activation Temperature)	(Typical Industry Recommendation)
Temperature Minimum:	100° C
Temperature Maximum:	150° C
Preheat Time:	60-180 seconds
Solder Pot Temperature:	260° C Maximum
Solder Dwell Time:	2-5 seconds

Recommended Hand-Solder Parameters:

Solder Iron Temperature: 350° C +/- 5° C
Heating Time: 5 seconds max.

Note: These devices are not recommended for IR or Convection Reflow process.

Product Characteristics

Materials	Encapsulated, Epoxy-Coated Body: Solder Coated Copper Leads. RoHS compliant Product: Pure Tin-coated Copper wire leads
Solderability	MIL-STD-202, Method 208.
Product Marking	Body marking, current rating and logo
Operating Temperature	-55°C to +125°C
Shock	MIL-STD-202, Method 213, Test Condition I (100 G's peak for 6 milliseconds)

Vibration	MIL-STD-202, Method 201 (10–55 Hz); MIL-STD-202, Method 204, Test Condition C (55–2000 Hz at 10 G's Peak)
Salt Spray	MIL-STD-202, Method 101, Test Condition B (48 hrs.)
Insulation Resistance (After Opening):	MIL-STD-202, Method 302, Test Condition A (10,000 ohms minimum at 100 volts)
Resistance to Soldering Heat	MIL-STD-202, Method 210, Test Condition C (10 sec. at 260°C)
Thermal Shock	MIL-STD-202, Method 107, Test Condition B (-55°C to 125°C)
Moisture Resistance	MIL-STD-202, Method 106
Lead Pull Force	MIL-STD-202, Method 211, Test Condition A (will withstand 7 lb. axial pull test)

Dimensions

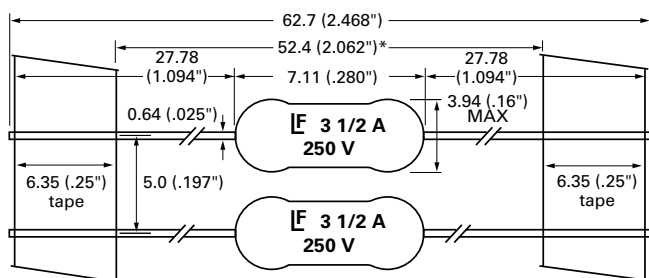

Part Numbering System

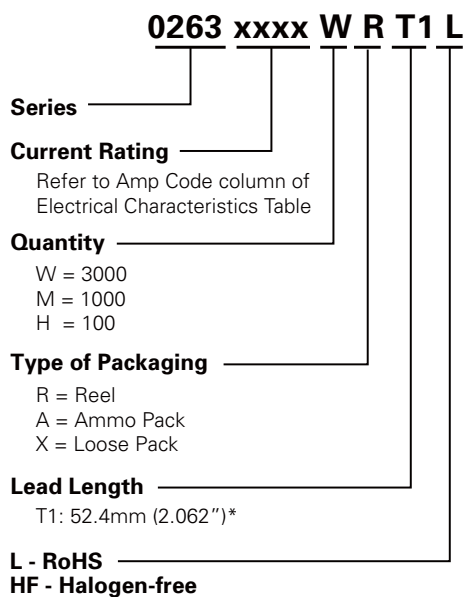

Packaging

Packaging Option	Packaging Specification	Quantity	Quantity & Packaging Code
T1: 52.4mm (2.062") Tape and Reel	EIA 296		Please refer to available quantities above in "Part Numbering System"

Notes: * T1 dimension is defined as the length of the component between the two tapes. The full component length is 62.7mm (2.468").

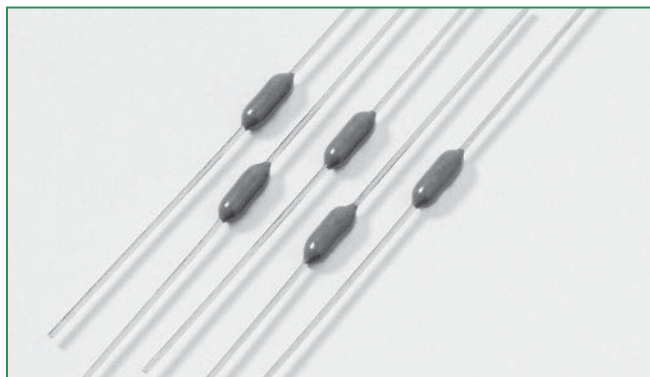
RoHS HF 471 Series, PICO® II, Time-Lag Fuse

Description

The 471 Series PICO® II Time-Lag Fuse is designed for applications that require moderate in-rush withstand and is in a space-saving subminiature package.

Features

- Moderate in-rush withstand
- Small size
- Wide range of current ratings available (500mA to 5A)
- RoHS compliant
- Halogen-free available
- Wide operating temperature range
- Low temperature de-rating



Applications

- Flat-panel display TV
- LCD monitor
- Lighting system
- Medical equipment
- Industrial equipment



Electrical Characteristics

% of Ampere Rating	Opening Time
100%	4 Hours, Min.
200%	120 Seconds, Max.

Agency Approvals

Agency	Agency File Number	Ampere Range
	E10480	500mA - 5A
	LR 29862	500mA - 2.5A
	JET 1896-31007-1001	1A - 5A

Electrical Characteristics

Ampere Rating (A)	Amp Code	Max Voltage Rating (V)	Interrupting Rating	Nominal Cold Resistance (Ohms)	Nominal Melting I ² t (A ² sec)	Nom Voltage Drop (mV)	Agency Approvals		
									
.500	.500	125	50 amperes at 125 VAC and VDC	0.189	0.159		X	X	
1.00	001.	125		0.085	0.722		X	X	X
1.50	01.5	125		0.054	1.610		X	X	X
2.00	002.	125		0.039	2.500		X	X	X
2.50	02.5	125		0.030	4.390		X	X	X
3.00	003.	125		0.023	6.960		X		X
4.00	004.	125		0.012	10.600		X		X
5.00	005.	125		0.008	15.400		X		X

Temperature Derating Curve

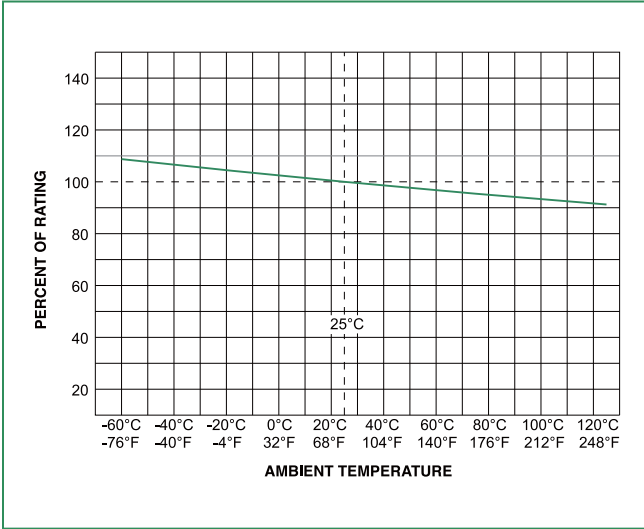

Note:
 1. Derating depicted in this curve is in addition to the standard derating of 25% for continuous operation.

Average Time Current Curves

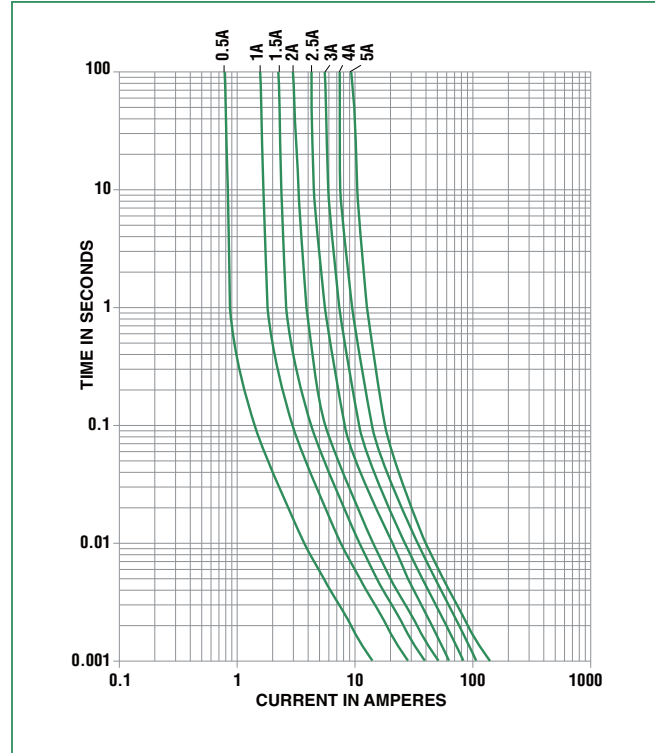

Soldering Parameters

Recommended Process Parameters:

Wave Parameter	Lead-Free Recommendation
Preheat: (Depends on Flux Activation Temperature)	(Typical Industry Recommendation)
Temperature Minimum:	100° C
Temperature Maximum:	150° C
Preheat Time:	60-180 seconds
Solder Pot Temperature:	260° C Maximum
Solder Dwell Time:	2-5 seconds

Recommended Hand-Solder Parameters:

Solder Iron Temperature: 350° C +/- 5° C
 Heating Time: 5 seconds max.

Note: These devices are not recommended for IR or Convection Reflow process.

Product Characteristics

Materials	Encapsulated, Epoxy-Coated Body; Solder Coated Copper wire leads; RoHS compliant Product: Pure Tin-coated Copper wire leads
Flammability Rating	UL 94V-0
Solderability	MIL-STD-202, Method 208
Lead Pull Force	MIL-STD-202, Method 211, Test Condition A (will withstand a 7 lbs. axial pull test)

Operating Temperature	-55°C to +125°C
Shock	MIL-STD-202, Method 213, Test Condition I (100 G's peak for 6 milliseconds)
Vibration	MIL-STD-202, Method 201 (10-55 Hz); Method 204, Test Condition C (55-2000 Hz at 10 G's Peak)
Moisture Resistance	MIL-STD-202, Method 106
Resistance to Soldering Heat	Withstands 60 seconds above 200°C and up to 260°C, maximum

Dimensions

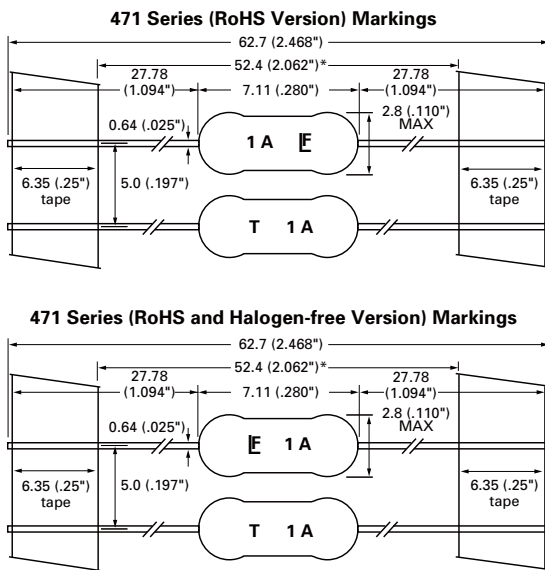

Part Numbering System

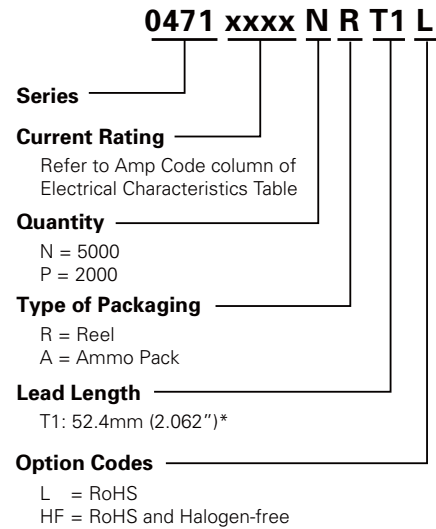

Packaging

Packaging Option	Packaging Specification	Quantity & Packaging Code
*T1: 52.4mm (2.062") Tape and Reel	EIA 296	Please refer to available quantities above in "Part Numbering System"

Notes: * T1 dimension is defined as the length of the component between the two tapes. The full component length is 62.7mm (2.468").

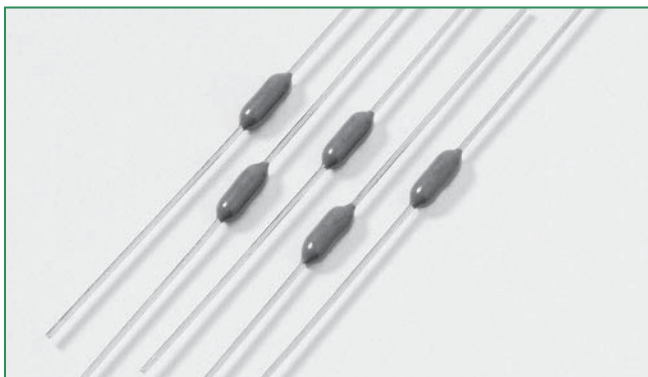
RoHS **472 Series, PICO® II, Time-Lag Fuse**

Description

The 472 Series PICO® II, 125V rated time-Lag fuse is designed for applications that require moderate in-rush withstand and is in a space-saving subminiature package.

Features

- Moderate in-rush withstand
- Small size
- Wide range of current ratings available (500mA to 5A)
- RoHS compliant
- Wide operating temperature range
- Low temperature de-rating

Applications

- Flat-panel display TV
- Lighting
- Game Console
- Power Supply
- Audio/Video Equipment

Agency Approvals

Agency	Agency File Number	Ampere Range
	E10480	500mA - 5A

Electrical Characteristics

% of Ampere Rating	Opening Time
100%	4 Hours, Min.
200%	120 Seconds, Max.

Electrical Characteristics

Ampere Rating (A)	Amp Code	Max Voltage Rating (V)	Interrupting Rating	Nominal Cold Resistance (Ohms)	Nominal Melting I ² t (A ² sec)	Agency Approvals 
.500	.500	125	50 amperes at 125 VAC and VDC	0.174	0.1927	x
1.00	001.	125		0.078	0.9384	x
1.50	01.5	125		0.039	2.4081	x
2.00	002.	125		0.027	4.2363	x
2.50	02.5	125		0.0209	7.0838	x
3.00	003.	125		0.0187	9.3600	x
5.00	005.	125		0.0084	45.9000	x

472 Series

Temperature Derating Curve

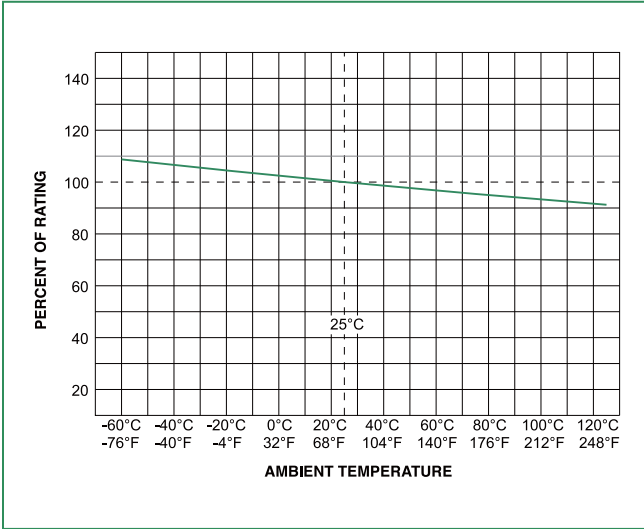

Note:
1. Derating depicted in this curve is in addition to the standard derating of 25% for continuous operation.

Average Time Current Curves

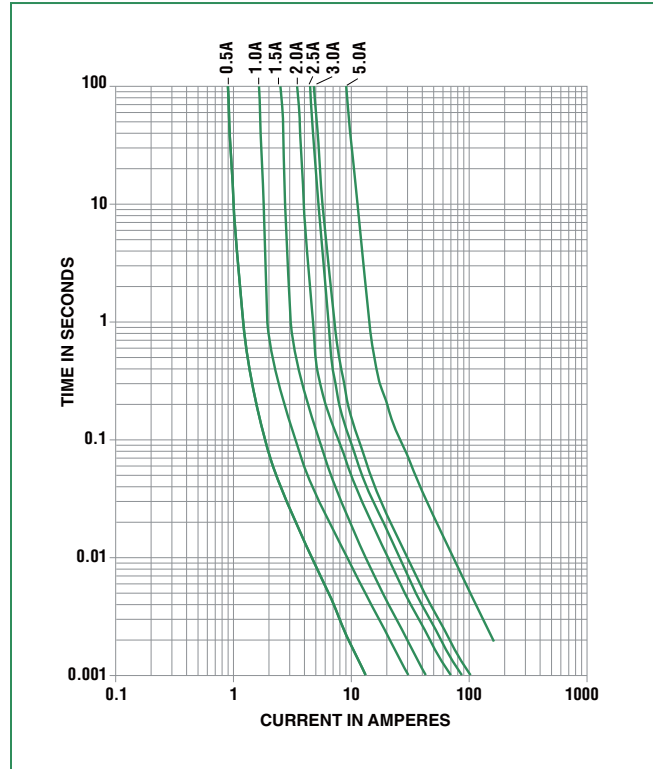

Soldering Parameters

Recommended Process Parameters:

Wave Parameter	Lead-Free Recommendation
Preheat: (Depends on Flux Activation Temperature)	(Typical Industry Recommendation)
Temperature Minimum:	100° C
Temperature Maximum:	150° C
Preheat Time:	60-180 seconds
Solder Pot Temperature:	260° C Maximum
Solder Dwell Time:	2-5 seconds

Recommended Hand-Solder Parameters:

Solder Iron Temperature: 350° C +/- 5° C
Heating Time: 5 seconds max.

Note: These devices are not recommended for IR or Convection Reflow process.

Product Characteristics

Material	Body: Ceramic Leads: Tin-coated Copper Encapsulated: Epoxy-Coated Body
Product Marking	Body: Brand Logo, Current Rating, T (time Lag fuse)
Solderability	MIL-STD-202, Method 208
Lead Pull Force	MIL-STD-202, Method 211, Test Condition A (will Withstand a 7lbs. Axial pull test)

Operating Temperature	-55°C to +125°C with proper de-rating
Thermal Shock	MIL-STD-202, Method 213, Test Condition I (100 G's peak for 6 milliseconds)
Vibration	MIL-STD-202, Method 201 (10-55 Hz); Method 204, Test Condition C (55-2000 Hz at 10 G's Peak)

Dimensions

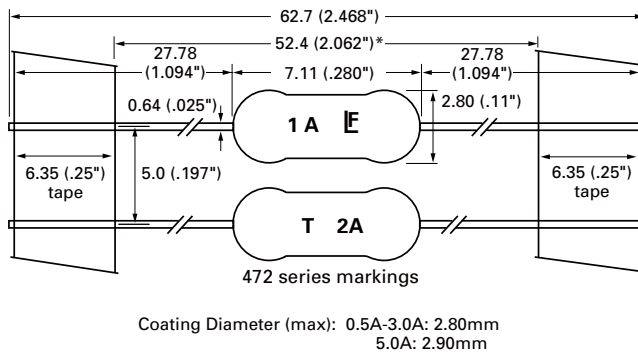

Part Numbering System

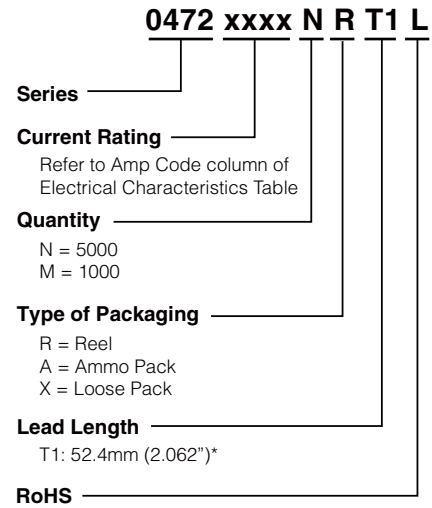

Packaging

Packaging Option	Packaging Specification	Quantity	Quantity & Packaging Code
*T1: 52.4mm (2.062") Tape and Reel	EIA 296		Refer to the tables in Part Numbering System above

Notes: * T1 dimension is defined as the length of the component between the two tapes. The full component length is 62.7mm (2.468").

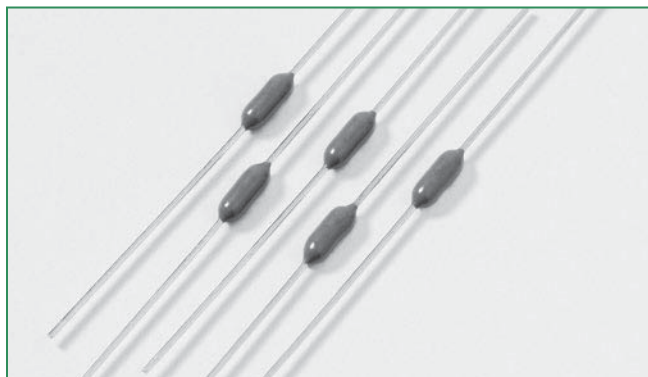
RoHS 473 Series, PICO® II, Slo-Blo® Fuse

Description

The PICO® II Slo-Blo® Fuse combines time-delay performance characteristics with the proven reliability of a PICO® Fuse.



Features

- Enhanced inrush withstand
- Small size
- Wide range of current ratings (375mA - 7A)
- RoHS compliant
- Wide operating temperature range
- Low temperature de-rating

Applications

- Flat-panel Display TV
- LCD monitor
- Lighting system
- Medical equipment
- Industrial equipment



Agency Approvals

Agency	Agency File Number	Ampere Range
	E10480	375mA - 7A
	LR 29862	375mA - 7A
	JET 1896-31007-1001	1A - 5A

Electrical Characteristics

% of Ampere Rating	Opening Time
100%	4 Hours, Min.
200%	1 Sec., Min. ; 60 Sec., Max.
300%	0.2 Sec., Min. ; 3 Sec., Max.
800%	0.02 Sec., Min. ; 0.1 Sec., Max.

Electrical Characteristics

Ampere Rating (A)	Amp Code	Max Voltage Rating (V)	Interrupting Rating	Nominal Cold Resistance (Ohms)	Nominal Melting I ² t (A ² sec)	Nom Voltage Drop (mV)	Agency Approvals		
									
0.375	.375	125	50 amperes at 125 VDC/ VAC	1.7400	0.085	0.840	X	X	
0.500	.500	125		1.1300	0.210	0.775	X	X	
0.750	.750	125		0.4600	0.760	0.429	X	X	
1.00	001.	125		0.2670	2.010	0.353	X	X	X
1.50	01.5	125		0.1160	3.940	0.208	X	X	X
2.00	002.	125		0.0712	7.600	0.180	X	X	X
2.25	2.25	125		0.0630	9.280	0.164	X	X	X
2.50	02.5	125		0.0520	13.00	0.153	X	X	X
3.00	003.	125		0.0380	21.00	0.140	X	X	X
3.50	03.5	125		0.0240	26.80	0.094	X	X	X
4.00	004.	125		0.0194	35.00	0.086	X	X	X
5.00	005.	125		0.0133	54.80	0.074	X	X	X
7.00	007.	125		0.0092	105.00	0.070	X	X	

Temperature Derating Curve

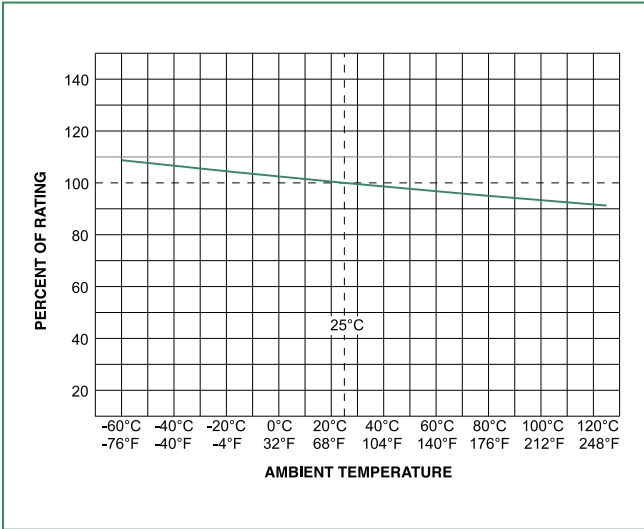

Note:
 1. Derating depicted in this curve is in addition to the standard derating of 25% for continuous operation.

Soldering Parameters

Recommended Process Parameters:

Wave Parameter	Lead-Free Recommendation
Preheat: (Depends on Flux Activation Temperature)	(Typical Industry Recommendation)
Temperature Minimum:	100° C
Temperature Maximum:	150° C
Preheat Time:	60-180 seconds
Solder Pot Temperature:	260° C Maximum
Solder Dwell Time:	2-5 seconds

Recommended Hand-Solder Parameters:

Solder Iron Temperature: 350° C +/- 5° C
 Heating Time: 5 seconds max.

Note: These devices are not recommended for IR or Convection Reflow process.

Average Time Current Curves

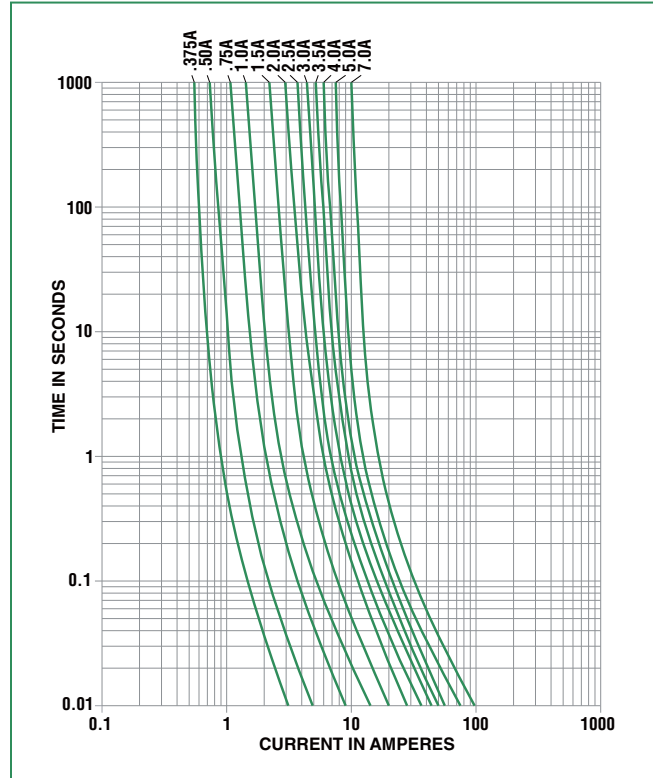

Product Characteristics

Materials	Encapsulated, Epoxy-Coated Body; Solder Coated Copper wire leads; RoHS compliant Product: Pure Tin-coated Copper wire leads
Solderability	MIL-STD-202, Method 208
Lead Pull Force	MIL-STD-202, Method 211, Test Condition A (will withstand 7 lbs. axial pull test)
Operating Temperature	-55°C to +125°C
Shock	MIL-STD-202, Method 213, Test Condition I (100 G's peak for 6 milliseconds)

Vibration	MIL-STD-202, Method 201 (10–55 Hz); MIL-STD-202, Method 204, Test Condition C (55–2000 Hz at 10 G's Peak)
Salt Spray	MIL-STD-202, Method 101, Test Condition B
Insulation Resistance (After Opening):	MIL-STD-202, Method 302, (10,000 ohms minimum at 100 volts)
Resistance to Soldering Heat	MIL-STD-202, Method 210, Test Condition C (20 sec at 260°C)
Thermal Shock	MIL-STD-202, Method 107, Test Condition B (-65°C to 125°C)
Moisture Resistance	MIL-STD-202, Method 106 (90–98% RH), Heat (65°C)

Dimensions

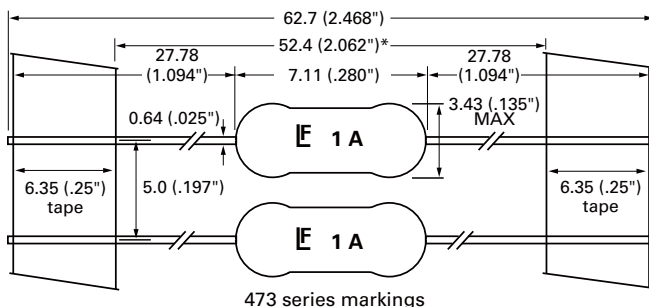

Part Numbering System

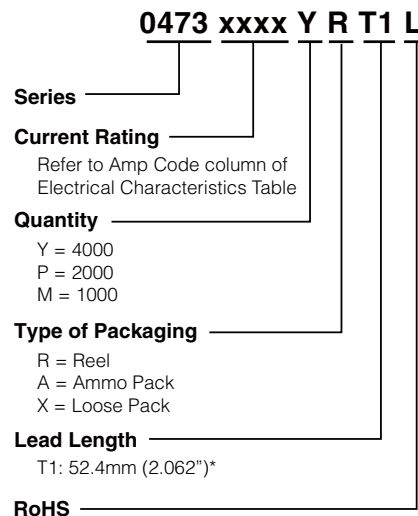

Packaging

Packaging Option	Packaging Specification	Quantity & Packaging Code
*T1: 52.4mm (2.062") Tape and Reel	EIA 296	Please refer to available quantities above in "Part Numbering System"

Notes: * T1 dimension is defined as the length of the component between the two tapes. The full component length is 62.7mm (2.468").



265/266/267 Series, PICO®, Very Fast-Acting Fuse (High-Reliability)

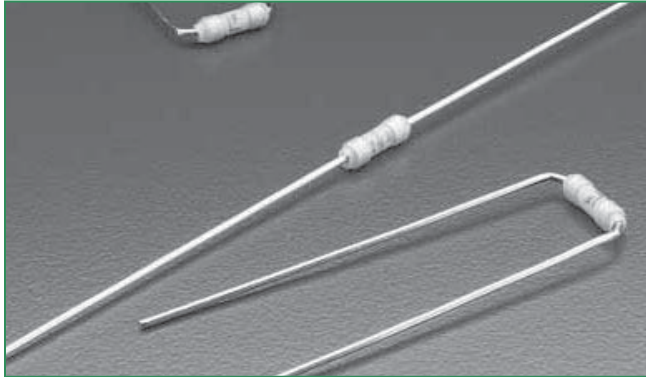

Description

The 265/266/267 Series are high-reliability PICO® Fuses, that are very fast-acting, with an insulating sleeve. These fuses provide supplemental protection in end-use equipment to provide protection for components or internal circuits. They are not suitable for branch or feeder circuit use. The Military version of the 265 Series (except 1/16 ampere rating) is available in FM08A on QPL for MIL-PRF-23419/8. To order, change 265 to 267.

Features

- Military grade available
- Available in axial and radial leaded
- RoHS compliant
- Available from 62mA to 15A
- Available in miniature and subminiature formats

Agency Approvals

Agency	Agency File Number	Ampere Range
	E10480	062mA - 15A
	LR 29862	062mA - 10A
	FM08A	062mA - 10A

Electrical Characteristics

% of Ampere Rating	Ampere Rating	Opening Time
100%	1/16–15	4 Hours, Min.
200%	1/16–7	1 Second, Max.
	10	3 Second, Max.
	15	10 Second, Max.

Electrical Characteristics

Ampere Rating (A)	Amp Code	Max Voltage Rating (V)	Interrupting Rating	Nominal Cold Resistance (Ohms)	Agency Approvals		
0.062	.062	125	300 amperes at rated voltage V_{DC} 50 amperes at rated voltage V_{AC}	7.0000	X	X	X
0.125	.125	125		2.1000	X	X	X
0.250	.250	125		0.7100	X	X	X
0.375	.375	125		0.4200	X	X	X
0.500	.500	125		0.2800	X	X	X
0.750	.750	125		0.1700	X	X	X
1.00	001.	125		0.1250	X	X	X
1.50	01.5	125		0.0800	X	X	X
2.00	002.	125		0.0550	X	X	X
2.50	02.5	125		0.0420	X	X	X
3.00	003.	125		0.03515	X	X	X
4.00	004.	125		0.0230	X	X	X
5.00	005.	125		0.0140	X	X	X
7.00	007.	125		0.0100	X	X	X
10.0	010.	125		0.00645	X	X	X
15.0	015.	32		0.0040	X	X	X

265/266/267

Temperature Derating Curve

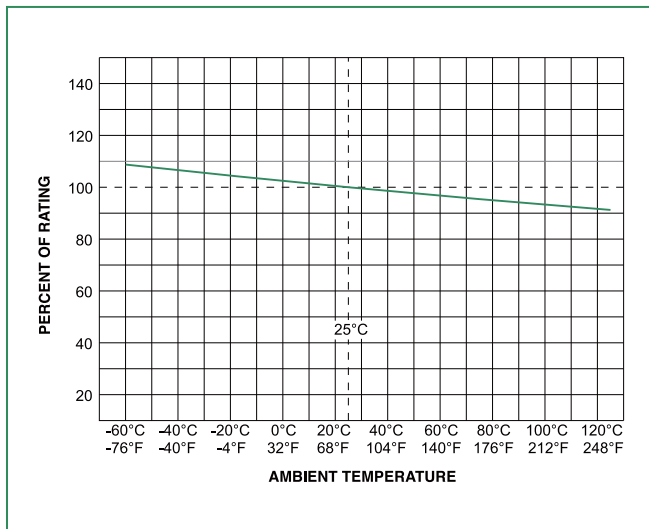

Note:
 1. Derating depicted in this curve is in addition to the standard derating of 25% for continuous operation.

Average Time Current Curves

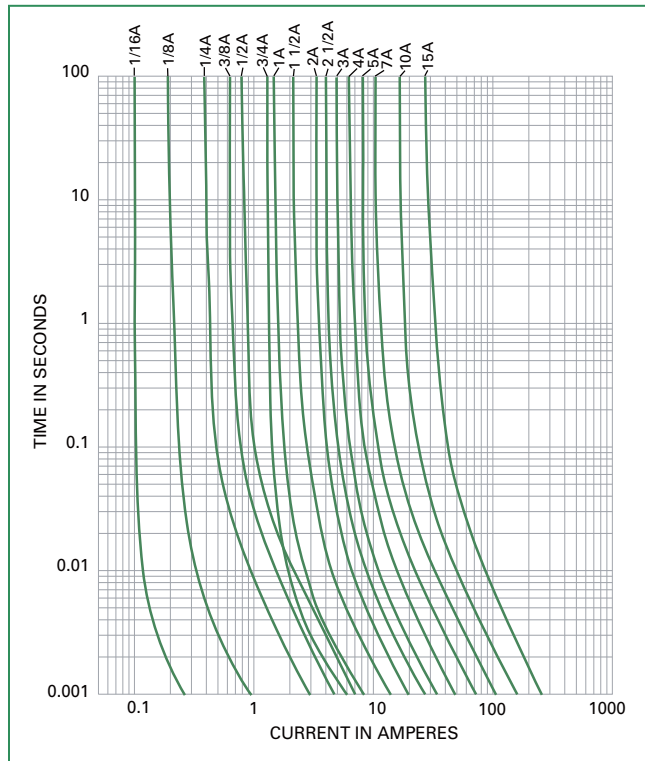

Soldering Parameters

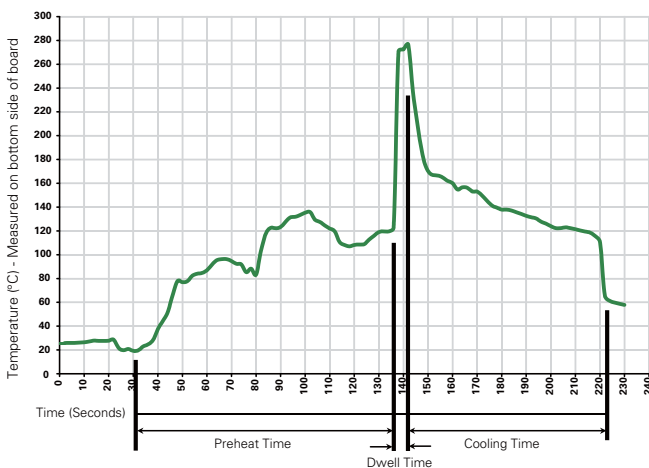

Recommended Process Parameters:

Wave Parameter	Lead-Free Recommendation
Preheat: (Depends on Flux Activation Temperature)	(Typical Industry Recommendation)
Temperature Minimum:	100° C
Temperature Maximum:	150° C
Preheat Time:	60-180 seconds
Solder Pot Temperature:	280° C Maximum
Solder Dwell Time:	2-5 seconds

Recommended Hand-Solder Parameters:

Solder Iron Temperature: 350° C +/- 5° C
 Heating Time: 5 seconds max.

Note: These devices are not recommended for IR or Convection Reflow process.

Product Characteristics

Materials	Body: White Thermoplastic Gold-Plated Copper Leads, Type II
Weight	.32 Grams
Solderability	MIL-STD-202, Method 208
Lead Pull Force	MIL-STD-202, Method 211, Test Condition A (will withstand a 5 lbs. axial pull test) AQL (Electrical Characteristics): Certified to 1% AQL
Sampling	Per MIL-STD-105, Inspection Level II. Traceability and Identification Records: Controlled by lot number and retained on file for a minimum of three years. Copies of Lot Certification Test data available when requested with order
Options	Special screening tests, burn-in, etc. can be supplied on special order to meet specific requirements. For information on higher current ratings, contact Littelfuse. 267 series fuses are offered with optional solder coated leads. To order, enter XT as the end suffix (see Part Numbering System section)

Operating Temperature	-55°C to +125°C
Shock	MIL-STD-202, Method 213, Test Condition I (100 G's peak for 6 milliseconds).
Vibration	MIL-STD-202, Method 201 (10-55 Hz); MIL-STD-202, Method 204, Test Condition C (55-2000 Hz at 10 G's Peak)
Salt Spray	MIL-STD-202, Method 101, Test Condition B
Seal Test	MIL-STD-202, Method 112, Test Condition A
Insulation Resistance (After Opening)	MIL-STD-202, Method 302, Test Condition A (1/2 Megohm minimum)
Thermal Shock	MIL-STD-202, Method 107, Test Condition B (-65°C to 125°C).
Moisture Resistance	MIL-STD-202, Method 106
Fuses To MIL SPEC	265 Series (except 1/16 ampere rating) is available in FM08A on QPL for MIL-PRF-23419/8. To order, change 265 to 267

Dimensions

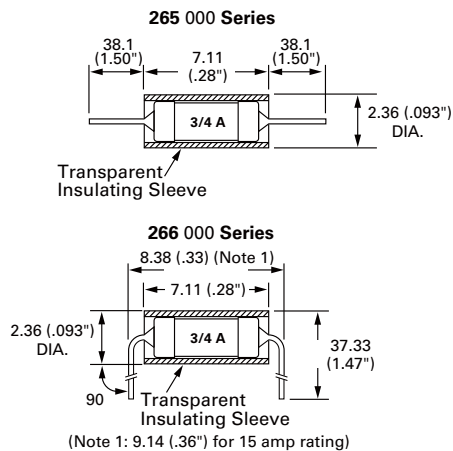

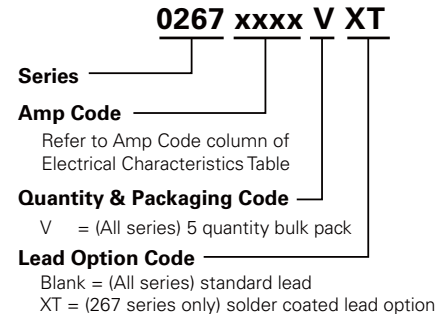

Part Numbering System

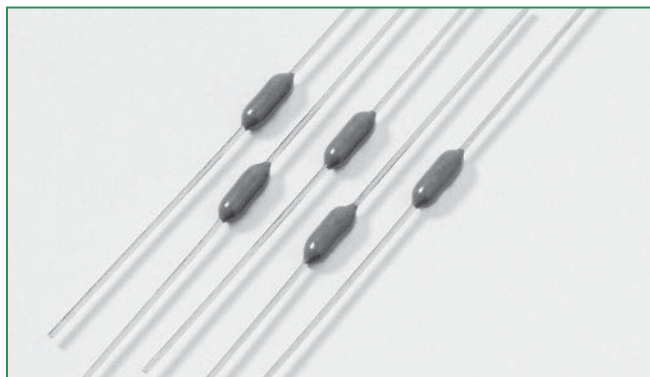

Packaging

Packaging Option	Quantity	Quantity & Packaging Code
Bulk Pack	5	V

RoHS **316 Series PICO® II, Very Fast-Acting Fuse**

Agency Approvals

Agency	Agency File Number	Ampere Range
	2007010207241295	0.50mA–5A

Electrical Characteristics

% of Ampere Rating	Opening Time
100%	4 Hours, Min.
200%	5 Seconds, Max.
275%	0.30 Seconds, Max.
400%	0.03 Seconds, Max.
1000%	0.004 Seconds, Max.

Electrical Characteristics

Ampere Rating (A)	Amp Code	Max Voltage Rating (V)	Interrupting Rating	Nominal Cold Resistance (Ohms)	Nominal Melting I ² t (A ² sec)	Max Voltage Drop (mV)	Agency Approvals 
0.50	.500	125	50A @ 125VAC 50A @ 125VDC	0.280	0.0598	0.202	X
1.00	001.	125		0.128	0.256	0.186	X
2.00	002.	125		0.0473	0.405	0.158	X
3.15	3.15	125		0.0290	1.190	0.160	X
5.00	005.	125		0.0155	4.140	0.110	X

Notes:

1. Cold resistance measured at less than 10% of rated current at 23°C.
2. Agency Approval Table Key: X=Approved or Certified, P=Pending and Blank=Not Approved
3. Have special electrical characteristic needs? Contact Littelfuse to learn more about application specific options.

Description

The 316 Series PICO® II Very Fast-Acting Fuse is designed to meet an extensive array of performance characteristics in a space-saving subminiature package while complying with the requirements of CCC.

Features

- CCC certified Axial Lead Fuse
- Fully compatible with Lead-free solder alloys and higher temperature profiles associated with Lead-free assembly
- RoHS compliant
- Available in ratings of 0.50A, 1.00A, 2.00A, 3.15A and 5.00 amperes

Applications

Secondary protection for space constrained applications

- Flat-panel Display TV
- LCD monitor
- LCD backlight inverter
- Office machines
- Power supply
- Audio/Video system
- Lighting system
- Medical equipment

Temperature Derating Curve

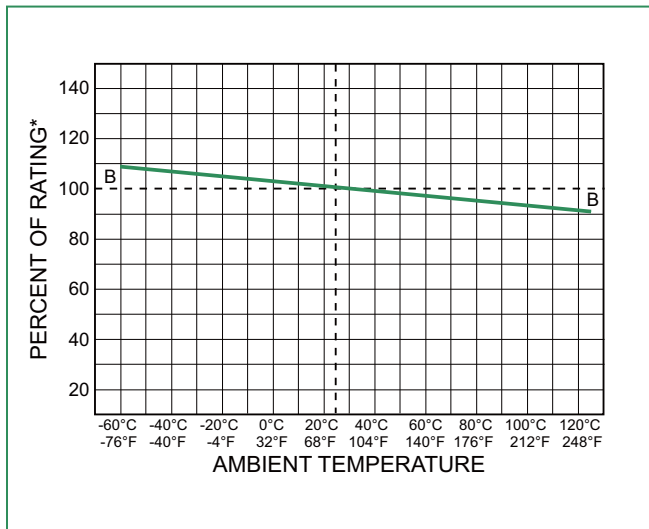

Note:
1. Derating depicted in this curve is in addition to the standard derating of 25% for continuous operation.

Average Time Current Curves

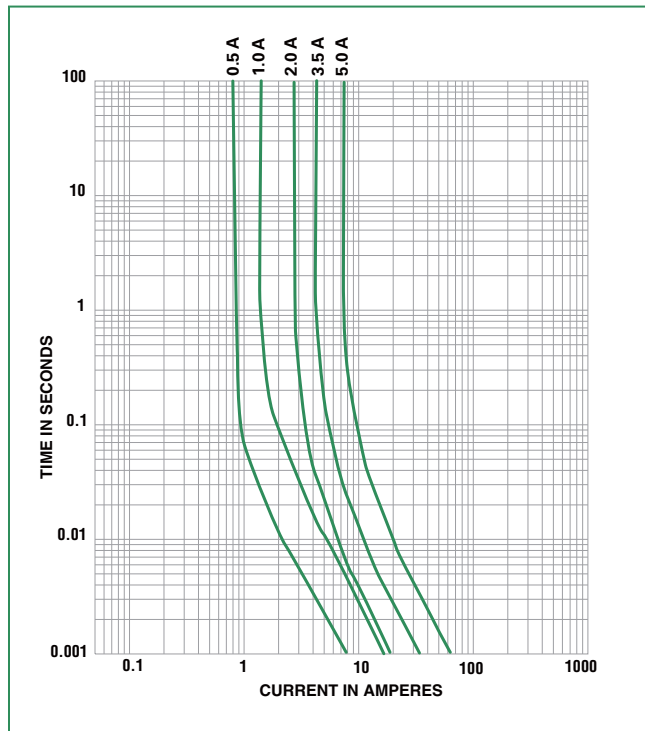

Soldering Parameters

Recommended Process Parameters:

Wave Parameter	Lead-Free Recommendation
Preheat: (Depends on Flux Activation Temperature)	(Typical Industry Recommendation)
Temperature Minimum:	100° C
Temperature Maximum:	150° C
Preheat Time:	60-180 seconds
Solder Pot Temperature:	260° C Maximum
Solder Dwell Time:	10 Seconds, Maximum

Recommended Hand-Solder Parameters:

Solder Iron Temperature: 350° C +/- 5° C
Heating Time: 5 seconds max.

Note: These devices are not recommended for IR or Convection Reflow process.

Product Characteristics

Materials	Body: Ceramic Leads: Tin-coated Copper Encapsulated: Epoxy-Coated body
Product Marking	Body: Brand Logo, Current Rating Certification mark
Lead Pull Force	MIL-STD-202, Method 211, Test Condition A (will withstand a 7lbs. axial pull test)
Solderability	MIL-STD-202, Method 208

Operating Temperature	-55°C to +125°C with proper de-rating
Shock	MIL-STD-202, Method 213, Test Condition 1 (100G's peak for millisecond)
Vibration	MIL-STD-202F, Method 201A (10-55 Hz); Method 204, Test Condition C
Moisture Resistance	MIL-STD-202, Method 106

Dimensions

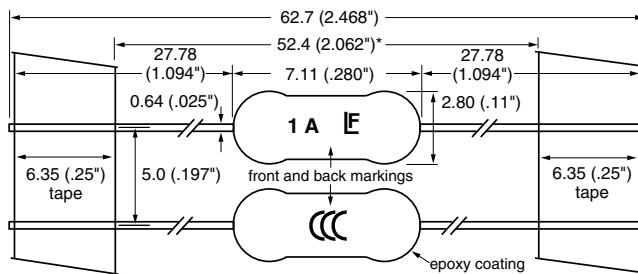

Part Numbering System

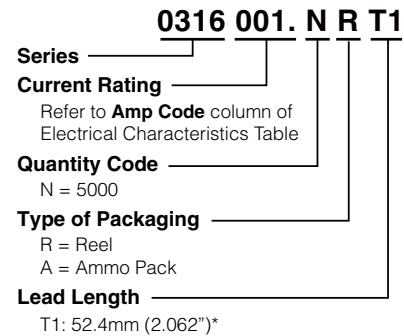

Packaging

Packaging Option	Packaging Specification	Quantity	Quantity & Packaging Code
*T1: 52.4mm (2.062") Axial Lead Tape and Reel or Ammo Pack	EIA 296	5000	NAT1 = 5000 Ammo Pack T1 NRT1 = 5000 Tape & Reel T1

Notes: * T1 dimension is defined as the length of the component between the two tapes. The full component length is 62.7mm (2.468").

RoHS **Pb** **874 Series Fuse, Lead-free 3.6 x 10 mm, Fast-Acting Fuse**

Agency	Agency File Number	Ampere Range
	E10480	0.100A - 10 A

Description

Single Pigtail Axial Lead 3.6 x 10mm Fast-Acting Fuse

Features

- Designed to UL/CSA 248 Standard
- Single Pigtail Axial Lead format
- Fast Acting, Ceramic body fuse in a compact package
- Pb-free, RoHS Compliant
- Available in ratings of 0.10 to 10 Amperes

Applications

This space saving fuse is ideally suited for lighting, power supply, and adapter applications.

Electrical Characteristics

% of Ampere Rating	Opening Time
100%	4 hours, Minimum
200%	5 seconds, Maximum

Electrical Characteristics

Amp Code	Ampere Rating (A)	Voltage Rating (V)	Interrupting Rating	Nominal Cold Resistance (Ohms)	Nominal Melting I ² t (A ² sec)	Agency Approvals
.100	0.100	250	50A @ 250 VAC	3.000	0.0054	x
.125	0.125	250		2.0600	0.0072	x
.200	0.200	250		0.9200	0.0165	x
.250	0.250	250		0.6920	0.030	x
.300	0.300	250		0.5800	0.039	x
.400	0.400	250		0.3655	0.120	x
.500	0.500	250		0.2964	0.236	x
.600	0.600	250		0.2667	0.245	x
.750	0.750	250		0.2130	0.256	x
.800	0.800	250		0.1600	0.390	x
001.	1.00	250		0.0860	0.406	x
01.5	1.50	250		0.0563	0.974	x
01.6	1.60	250		0.0525	0.973	x
002.	2.00	250		0.0400	1.812	x
02.5	2.50	250		0.0329	2.675	x
3.15	3.15	250		0.0216	5.904	x
004.	4.00	250		0.0195	10.03	x
04.5	4.50	250		0.0146	14.42	x
005.	5.00	250		0.0139	14.58	x
006.	6.00	250		0.0111	23.08	x
06.3	6.30	250	0.01074	22.90	x	
06.5	6.50	250	0.0100	35.24	x	
007.	7.00	250	0.0099	36.90	x	
008.	8.00	250	0.0087	43.97	x	
010.	10.00	250	0.0066	70.10	x	

Notes:
Cold resistance measured at less than 10% of rated current at 23°C.

Temperature Derating Curve

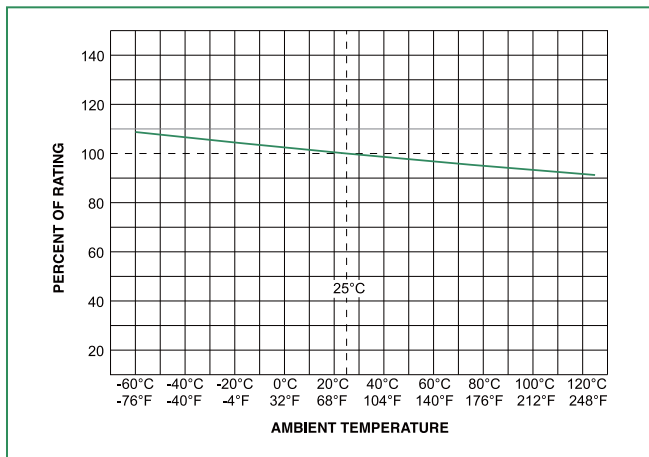

Average Time Current Curves

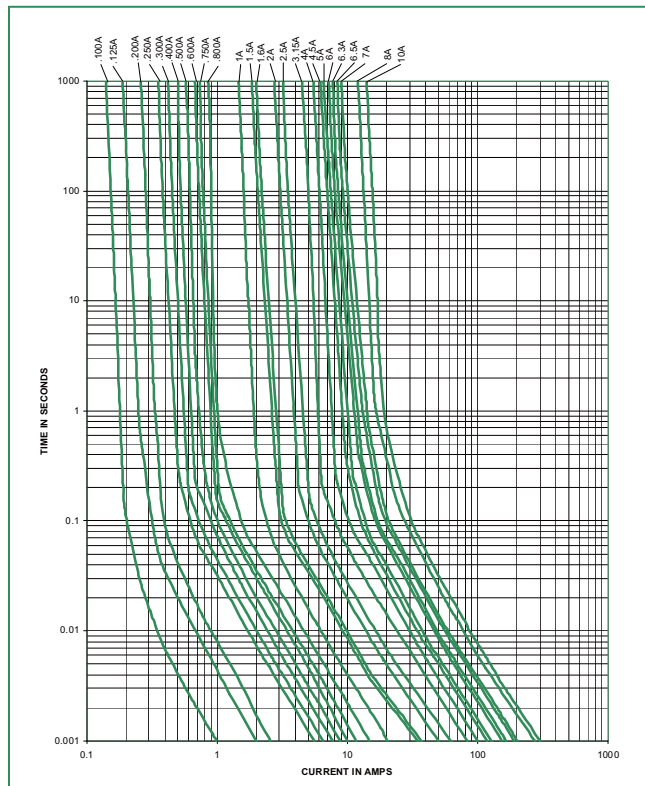

Soldering Parameters - Wave Soldering

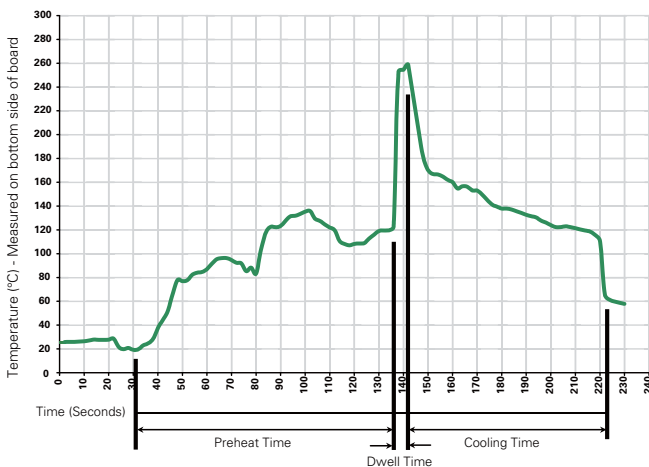

Recommended Process Parameters:

Wave Parameter	Lead-Free Recommendation
Preheat: (Depends on Flux Activation Temperature) (Typical Industry Recommendation)	
Temperature Minimum:	100° C
Temperature Maximum:	150° C
Preheat Time:	60-180 seconds
Solder Pot Temperature:	260° C Maximum
Solder Dwell Time:	2-5 seconds

Recommended Hand-Solder Parameters:

Solder Iron Temperature: 350° C +/- 5° C
 Heating Time: 5 seconds max.

Note: These devices are not recommended for IR or Convection Reflow process.

Product Characteristics

Materials	Body: Ceramic Cap: Nickel Plated Brass Tin Plated Copper
Terminal Strength	MIL-STD-202F Method 211A, Test Condition A
Solderability	Reference IEC 60127 Second Edition 2003-01 Annex A
Product Marketing	Body: Brand Logo, Current Rating Characteristic "F"; Agency approval marks
Packaging	Bulk (1000 pcs/pkg) Tape & Reel (1000 pcs/reel)

Operating Temperature	-55°C to 125°C
Thermal Shock	MIL-STD-202F, Method 107G Test Condition B3 (5 cycles -65°C to +125°C)
Vibration	MIL-STD-202F, Method 201A (10-55 Hz)
Humidity	MIL-STD-202, Method 106, High Humidity (90-98%RH), Heat (65°C)
Salt Spray	MIL-STD-202F, Method 101D, Test Condition B

Dimensions

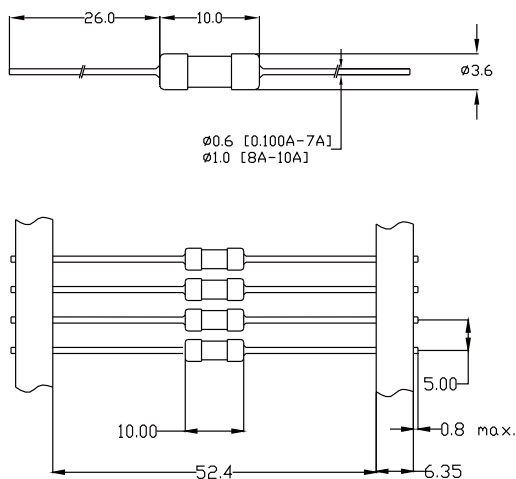

All dimensions in mm

Part Numbering System

0874 xxxx M X E P

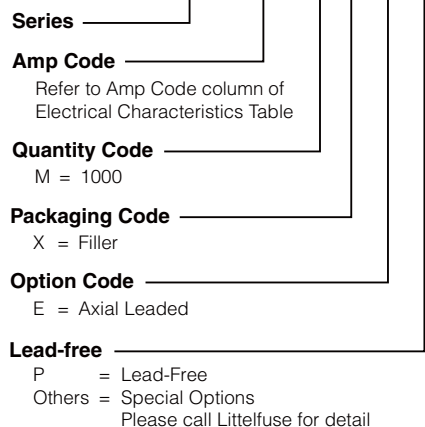

Packaging

Packaging Option	Packaging Specification	Quantity	Quantity & Packaging Code	Taping Width
874 Series				
Bulk	Bulk	1000	MXE	N/A
Tape and Reel	EIA 296	1000	MRET1	T1 = 52mm (2.062")

RoHS  **875 Series Fuse, Lead-free 3.6 x 10 mm, Slo-Blo® Fuse**



Agency	Agency File Number	Ampere Range
	E10480	0.100A - 10 A

Description

Single Pigtail Axial Lead 3.6x10mm, Slo-Blo Fuse

Features

- Designed to UL/CSA 248 Standard
- Single Pigtail Axial Lead format
- Slo-Blo, ceramic body fuse in a compact package
- Pb-free, RoHS Compliant
- Available in ratings of 0.10 to 10 Amperes

Applications

This space saving fuse is ideally suited for lighting, power supply, and adapter applications.

Electrical Characteristics

% of Ampere Rating	Opening Time
100%	4 hours, Minimum
200%	60 seconds, Maximum

Electrical Characteristics

Amp Code	Ampere Rating (A)	Voltage Rating (V)	Interrupting Rating	Nominal Cold Resistance (Ohms)	Nominal Melting I ² t (A ² sec)	Agency Approvals
						
.100	0.100	250	50A @ 250 VAC	2.900	0.0054	x
.125	0.125	250		1.850	0.0072	x
.200	0.200	250		0.920	0.0165	x
.250	0.250	250		0.6575	0.038	x
.300	0.300	250		0.435	0.043	x
.400	0.400	250		0.321	0.136	x
.500	0.500	250		0.256	0.288	x
.600	0.600	250		0.151	0.611	x
.800	0.800	250		0.116	0.919	x
001.	1.00	250		0.095	1.503	x
01.5	1.50	250		0.0519	4.33	x
01.6	1.60	250		0.0476	5.08	x
002.	2.00	250		0.02887	8.45	x
02.5	2.50	250		0.02246	17.85	x
003.	3.00	250		0.0171	24.50	x
004.	4.00	250		0.0135	42.45	x
005.	5.00	250		0.00954	60.90	x
006.	6.00	250		0.00891	72.30	x
007.	7.00	250		0.008	106.80	x
008.	8.00	250		0.0077	134.59	x
010.	10.00	250	0.00675	208.00	x	

Notes:
Cold resistance measured at less than 10% of rated current at 23°C.

Temperature Derating Curve

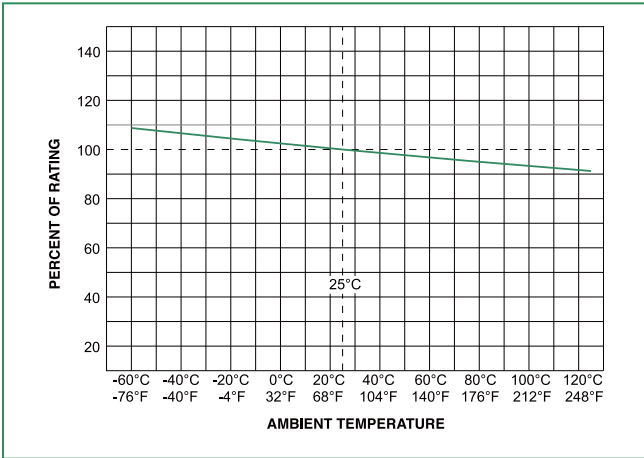

Average Time Current Curves

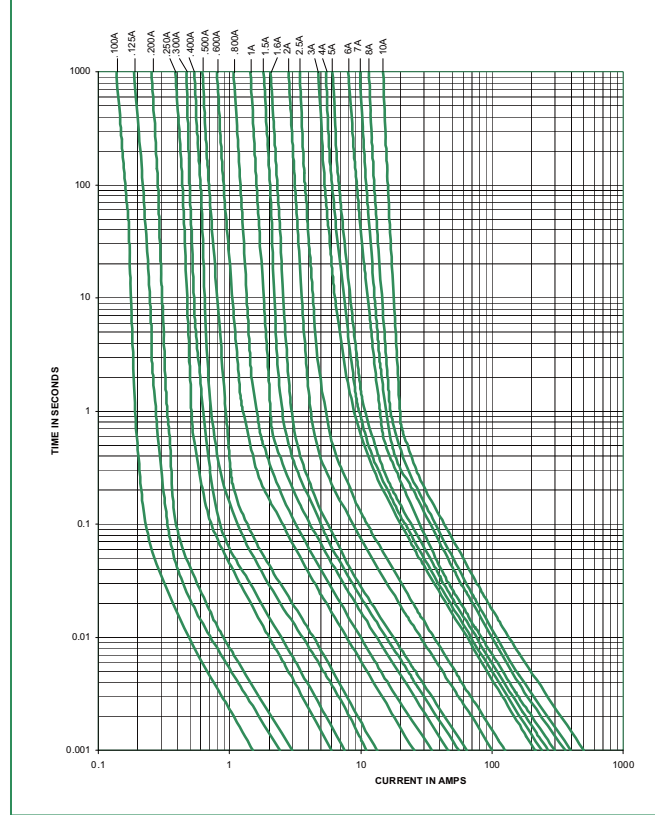

Soldering Parameters - Wave Soldering

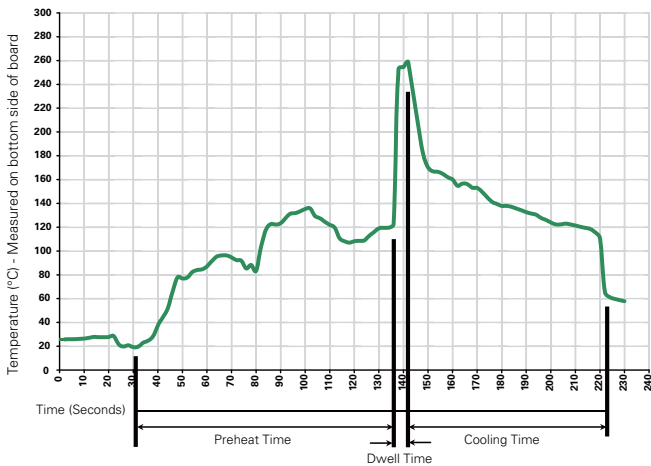

Recommended Process Parameters:

Wave Parameter	Lead-Free Recommendation
Preheat: (Depends on Flux Activation Temperature)	
Temperature Minimum:	100° C
Temperature Maximum:	150° C
Preheat Time:	60-180 seconds
Solder Pot Temperature:	260° C Maximum
Solder Dwell Time:	2-5 seconds

Recommended Hand-Solder Parameters:

Solder Iron Temperature: 350° C +/- 5° C
 Heating Time: 5 seconds max.

Note: These devices are not recommended for IR or Convection Reflow process.

Product Characteristics

Materials	Body: Ceramic Cap: Nickel Plated Brass Tin Plated Copper
Terminal Strength	MIL-STD-202F Method 211A, Test Condition A
Solderability	Reference IEC 60127 Second Edition 2003-01 Annex A
Product Marketing	Body: Brand Logo, Current Rating Characteristic "T"; Agency approval marks
Packaging	Bulk (1000 pcs/pkg) Tape & Reel (1000 pcs/reel)

Operating Temperature	-55°C to 125°C
Thermal Shock	MIL-STD-202F, Method 107G Test Condition B3 (5 cycles -65°C to +125°C)
Vibration	MIL-STD-202F, Method 201A (10-55 Hz)
Humidity	MIL-STD-202, Method 106, High Humidity (90-98%RH), Heat (65°C)
Salt Spray	MIL-STD-202F, Method 101D, Test Condition B

Dimensions

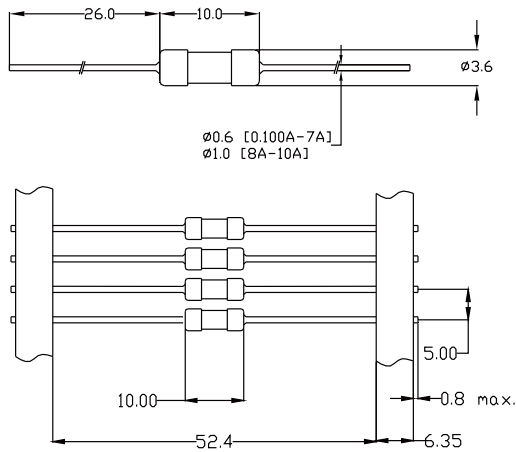

All dimensions in mm

Part Numbering System

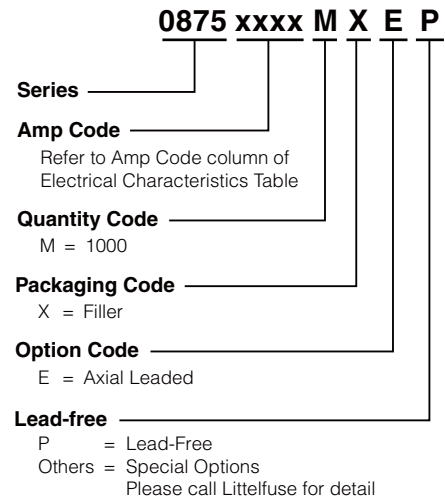



Packaging

Packaging Option	Packaging Specification	Quantity	Quantity & Packaging Code	Taping Width
875 Series				
Bulk	Bulk	1000	MXE	N/A
Tape and Reel	EIA 296	1000	MRET1	T1 = 52mm (2.062")

RoHS  **876 Series Fuse, Lead-free 3.6 x 10 mm, Fast-Acting Fuse**



Agency	Agency File Number	Ampere Range
	40022494	0.125 – 0.630A 1.6 – 5A
	E10480	0.125 – 5A

Description

Single Pigtail Axial Lead 3.6 x 10mm Fast-Acting Fuse

Features

- Designed to meet IEC 60127-3 Standard Sheet 3
- Fast-Acting, ceramic body fuse in a compact package
- Single Pigtail Axial Lead format
- Pb-free, RoHS compliant
- Available in ratings of .125 to 5 Amperes



Applications

- This space saving fuse is ideally suited for lighting, power supply, and adapter applications.

Electrical Characteristics

% of Ampere Rating	Opening Time
150%	60 minutes, Minimum
210%	30 minutes, Maximum
275%	10 ms., Min.; 3 sec. Max.
400%	3 ms., Min.; 300 ms. Max.
1000%	20 ms. Max.

Electrical Characteristics

Amp Code	Ampere Rating (A)	Voltage Rating (V)	Interrupting Rating	Nominal Cold Resistance (Ohms)	Nominal Melting I ² t (A ² sec)	Nominal Voltage Drop (mV)	Nominal Power Dissipation (mW)	Agency Approvals	
									
.125	0.125	250	35A @ 250 V AC	1.066	0.020	168	60	x	x
.160	0.160	250	35A @ 250 V AC	1.000	0.028	183	92	x	x
.250	0.250	250	35A @ 250 V AC	0.573	0.110	87	62	x	x
.630	0.630	250	35A @ 250 V AC	0.131	0.170	102	221	x	x
01.6	1.6	250	35A @ 250 V AC	0.0388	1.8	70	382	x	x
002.	2.0	250	35A @ 250 V AC	0.0329	2.51	70	470	x	x
004.	4.0	250	40A @ 250 V AC	0.0149	14.64	70	985	x	x
005.	5.0	250	50A @ 250 V AC	0.0111	26.85	66	1200	x	x

Notes:
Cold resistance measured at less than 10% of rated current at 23°C.

Temperature Derating Curve

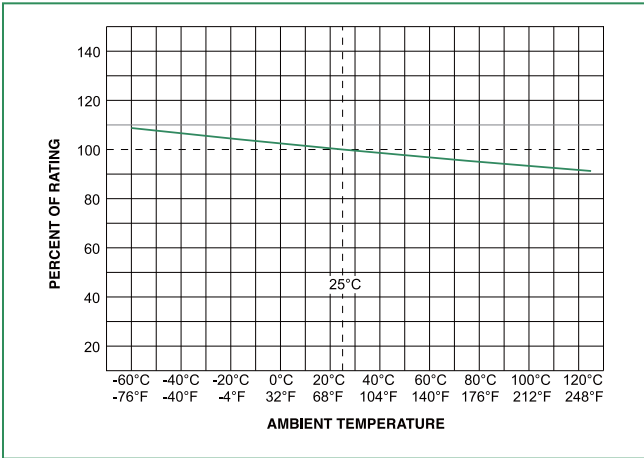

Average Time Current Curves

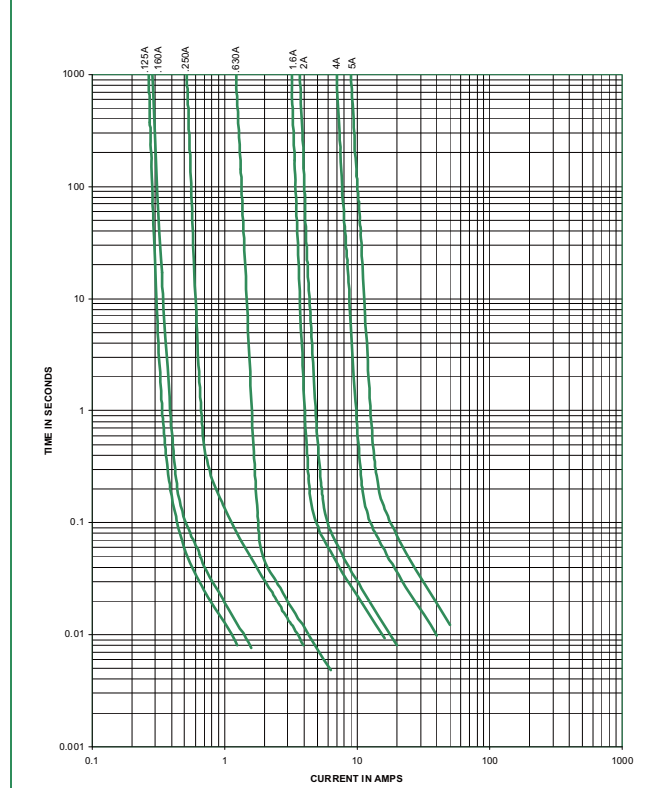

Soldering Parameters - Wave Soldering

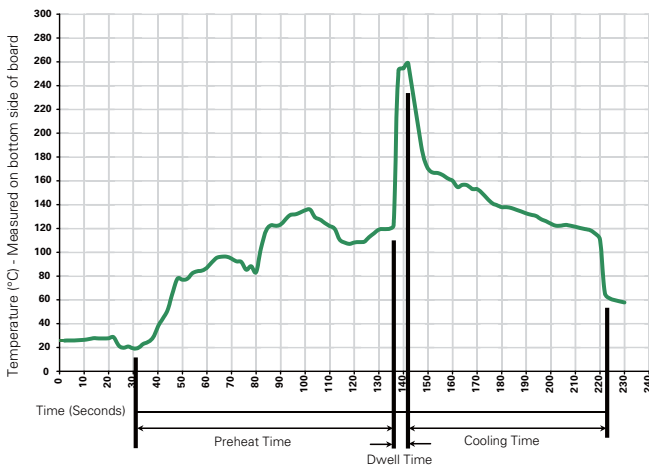

Recommended Process Parameters:

Wave Parameter	Lead-Free Recommendation
Preheat: (Depends on Flux Activation Temperature) (Typical Industry Recommendation)	
Temperature Minimum:	100° C
Temperature Maximum:	150° C
Preheat Time:	60-180 seconds
Solder Pot Temperature:	260° C Maximum
Solder Dwell Time:	2-5 seconds

Recommended Hand-Solder Parameters:

Solder Iron Temperature: 350° C +/- 5° C
 Heating Time: 5 seconds max.

Note: These devices are not recommended for IR or Convection Reflow process.

Product Characteristics

Materials	Body: Ceramic Cap: Nickel Plated Brass Tin Plated Copper
Terminal Strength	MIL-STD-202F Method 211A, Test Condition A
Solderability	Reference IEC 60127 Second Edition 2003-01 Annex A
Product Marketing	Body: Brand Logo, Current Rating Characteristic "F"; Agency approval marks
Packaging	Bulk (1000 pcs/pkg) Tape & Reel (1000 pcs/reel)

Operating Temperature	-55°C to 125°C
Thermal Shock	MIL-STD-202F, Method 107G Test Condition B3 (5 cycles -65°C to +125°C)
Vibration	MIL-STD-202F, Method 201A (10-55 Hz)
Humidity	MIL-STD-202, Method 106, High Humidity (90-98%RH), Heat (65°C)
Salt Spray	MIL-STD-202F, Method 101D, Test Condition B

Dimensions

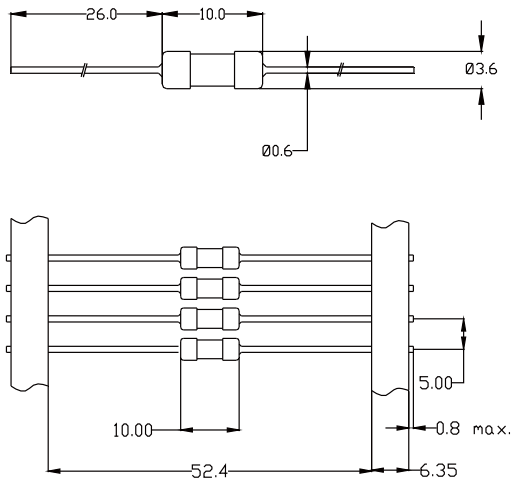

All dimensions in mm

Part Numbering System

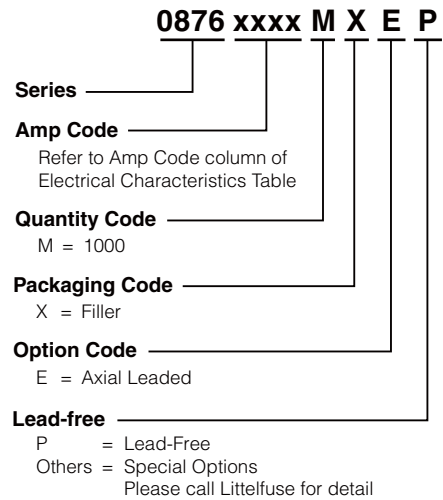

Packaging

Packaging Option	Packaging Specification	Quantity	Quantity & Packaging Code	Taping Width
876 Series				
Bulk	Bulk	1000	MXE	N/A
Tape and Reel	EIA 296	1000	MRET1	T1 = 52mm (2.062")

RoHS  **877 Series Fuse, Lead-free 3.6 x 10 mm, Slo-Blo® Fuse**



Description



Single Pigtail Axial Lead 3.6x10mm, Slo-Blo Fuse

Features

- Designed to meet IEC 60127-3 Standard Sheet 4
- Slo-Blo, ceramic body fuse in a compact package
- Single Pigtail Axial Lead format
- Pb-free, RoHS compliant
- Available in ratings of 2 to 6.3 Amperes

Applications



This space saving fuse is ideally suited for lighting, power supply, and adapter applications.

Agency	Agency File Number	Ampere Range
	40023242	2A – 6.3A
	E10480	2A – 6.3A

Electrical Characteristics

% of Ampere Rating	Opening Time
150%	60 minutes, Minimum
210%	2 minutes, Maximum
275%	400 ms., Min.; 10 sec. Max.
400%	150 ms., Min.; 3 sec. Max.
1000%	20 ms. Min.; 150 ms. Max.

Electrical Characteristics

Amp Code	Ampere Rating (A)	Voltage Rating (V)	Interrupting Rating	Nominal Cold Resistance (Ohms)	Nominal Melting I ² t (A ² sec)	Nominal Voltage Drop (mV)	Nominal Power Dissipation (mW)	Agency Approvals	
									
002.	2.0	250	35A @ 250 V AC	0.035	24.6	82	450	x	x
3.15	3.15	250	35A @ 250 V AC	0.020	67.6	76	690	x	x
004.	4.0	250	40A @ 250 V AC	0.0167	143.4	74	926	x	x
06.3	6.3	250	63A @ 250 V AC	0.0087	190	60	1130	x	x

Notes:
 1. Cold resistance measured at less than 10% of rated current at 23°C.

877 Series

Temperature Derating Curve

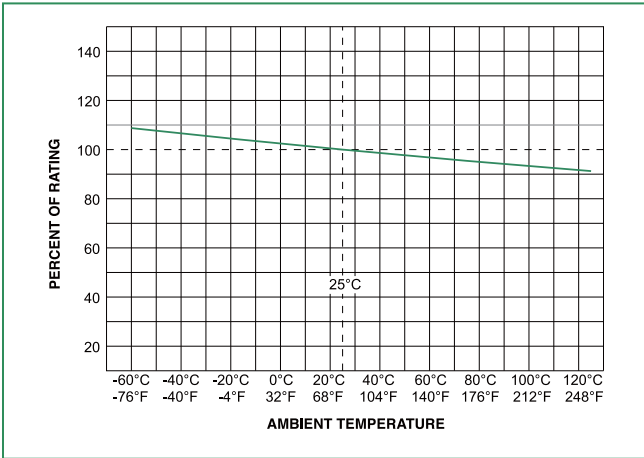

Average Time Current Curves

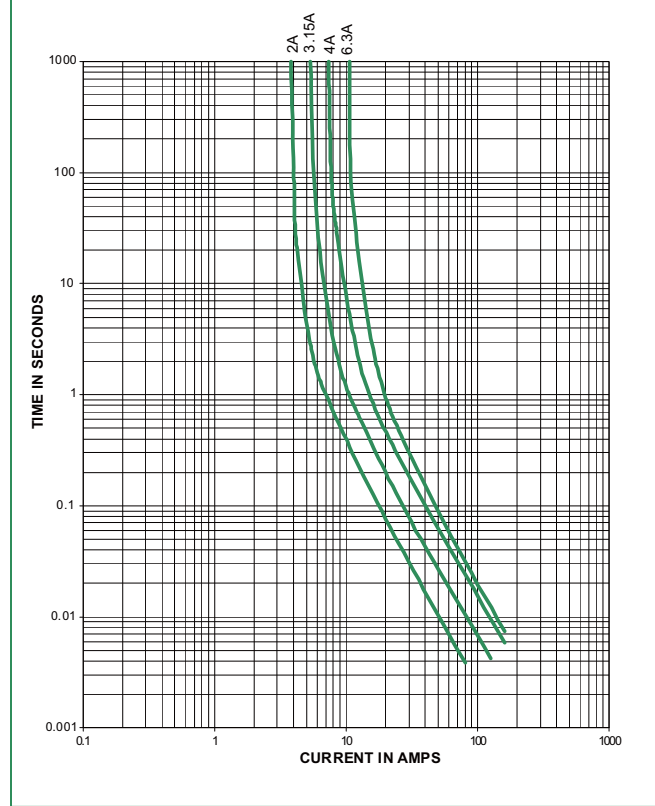

Soldering Parameters - Wave Soldering

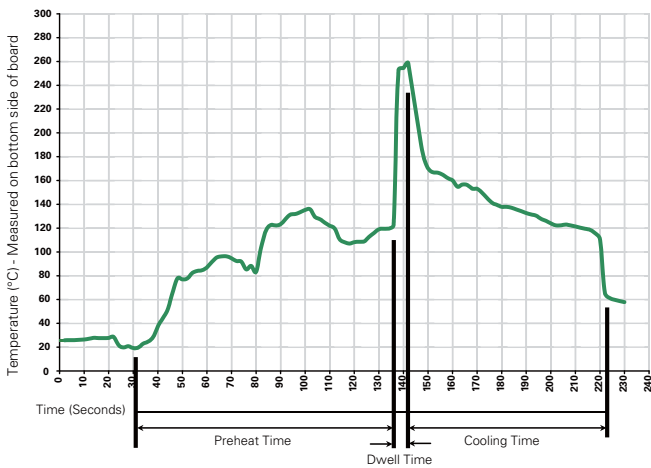

Recommended Process Parameters:

Wave Parameter	Lead-Free Recommendation
Preheat: (Depends on Flux Activation Temperature)	(Typical Industry Recommendation)
Temperature Minimum:	100° C
Temperature Maximum:	150° C
Preheat Time:	60-180 seconds
Solder Pot Temperature:	260° C Maximum
Solder Dwell Time:	2-5 seconds

Recommended Hand-Solder Parameters:

Solder Iron Temperature: 350° C +/- 5° C
 Heating Time: 5 seconds max.

Note: These devices are not recommended for IR or Convection Reflow process.

Product Characteristics

Materials	Body: Ceramic Cap: Nickel Plated Brass Tin Plated Copper
Terminal Strength	MIL-STD-202F Method 211A, Test Condition A
Solderability	Reference IEC 60127 Second Edition 2003-01 Annex A
Product Marketing	Body: Brand Logo, Current Rating Characteristic "T"; Agency approval marks
Packaging	Bulk (1000 pcs/pkg) Tape & Reel (1000 pcs/reel)

Operating Temperature	-55°C to 125°C
Thermal Shock	MIL-STD-202F, Method 107G Test Condition B3 (5 cycles -65°C to +125°C)
Vibration	MIL-STD-202F, Method 201A (10-55 Hz)
Humidity	MIL-STD-202, Method 106, High Humidity (90-98%RH), Heat (65°C)
Salt Spray	MIL-STD-202F, Method 101D, Test Condition B

Dimensions

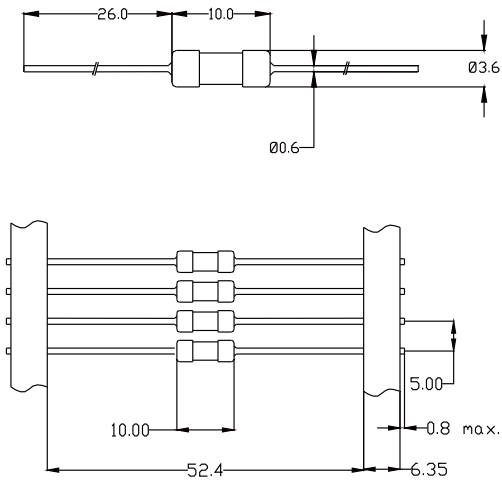

All dimensions in mm

Part Numbering System

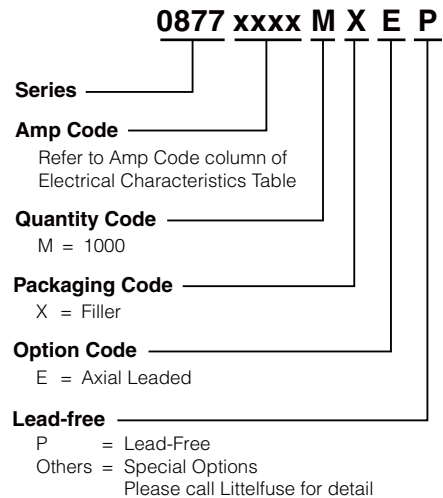

Packaging

Packaging Option	Packaging Specification	Quantity	Quantity & Packaging Code	Taping Width
877 Series				
Bulk	Bulk	1000	MXE	N/A
Tape and Reel	EIA 296	1000	MRET1	T1 = 52mm (2.062")

RoHS  **208 Series** Lead-Free 2AG, Fast-Acting Fuse

Description

Littelfuse 208 Series (2AG) 350V Fast-Acting Fuses are available in cartridge form or with axial leads. This series provides the same performance characteristics as its 3AG counterpart, while occupying one-third the space. Sleeved fuses are available.



Features

- In accordance with Underwriter's Laboratories Standard UL 248-14
- Fuses are boardwashable in most solvents
- Available in cartridge and axial lead form and with various lead forming dimensions
- RoHS compliant and Lead-free

Applications

- Electrical ballasts used in fluorescent lighting and other applications



Agency Approvals

Agency	Agency File Number	Ampere Range
	E10480	125mA - 10A
	NBK200405-E10480 C/D NBK060405-E10480 E/F	1A - 5A 6A - 10A
		125mA - 10A

Electrical Characteristics for Series

% of Ampere Rating	Opening Time
100%	4 Hours, Min.
135%	1 Hour, Max.
200%	1 Second, Max.

Electrical Characteristic Specifications by Item

Amp Code	Amp Rating	Voltage Rating	Interrupting Rating	Nominal Cold Resistance (Ohms)	Nominal Melting I ² t (A ² sec)	Agency Approvals		
								
.125	0.125	350	100A @ 350V AC	3.900	0.00286	x		x
.250	0.250	350		1.150	0.0300	x		x
.375	0.375	350		0.395	0.171	x		x
.500	0.500	350		0.265	0.365	x		x
.750	0.750	350		0.152	1.050	x		x
001.	1.0	350		0.103	2.220	x	x	x
01.5	1.5	350		0.0712	0.800	x	x	x
002.	2.0	350		0.0497	1.50	x	x	x
02.5	2.5	350		0.0372	2.68	x	x	x
003.	3.0	350		0.0317	4.62	x	x	x
03.5	3.5	350		0.0265	6.70	x	x	x
004.	4	350		0.0240	9.40	x	x	x
005.	5	350		0.0186	17.00	x	x	x
006.	6	350		0.0154	22.10	x	x	x
007.	7	350		0.0130	40	x	x	x
008.	8	350		0.0107	56	x	x	x
010.	10	350	0.0075	116	x	x	x	

Temperature Derating Curve

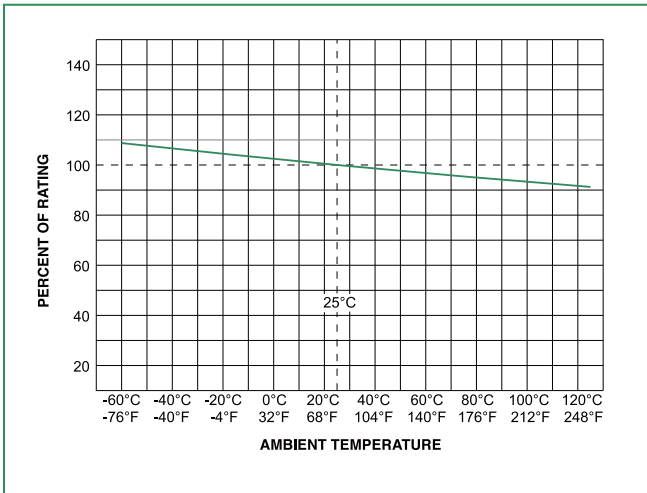

Average Time Current Curves

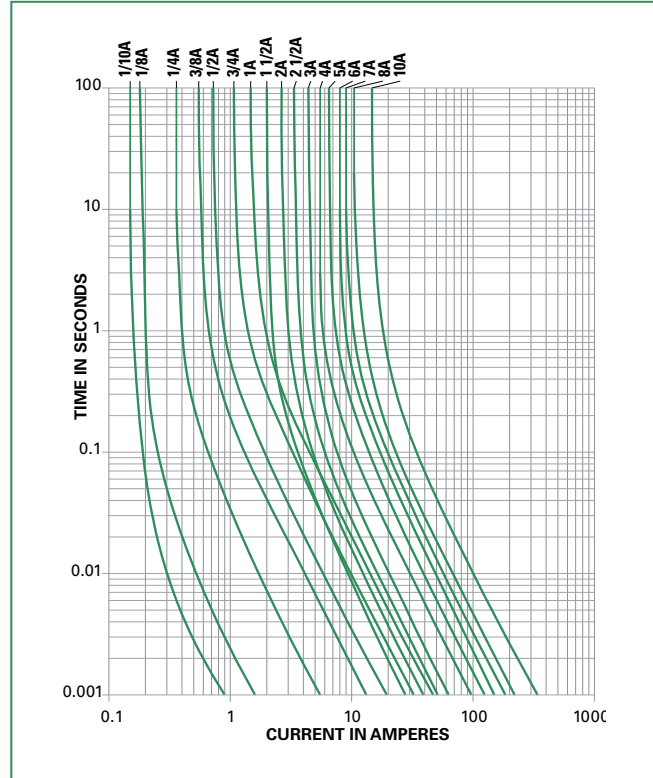

Soldering Parameters - Wave Soldering

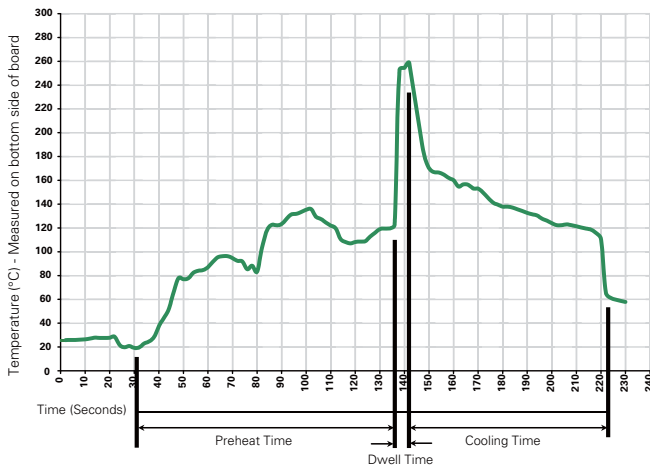

Recommended Process Parameters:

Wave Parameter	Lead-Free Recommendation
Preheat: (Depends on Flux Activation Temperature)	(Typical Industry Recommendation)
Temperature Minimum:	100° C
Temperature Maximum:	150° C
Preheat Time:	60-180 seconds
Solder Pot Temperature:	260° C Maximum
Solder Dwell Time:	2-5 seconds

Recommended Hand-Solder Parameters:

Solder Iron Temperature: 350° C +/- 5°C
 Heating Time: 5 seconds max.

Note: These devices are not recommended for IR or Convection Reflow process.

Product Characteristics

Materials	Body : Glass Cap : Nickel-plated brass Leads: Tin-plated Copper
Terminal Strength	MIL-STD-202G, Method 211A, Test Condition A
Solderability	Reference IEC 60127 Second Edition 2003-01 Annex A
Product Marking	Cap1 : Brand logo, current and voltage ratings Cap2 : Series and agency approval marks

Operating Temperature:	-55°C to 125°C.
Thermal Shock:	MIL-STD-202G, Method 107G, Test Condition B (5 Cycles -65°C to +125°C).
Vibration	MIL-STD-202G, Method 201A
Humidity	MIL-STD-202G, Method 103B, Test Condition A: High RH (95%) and elevated temp (40°C) for 240 hours
Salt Spray	MIL-STD-202G, Method 101D, Test Condition B

Dimensions

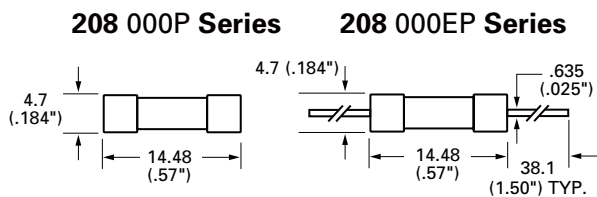

Part Numbering System

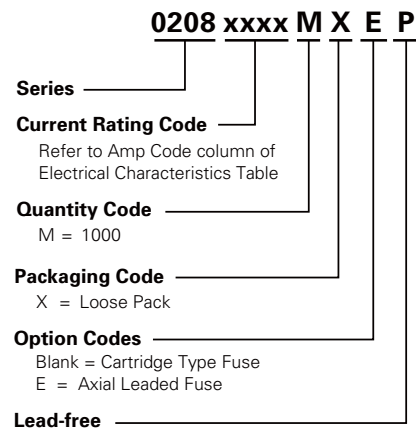

Packaging

Packaging Option	Packaging Specification	Quantity	Quantity & Packaging Code	Taping Width
208 Series				
Bulk	N/A	1000	MX	N/A
Bulk	N/A	1000	MXE	N/A
Reel and Tape	EIA 296-E	1500	DRT1	T1=52mm (2.062")

RoHS  **209 Series** Lead-Free 2AG, Slo-Blo® (Time-Lag) Fuse



Description

Littelfuse 209 Series (2AG) 350V, Time-Lag (Slo-Blo®) Fuses are available in cartridge form or with axial leads. This series provides the same performance characteristics as its 3AG counterpart, while occupying one-third the space. Sleeved fuses are available.



Features

- In accordance with Underwriter's Laboratories Standard UL 248-14
- Fuses are boardwashable in most solvents
- Available in cartridge and axial lead form and with various forming dimensions
- RoHS compliant and Lead-free

Applications

- Electronic Lighting Ballasts



Agency Approvals

Agency	Agency File Number	Ampere Range
	E10480	250mA - 1A
	NBK210405-E10480 G/H	1A
		250mA - 1A

Electrical Characteristics for Series

% of Ampere Rating	Opening Time
100%	4 Hours, Min.
135%	1 Hour, Max.
200%	3 Sec. Min. ; 20 Sec. Max.

Electrical Characteristic Specifications by Item

Amp Code	Ampere Rating (A)	Voltage Rating (V)	Interrupting Rating	Nominal Cold Resistance (Ohms)	Nominal Melting I ² t (A ² sec)	Agency Approvals		
								
.250	0.25	350	100A @ 350Vac	2.410	0.216	x		x
.375	0.375	350		1.170	0.580	x		x
.500	0.5	350		0.688	1.160	x		x
.600	0.6	350		0.477	1.750	x		x
.750	0.75	350		0.340	2.950	x		x
.800	0.8	350		0.304	3.450	x		x
.001	1	350		0.210	5.640	x	x	x

Temperature Derating Curve

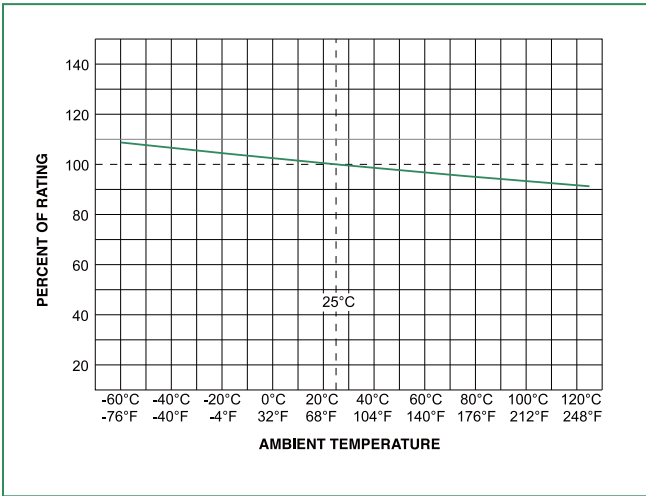

Average Time Current Curves

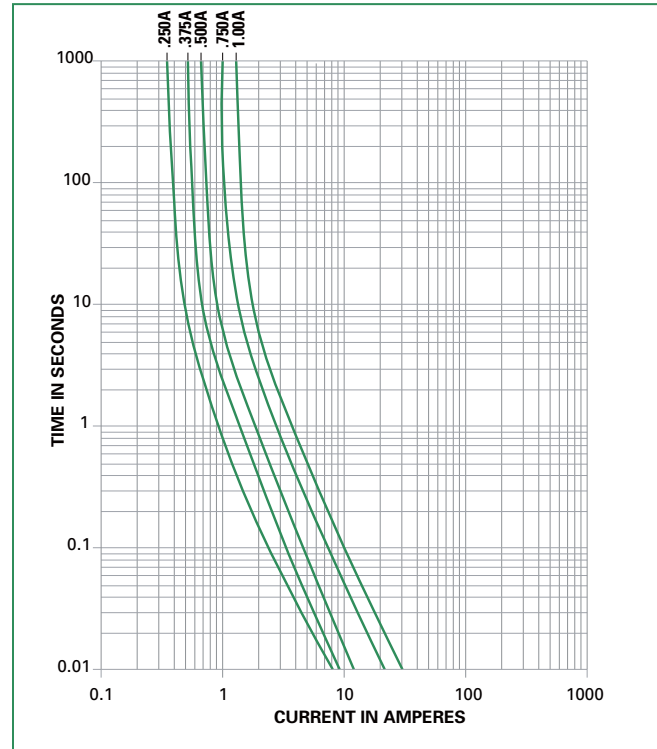

Soldering Parameters - Wave Soldering

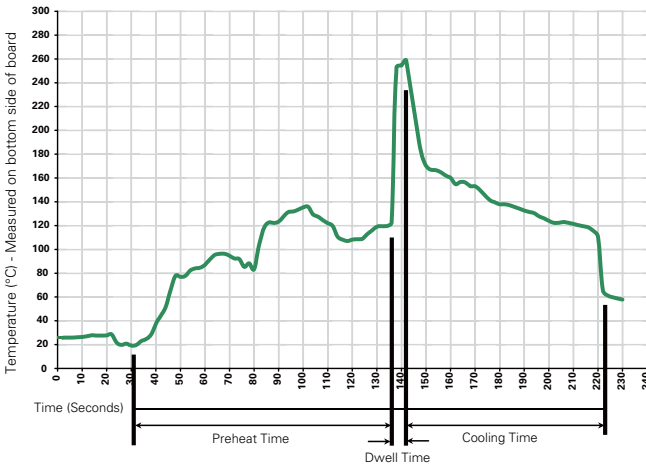

Recommended Process Parameters:

Wave Parameter	Lead-Free Recommendation
Preheat: (Depends on Flux Activation Temperature)	
Temperature Minimum:	100° C (Typical Industry Recommendation)
Temperature Maximum:	150° C
Preheat Time:	60-180 seconds
Solder Pot Temperature:	260° C Maximum
Solder Dwell Time:	2-5 seconds

Recommended Hand-Solder Parameters:

Solder Iron Temperature: 350° C +/- 5° C
 Heating Time: 5 seconds max.

Note: These devices are not recommended for IR or Convection Reflow process.

Product Characteristics

Materials	Body : Glass Cap : Nickel-plated brass Leads: Tin-plated Copper
Terminal Strength	MIL-STD-202G, Method 211A, Test Condition A
Solderability	Reference IEC 60127 Second Edition 2003-01 Annex A
Product Marking	Cap1 : Brand logo, current and voltage ratings Cap2 : Series and agency approval marks

Operating Temperature:	-55°C to 125°C.
Thermal Shock:	MIL-STD-202G, Method 107G, Test Condition B (5 Cycles -65°C to +125°C).
Vibration	MIL-STD-202G, Method 201A
Humidity	MIL-STD-202G, Method 103B, Test Condition A: High RH (95%) and elevated temp (40°C) for 240 hours
Salt Spray	MIL-STD-202G, Method 101D, Test Condition B

Dimensions

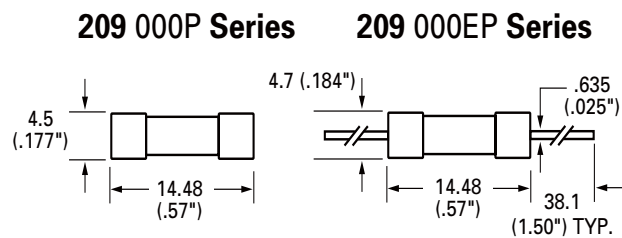

Part Numbering System

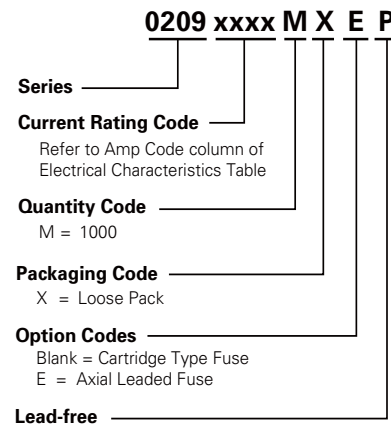

Packaging

Packaging Option	Packaging Specification	Quantity	Quantity & Packaging Code	Taping Width
209 Series				
Bulk	N/A	1000	MX	N/A
Bulk	N/A	1000	MXE	N/A
Reel and Tape	EIA 296-E	1500	DRT1	T1=52mm (2.062")

RoHS  **224/225 Series** Lead-Free 2AG, Fast-Acting

Description

The 2AG Fast-Acting Fuses are available in cartridge form or with axial leads. 2AG Fuses provide the same performance characteristics as their 3AG counterpart, while occupying one-third the space. Sleeved fuses are available.





Features

- In accordance with underwriter's Laboratories Standard UL 248-14
- Available in cartridge and axial lead form and with various forming dimensions
- Fuses are boardwashable in most solvents
- RoHS compliant and Lead-free

Applications

Used as supplementary protection in appliance or utilization equipment to provide individual protection for components or internal circuits.





Agency Approvals

Agency	Agency File Number	Ampere Range
	E10480	100mA - 3.5A
	E10480	4A - 10A
	LR 29862	100mA - 10A
	NBK200405-E10480 NBK060405-E10480	Cartridge: 1A - 10A Pigtail: 1A - 10A
		100mA - 10A

Electrical Characteristics for Series

% of Ampere Rating	Opening Time
100%	4 hours, Minimum
135%	1 hour, Maximum
200%	1 sec., Maximum

Electrical Characteristic Specifications by Item

Amp Code	Ampere Rating (A)	Voltage Rating (V)	Interrupting Rating	Nominal Cold Resistance (Ohms)	Nominal Melting I ² t (A ² sec)	Agency Approvals				
										
.100	.1	250	35A@250Vac 10KA@125Vac 10KA@125Vdc	6.1500	0.00075	x		x		x
.125	0.125	250		3.9000	0.00286	x		x		x
.250	0.25	250		1.1500	0.0300	x		x		x
.375	0.375	250		0.3950	0.171	x		x		x
.500	0.5	250		0.2650	0.365	x		x		x
.750	0.75	250		0.1520	1.050	x		x		x
001.	1	250		0.1027	2.220	x		x	x	x
01.5	1.5	250	0.0712	0.800	x		x	x	x	
002.	2	250	100A@250Vac 10KA@125Vac 10KA@125Vdc	0.0497	1.500	x		x	x	x
02.5	2.5	250		0.0372	2.680	x		x	x	x
003.	3	250		0.0317	4.620	x		x	x	x
03.5	3.5	250		0.0265	6.700	x		x	x	x
004.	4	125	100A@250Vac 500A@125Vac	0.0240	9.400		x	x	x	x
005.	5	125		0.0186	17.0		x	x	x	x
005.	5	250		0.0186	17.0		x	x		x
006.	6	125	500A@125Vac	0.0154	22.1		x	x	x	x
007.	7	125		0.0130	40.0		x	x	x	x
008.	8	125		0.0107	56.0		x	x	x	x
010.	10	125		0.0075	116.0		x	x	x	x

* 10A with 500A @ 125 Vdc internal breaking capacity testing.

Temperature Derating Curve

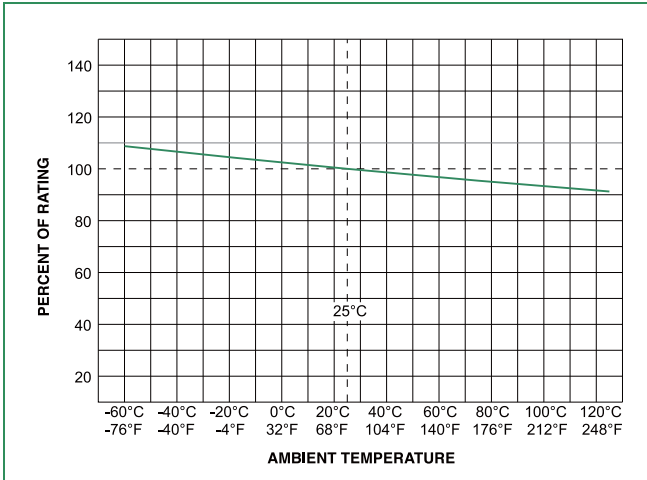

Average Time Current Curves

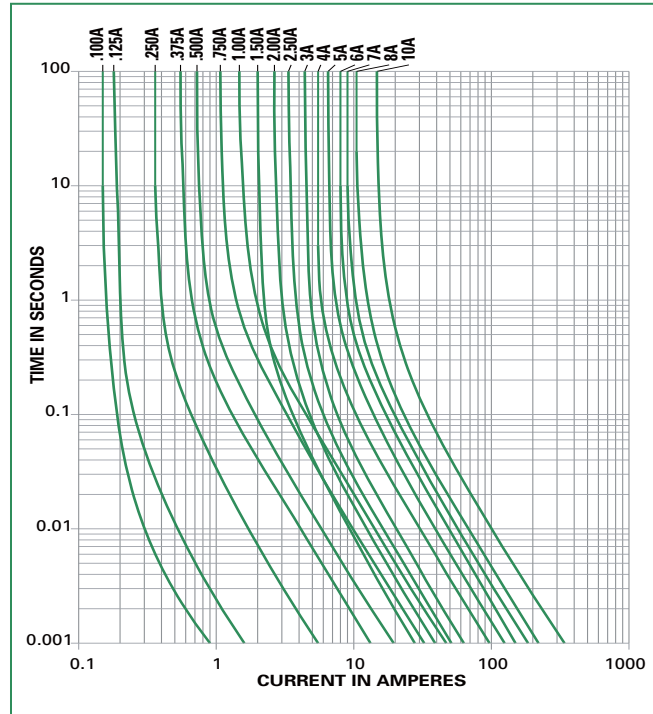

Soldering Parameters - Wave Soldering

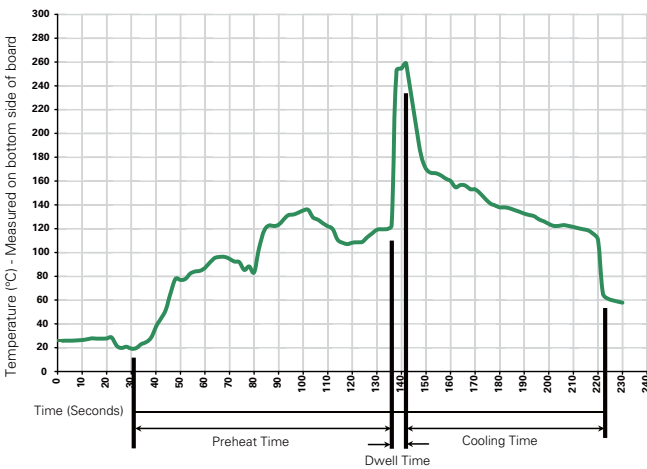

Recommended Process Parameters:

Wave Parameter	Lead-Free Recommendation
Preheat:	
(Depends on Flux Activation Temperature)	(Typical Industry Recommendation)
Temperature Minimum:	100° C
Temperature Maximum:	150° C
Preheat Time:	60-180 seconds
Solder Pot Temperature:	260° C Maximum
Solder Dwell Time:	2-5 seconds

Recommended Hand-Solder Parameters:

Solder Iron Temperature: 350° C +/- 5° C
 Heating Time: 5 seconds max.

Note: These devices are not recommended for IR or Convection Reflow process.

Product Characteristics

Materials	Body : Glass Cap : Nickel-plated brass Leads: Tin-plated Copper
Terminal Strength	MIL-STD-202F Method 211A, Test Condition A
Solderability	Reference IEC 6012/Second Edition 2003-01 Annex A
Product Marking	Cap1 : Brand logo, current and Voltage Ratings Cap2 : Series and Agency approval Mark

Operating Temperature:	-55°C to +125°C
Thermal Shock:	MIL-STD-202F, Method 107G, Test Condition B (5 Cycles -65°C to +125°C).
Vibration	MIL-STD-202F, Method 201A
Humidity	MIL-STD-202F Method 103B, Test Condition A: High RH (95%) and elevated temp (40°C) for 240 hours
Salt Spray	MIL-STD-202F Method 101D, Test Condition B

Dimensions

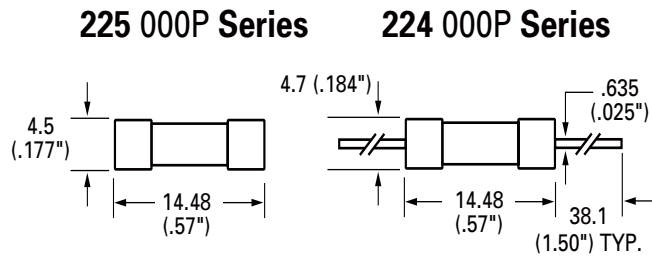

Part Numbering System

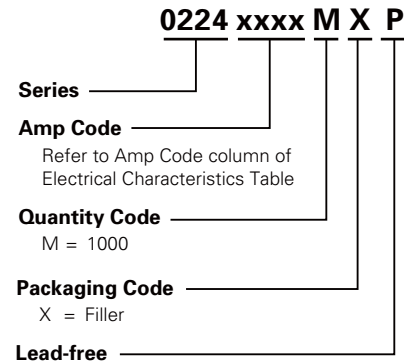

Packaging

Packaging Option	Packaging Specification	Quantity	Quantity & Packaging Code	Taping Width
224 Series				
Bulk	N/A	5	VX	N/A
Bulk	N/A	5	VXU	N/A
Bulk	N/A	100	HX	N/A
Bulk	N/A	100	HXU	N/A
Bulk	N/A	1000	MX	N/A
Bulk	N/A	1000	MX250U	N/A
Bulk	N/A	1000	MXF16	N/A
Bulk	N/A	1000	MXF23	N/A
Bulk	N/A	1000	MXU	N/A
Reel and Tape	EIA 296-E	1500	DRT1	T1=52mm (2.062")
Reel and Tape	EIA 296-E	1500	DRT1U	T1=52mm (2.062")
Reel and Tape	EIA 296-E	1500	DRT2	T2=63mm (2.500")
Reel and Tape	EIA 296-E	1500	DRT3	T3=73mm (2.874")
Reel and Tape	EIA 296-E	2500	ERT1	T1=52mm (2.062")
Reel and Tape	EIA 296-E	2500	ERT2	T2=63mm (2.500")
Reel and Tape	EIA 296-E	2500	ERT3	T3=73mm (2.874")
Bulk	N/A	1000	MX50LE	N/A
225 Series				
Bulk	N/A	5	VX	N/A
Bulk	N/A	5	VXU	N/A
Bulk	N/A	100	HX	N/A
Bulk	N/A	100	HXU	N/A
Bulk	N/A	1000	MX	N/A
Bulk	N/A	1000	MXU	N/A

RoHS  **229/230 Series** Lead-Free 2AG, Slo-Blo® Fuse and Indicating Slo-Blo® Fuse     







Description

The 2AG Slo-Blo® Fuses are available in cartridge form or with axial leads. 2AG Fuses provide the same performance characteristics as their 3AG counterpart, while occupying one-third the space.

The fuse catalog number with the suffix "S" instantly identifies itself upon opening by showing a discoloration of its glass body. Guesswork and time consuming circuit testing are eliminated. This unique design offers the same quality performance characteristics as the standard 2AG Slo-Blo® fuse design. When ordering the 2AG Indicating Slo-Blo® Fuse, an 'S' is required after the catalog number.

Agency Approvals

Agency	Agency File Number	Ampere Range
	E10480	250mA - 3.5A
	LR 29862	250mA - 7A
	E10480	4A - 7A
	NBK210405 - E10480D/F/G/H	1A - 7A
		250mA - 7A

Features

- In accordance with UL Standard 248-14
- Fuses are boradwashable in most solvents
- RoHS compliant and Lead-free
- Available in cartridge and axial lead form and with various lead forming dimensions
- Sleeved fuses are available

Applications

- Standard 229/230 series meets the demanding requirements of the Telecom Industry.
- These fuses combine conventional overcurrent protection with ability to withstand high current, short duration pulses which complies to short circuit requirements of UL 1459 for Telecom equipments.

Electrical Characteristics for Series

% of Ampere Rating	Opening Time
100%	4 hours, Minimum
135%	1 hour, Maximum
200%	3 sec.onds, Maximum
	20 seconds, Maximum

229/230 Series

Electrical Characteristic Specification by Item

Amp Code	Ampere Rating (A)	Voltage Rating (V)	Interrupting Rating	Nominal Cold Resistance (Ohms)	Nominal Melting I ² t (A ² sec)	Agency Approvals				
						UL	RU	PS E	SP	CE
.250	0.25	250	35A@250Vac 10KA@125Vac 10KA@125Vdc 80A@310Vac	2.4300	0.216	x			x	x
.350	0.35	250		1.3100	0.490	x			x	x
.375	0.375	250		1.1685	0.580	x			x	x
.500	0.5	250		0.6935	1.16	x			x	x
.600	0.6	250		0.4805	1.75	x			x	x
.750	0.75	250		0.3430	2.95	x			x	x
.800	0.8	250		0.3060	3.45	x			x	x
001.	1	250		0.2120	5.64	x		x	x	x
1.25	1.25	250	100A@250Vac 10KA@125Vac 10KA@125Vdc 80A@310Vac	0.1460	9.80	x		x	x	x
01.5	1.5	250		0.1077	15.0	x		x	x	x
002.	2	250		0.0698	30.0	x		x	x	x
2.25	2.25	250		0.0567	39.0	x		x	x	x
02.5	2.5	250		0.0502	50.0	x		x	x	x
003.	3	250		0.0383	77.0	x		x	x	x
03.5	3.5	250	100A@250Vac 10KA@125Vac 10KA@125Vdc	0.0312	110.0	x		x	x	x
004.	4	125	400A@125Vac 400A@125Vdc	0.0258	148.0		x	x	x	x
005.	5	125		0.0186	267		x	x	x	x
006.	6	125		0.0141	380		x	x	x	x
007.	7	125		0.0116	464		x	x	x	x

Description

Standard 229 and 230 Series Slo-Blo fuses meet the demanding requirements of the Telecom industry. These fuses combine conventional overcurrent protection with the ability to withstand high current, short duration pulses. These fuses comply with the short circuit requirements of UL 1459 for telephone equipment. Insulating sleeve option available.

Features

In accordance with underwriter's Laboratories Standard UL 248-14.
 Fuses are boardwashable in most solvents.
 Available in cartridge and axial lead form and with various lead forming dimensions.
 RoHS compliant and lead-free.
 Available in ratings from 250mA to 1.25A.

Applications

Used for the telecom industry.

Surge Withstand Specificatons

Peak Withstand Current(I_p): These fuses will withstand 50 repetitions of a double exponential impulse wave having peak currents(I_p) and peak voltages as listed.

Amp Code	Ampere Rating (A)	Interrupting Rating	Nominal Cold Resistance (Ohms)	Nominal Melting I ² t (A ² sec)	10 x 160 μs 1500V	10 x 560 μs 800V	10 x 1000 μs 1000V
.250	0.25	60A@600Vac 40A@600Vac 7A@600Vac 2.2A@600Vac	2.4300	0.216	23.0A	16.6A	12.4A
.350	0.35		1.3100	0.490	34.0A	25.8A	19.3A
.375	0.375		1.1685	0.580	40.0A	25.4A	19.0A
.500	0.5		0.6935	1.16	60.0A	37.7A	28.2A
.600	0.6		0.4805	1.75	71.0A	47.2A	35.3A
.750	0.75		0.3430	2.95	91.0A	65.5A	49.0A
.800	0.8		0.3060	3.45	104.0A	68.9A	51.6A
001.	1		0.2120	5.64	130A	88.6A	66.3A
1.25	1.25*		0.1460	9.80	162.0A	118.1A	100.0A

* 500A peak, 2500V, 2 x 10 microseconds, 20 repetitions

Temperature Derating Curve

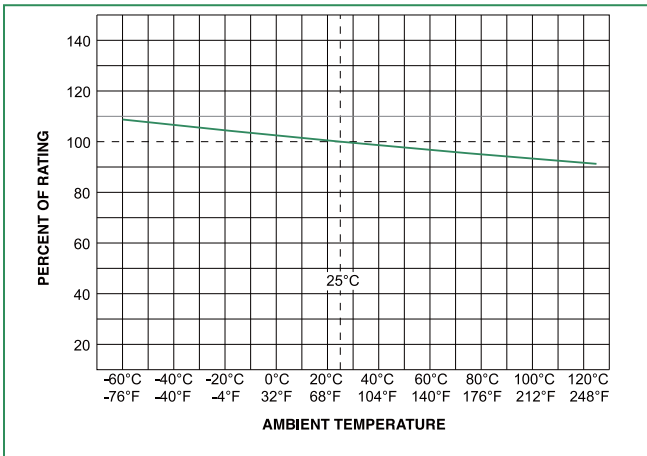

Average Time Current Curves

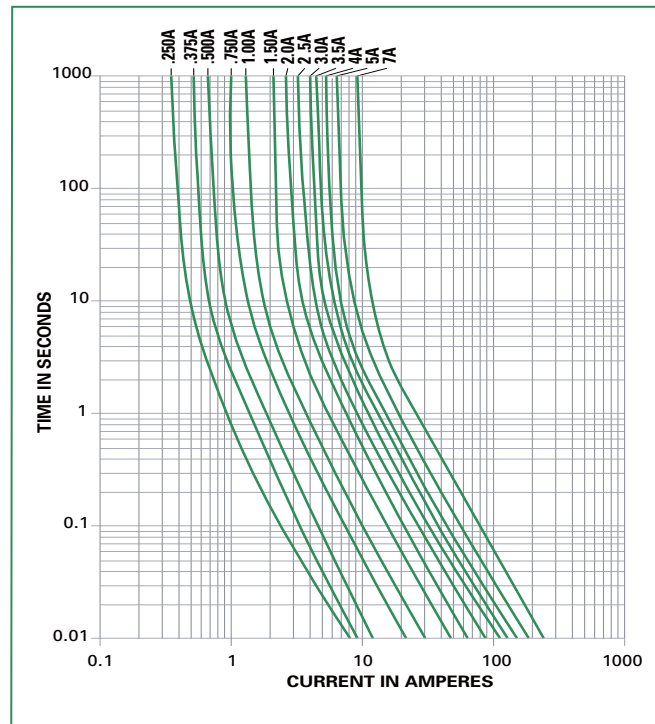

Soldering Parameters - Wave Soldering

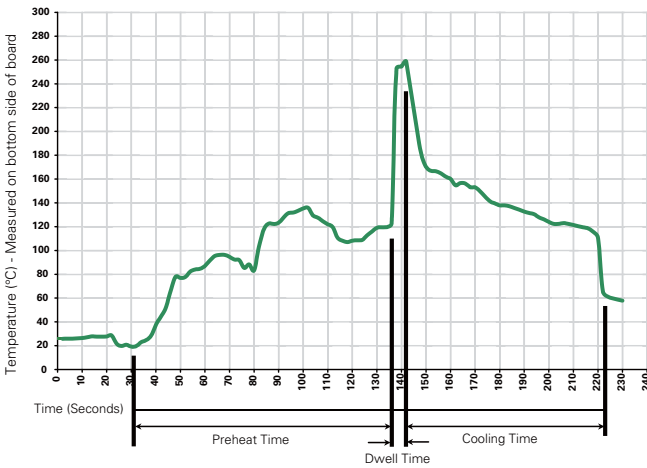

Recommended Process Parameters:

Wave Parameter	Lead-Free Recommendation
Preheat: (Depends on Flux Activation Temperature)	(Typical Industry Recommendation)
Temperature Minimum:	100° C
Temperature Maximum:	150° C
Preheat Time:	60-180 seconds
Solder Pot Temperature:	260° C Maximum
Solder Dwell Time:	2-5 seconds

Recommended Hand-Solder Parameters:

Solder Iron Temperature: 350° C +/- 5° C
 Heating Time: 5 seconds max.

Note: These devices are not recommended for IR or Convection Reflow process.

Product Characteristics

Materials	Body: Glass Cap: Nickel-plated brass Leads: Tin-plated Copper
Terminal Strength	MIL-STD-202G, Method 211A, Test Condition A
Solderability	Reference IEC 60127 Second Edition 2003-01 Annex A
Product Marking	Cap1: Brand logo, current and voltage ratings Cap2: Series and agency approval marks

Operating Temperature	-55°C to +125°C
Thermal Shock	MIL-STD-202G, Method 107G, Test Condition B: (5 cycles -65°C to 125°C)
Vibration	MIL-STD-202G, Method 201A
Humidity	MIL-STD-202G, Method 103B, Test Condition A: High RH (95%) and Elevated temperature(40°C) for 240 hours
Salt Spray	MIL-STD-202G, Method 101D, Test Condition B

Dimensions

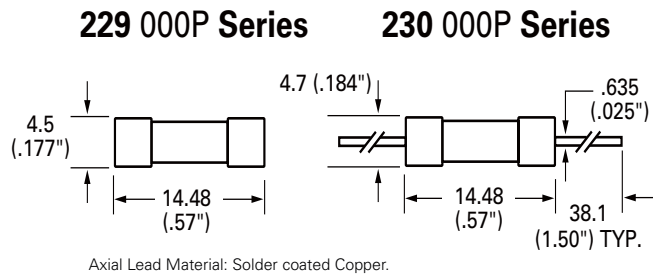

Part Numbering System

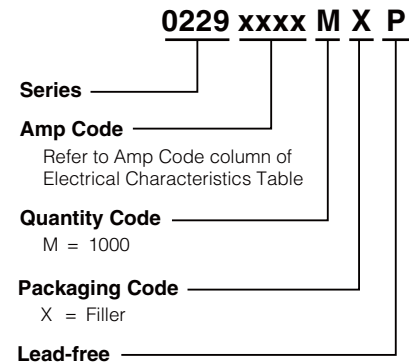

Packaging

Packaging Option	Packaging Specification	Quantity	Quantity & Packaging Code	Taping Width
229 Series				
Bulk	N/A	5	VX	N/A
Bulk	N/A	5	VXS	N/A
Bulk	N/A	100	HX	N/A
Bulk	N/A	100	HXS	N/A
Bulk	N/A	1000	MX	N/A
Bulk	N/A	1000	MXS	N/A
230 Series				
Bulk	N/A	5	VX	N/A
Bulk	N/A	5	VXS	N/A
Bulk	N/A	100	HX	N/A
Bulk	N/A	100	HXS	N/A
Bulk	N/A	1000	MX	N/A
Bulk	N/A	1000	MXE	N/A
Bulk	N/A	1000	MXF1	N/A
Bulk	N/A	1000	MXF16	N/A
Bulk	N/A	1000	MXF16O	N/A
Bulk	N/A	1000	MXF17	N/A
Bulk	N/A	1000	MXF17O	N/A
Bulk	N/A	1000	MXF23	N/A
Bulk	N/A	1000	MXF23O	N/A
Bulk	N/A	1000	MXF32	N/A
Bulk	N/A	1000	MXO	N/A
Bulk	N/A	1000	MXS	N/A
Reel and Tape	EIA 296-E	1500	DRT2	T2=63mm (2.500")
Reel and Tape	EIA 296-E	1500	DRT2S	T2=63mm (2.500")
Reel and Tape	EIA 296-E	1500	DRT4	N/A
Reel and Tape	EIA 296-E	2500	ERT2	T2=63mm (2.500")
Reel and Tape	EIA 296-E	2500	ERT2S	T2=63mm (2.500")
Reel and Tape	EIA 296-E	1000	MRT1E	T1=52mm (2.062")
Reel and Tape	EIA 296-E	1500	DAT1	T1=52mm (2.062")
Reel and Tape	EIA 296-E	1500	DAT1O	T1=52mm (2.062")
Reel and Tape	EIA 296-E	1500	DRT1	T1=52mm (2.062")
Reel and Tape	EIA 296-E	1500	DRT1S	T1=52mm (2.062")
Reel and Tape	EIA 296-E	1500	DRT1SS	T1=52mm (2.062")
Reel and Tape	EIA 296-E	1500	DRT3	T3=73mm (2.874")
Reel and Tape	EIA 296-E	1500	DRT3S	T3=73mm (2.874")
Reel and Tape	EIA 296-E	2500	ERT1	T1=52mm (2.062")
Reel and Tape	EIA 296-E	2500	ERT1S	T1=52mm (2.062")
Reel and Tape	EIA 296-E	2500	ERT3	T3=73mm (2.874")
Reel and Tape	EIA 296-E	2500	ERT3S	T3=73mm (2.874")



Description

5x20mm fast-acting glass body cartridge fuse designed to IEC specification.

Features

- Designed to International (IEC) Standards for use globally
- Meets the IEC 60127-2, Sheet 2
- specification for fast-acting fuses
- Available in cartridge and axial lead form
- RoHS compliant and lead-free

Applications

Used as supplementary protection in appliance or utilization equipment to provide individual protection for components or internal circuits.

Agency Approvals

Agency	Agency File Number	Ampere Range
	Cartridge Certificates: NBK120802-E10480 A&C Leaded Certificates: NBK120802-E10480 B&D	1A – 5A 6.3A – 15A 1A – 5A 6.3A – 15A
	Certificates: 2002010207007600 2002010207007599	32mA – 800mA 1A – 6.3A
	Certificates: SU05001-3004 SU05001-2005 SU05001-2006 SU05001-2007	32mA – 40mA 50mA – 315mA 400mA – 6.3A 8A & 10A
	E10480 JDYX2	32mA – 6.3A
	File: 029862 Acc. Class: LR1422-30	
	License: KM41462	400mA – 6.3A
	File: 948103, 915516, 304518 & 304555	32mA – 6.3A
	License: 40014645	32mA – 6.3A, 8A*, 10A*
	License: 40016647	15A*
		32mA – 15A

*Approval for cartridge versions only

Electrical Characteristics for Series

% of Ampere Rating	Ampere Rating	Opening Time
150%	32mA-100mA	60 minutes, Minimum
	125mA-6.3A	60 minutes, Minimum
	8A-15A	30 minutes, Minimum
210%	32mA-100mA	30 minutes, Maximum
	125mA-6.3A	30 minutes, Maximum
	8A-15A	30 minutes, Maximum
275%	32mA-100mA	0.01 sec., Min.; .5 sec. Max.
	125mA-6.3A	0.05 sec., Min.; 2 sec. Max.
	8A-15A	0.05 sec., Min.; 2 sec. Max.
400%	32mA-100mA	.003 sec., Min.; 0.1 sec. Max.
	125mA-6.3A	.01 sec., Min.; 0.3 sec. Max.
	8A-15A	.01 sec., Min.; 0.4 sec. Max.
1000%	32mA-100mA	.02 second, Maximum
	125mA-6.3A	.02 second, Maximum
	8A-15A	.04 second, Maximum

Electrical Characteristic Specifications by Item

Amp Code	Amp Rating (A)	Voltage Rating (V)	Interrupting Rating	Nominal Cold Resistance (Ohms)	Nominal Melting I ² t (A ² sec)	Nominal Voltage Drop at Rated Current (mV)	Nominal Power Dissipation At Rated Current (W)	Agency Approvals									
								UL	CCC	PS	RU	SP	S	CE	D'E	UL	UL
.032	0.032	250	35A@250Vac	262.2000	0.00006	10000	1.6	x	x		x	x	x	x	x		
.040	0.04	250		183.1500	0.00008	8000	1.6	x	x		x	x	x	x	x		
.050	0.05	250		15.2000	0.00019	7000	1.6	x	x		x	x	x	x	x		
.063	0.063	250		10.4500	0.00056	5000	1.6	x	x		x	x	x	x	x		
.080	0.08	250		7.8900	0.00083	4000	1.6	x	x		x	x	x	x	x		
.100	0.1	250		5.6965	0.00450	3500	1.6	x	x		x	x	x	x	x		
.125	0.125	250		3.8200	0.00478	2000	1.6	x	x		x	x	x	x	x		
.160	0.16	250		2.5250	0.01000	2000	1.6	x	x		x	x	x	x	x		
.200	0.2	250		1.7000	0.02000	1700	1.6	x	x		x	x	x	x	x		
.250	0.25	250		1.2325	0.04000	1400	1.6	x	x		x	x	x	x	x		
.315	0.315	250		0.8800	0.11000	1300	1.6	x	x		x	x	x	x	x		
.400	0.4	250		0.2770	0.12500	1200	1.6	x	x		x	x	x	x	x	x	
.500	0.5	250		0.2065	0.21500	1000	1.6	x	x		x	x	x	x	x	x	
.630	0.63	250		0.1900	0.41000	650	1.6	x	x		x	x	x	x	x	x	
.800	0.8	250		0.1203	0.85000	240	1.6	x	x		x	x	x	x	x	x	
001.	1	250		0.0964	1.04500	200	1.6	x	x	x	x	x	x	x	x	x	
1.25	1.25	250		0.0701	2.23000	200	1.6	x	x	x	x	x	x	x	x	x	
016	1.6	250		0.0528	4.61500	190	1.6	x	x	x	x	x	x	x	x	x	
002.	2	250		0.0416	5.73000	170	1.6	x	x	x	x	x	x	x	x	x	
02.5	2.5	250		0.0334	9.46000	170	1.6	x	x	x	x	x	x	x	x	x	
3.15	3.15	250	0.0224	17.72000	150	2.5	x	x	x	x	x	x	x	x	x		
004.	4	250	40A@250Vac	0.0165	29.16500	130	2.5	x	x	x	x	x	x	x	x		
005.	5	250	50A@250Vac	0.0137	42.79500	130	2.5	x	x	x	x	x	x	x	x		
06.3	6.3	250	63A@250Vac	0.0095	62.46500	130	2.5	x	x	x	x	x	x	x	x		
008.	8	250	80A@250Vac	0.0068	198.16000	130	4	x		x			x	x*			
010.	10	250	100A@250Vac	0.0063	217.63500	130	4	x		x			x	x*			
015.	15	250	150A@250Vac	0.0040	607.13500	130	4			x			x	x*			

* Approval for cartridge versions only.

Temperature Derating Curve

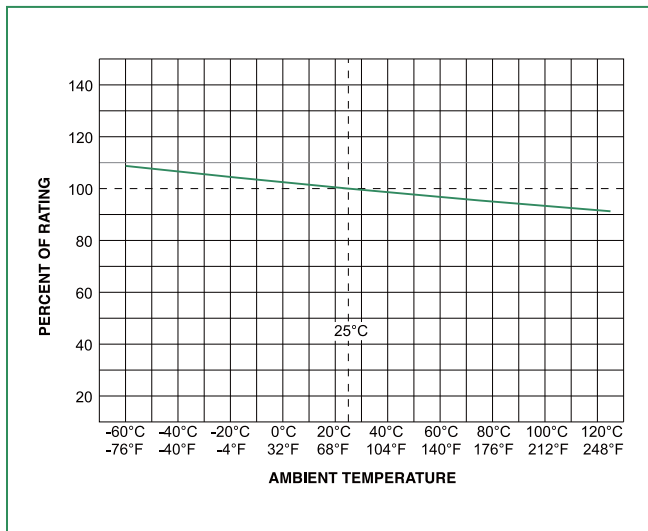

Average Time Current Curves



Soldering Parameters - Wave Soldering



Recommended Process Parameters:

Wave Parameter	Lead-Free Recommendation
Preheat: (Depends on Flux Activation Temperature) (Typical Industry Recommendation)	
Temperature Minimum:	100° C
Temperature Maximum:	150° C
Preheat Time:	60-180 seconds
Solder Pot Temperature:	260° C Maximum
Solder Dwell Time:	2-5 seconds

Recommended Hand-Solder Parameters:

Solder Iron Temperature: 350° C +/- 5° C
 Heating Time: 5 seconds max.

Note: These devices are not recommended for IR or Convection Reflow process.

Product Characteristics

Material	Body: Glass Cap: Nickel-plated brass Leads: Tin-plated Copper
Terminal Strength	MIL-STD-202G, Method 211A, Test Condition A
Solderability	Reference IEC 60127 Second Edition 2003-01 Annex A
Product Marking	Cap1: Brand logo, current and voltage ratings Cap2: Agency approval marks
Packaging	Available in Bulk (M=1000 pcs/pkg) or on Tape/Reel (MRET1=1000 pcs/reel)

Operating Temperature	-55°C to +125°C
Thermal Shock	MIL-STD-202G, Method 107G, Test Condition B: (5 cycles -65°C to +125°C)
Vibration	MIL-STD-202G, Method 201A
Humidity	MIL-STD-202G, Method 103B, Test Condition A. high RH (95%) and elevated temperature (40°C) for 240 hours.
Salt Spray	MIL-STD-202G, Method 101D, Test Condition B

Dimensions

0217 000P



0217.032 XEP
to
0217.315 XEP



0217.400 XEP
to
0217015 XEP



All dimensions in mm

Notes:

- * Ratings above 6.3A have 0.8 mm dia lead

Part Numbering System



Packaging

Packaging Option	Packaging Specification	Quantity	Quantity & Packaging Code	Taping Width
Bulk	N/A	1000	MX	N/A
Bulk	N/A	1000	MXE	N/A
Reel and Tape	EIA 296-E	1000	MRET1	T1=52mm (2.062")

RoHS  **218 Series, 5 x 20 mm, Time-Lag (Slo-Blo®) Fuse**          



Description

5x20mm Time-Lag glass body cartridge fuse designed to IEC specification.

Features

- Designed to International (IEC) Standards for use globally
- Meets the IEC 60127-2, Sheet 3 specification for Time-Lag fuses
- Available in cartridge and axial lead form
- RoHS compliant and lead-free

Applications

Used as supplementary protection in appliance or utilization equipment to provide individual protection for components or internal circuits.

Agency Approvals

Agency	Agency File Number	Ampere Range
	Cartridge Certificates: NBK120802-E10480 A&C Leaded Certificates: NBK120802-E10480 B&D	1A – 5A 6.3A – 15A
	Certificates: 2002010207007596	32mA – 6.3A
	Certificates: SU05001-3005 SU05001-2008 SU05001-2009	32mA – 40mA 50mA – 800mA 1A – 10A
	Recognised File: E10480 Guide: JDYX2	32mA – 16A
	File: 029862 Acc. Class: LR1422-30	32mA – 15A
	License: KM41462	80mA – 6.3A
	File: 9850004, 9843043, 811742, 304650, 416270	32mA – 6.3A
	License: 40013496	32mA – 10A
	License: 40016604	15A*
		32mA – 16A

* Approval for Cartridge versions only

Electrical Characteristics

% of Ampere Rating	Ampere Rating	Opening Time
150%	32mA–100mA	60 minutes, Minimum
	125mA-6.3A	60 minutes, Minimum
	8A-15A	30 minutes, Minimum
210%	32mA-100mA	120 sec., Maximum
	125mA-6.3A	120 sec., Maximum
	8A-15A	120 sec., Maximum
275%	32mA-100mA	200 ms., Min.; 10 sec. Max.
	125mA-6.3A	600 ms., Min.; 10 sec. Max.
	8A-15A	600 ms., Min.; 10 sec. Max.
400%	32mA-100mA	40 ms., Min.; 3 sec. Max.
	125mA-6.3A	150 ms., Min.; 3 sec. Max.
	8A-15A	150 ms., Min.; 3 sec. Max.
1000%	32mA-100mA	10 ms., Min.; 300 ms. Max.
	125mA-6.3A	20 ms., Min.; 300 ms. Max.
	8A-15A	20 ms., Min.; 300 ms. Max.

Electrical Characteristics

Amp Code	Amp Rating (A)	Voltage Rating (V)	Interrupting Rating	Nominal Cold Resistance (Ohms)	Nominal Melting I ² t (A ² sec)	Nominal Voltage Drop at Rated Current (mV)	Nominal Power Dissipation At Rated Current (W)	Agency Approvals									
.032	0.032	250	35 A @ 250 VAC	48.2580	0.01100	5000	1.6	x	x		x	x	x	x	x		
.040	0.04	250		31.8620	0.01100	4000	1.6	x	x		x	x	x	x	x		
.050	0.05	250		21.2920	0.01700	3500	1.6	x	x		x	x	x	x	x		
.063	0.063	250		14.2680	0.02800	3000	1.6	x	x		x	x	x	x	x		
.080	0.08	250		9.0700	0.07500	2500	1.6	x	x		x	x	x	x	x		
.100	0.1	250		6.0180	0.07900	2000	1.6	x	x		x	x	x	x	x		
.125	0.125	250		4.2000	0.1465	1900	1.6	x	x		x	x	x	x	x		
.160	0.16	250		3.7000	0.14400	1500	1.6	x	x		x	x	x	x	x		
.200	0.2	250		1.6000	0.3410	1300	1.6	x	x		x	x	x	x	x		
.250	0.25	250		1.0495	0.5405	1100	1.6	x	x		x	x	x	x	x		
.315	0.315	250		0.8475	1.1100	1000	1.6	x	x		x	x	x	x	x		
.400	0.4	250		0.5350	1.3250	900	1.6	x	x		x	x	x	x	x		
.500	0.5	250		0.3700	2.8250	300	1.6	x	x		x	x	x	x	x		
.630	0.63	250		0.2750	4.6750	250	1.6	x	x		x	x	x	x	x		
.800	0.8	250		0.0813	3.370	150	1.6	x	x		x	x	x	x	x		
001.	1	250		0.0613	6.730	150	1.6	x	x	x	x	x	x	x	x		
1.25	1.25	250		0.0446	12.650	150	1.6	x	x	x	x	x	x	x	x		
01.6	1.6	250		0.0336	23.350	150	1.6	x	x	x	x	x	x	x	x		
002.	2	250		0.0293	14.450	150	1.6	x	x	x	x	x	x	x	x		
02.5	2.5	250		0.0219	23.250	120	1.6	x	x	x	x	x	x	x	x		
3.15	3.15	250	0.0173	38.150	100	1.6	x	x	x	x	x	x	x	x			
004.	4	250	40 A @ 250 VAC	0.0129	69.10	100	1.6	x	x	x	x	x	x	x			
005.	5	250	50 A @ 250 VAC	0.0104	111.00	100	1.6	x	x	x	x	x	x	x			
06.3	6.3	250	63 A @ 250 VAC	0.0076	198.50	100	1.6	x	x	x	x	x	x	x			
008.	8	250	80 A @ 250 VAC	0.0059	341.50	100	4	x		x	x	x		x			
010.	10	250	100 A @ 250 VAC	0.0045	568.00	100	4	x		x	x	x		x			
12.5	12.5	250	63 A @ 250 VAC	0.0034	889.00	100	4			x	x						
015.	15	250	100 A @ 250 VAC	0.0028	1405.00	100	4			x	x	x		x*			
016.	16	250	63 A @ 250 VAC	0.0021	1955.00	100	4				x			x			

* Approval for cartridge versions only

Temperature Derating Curve

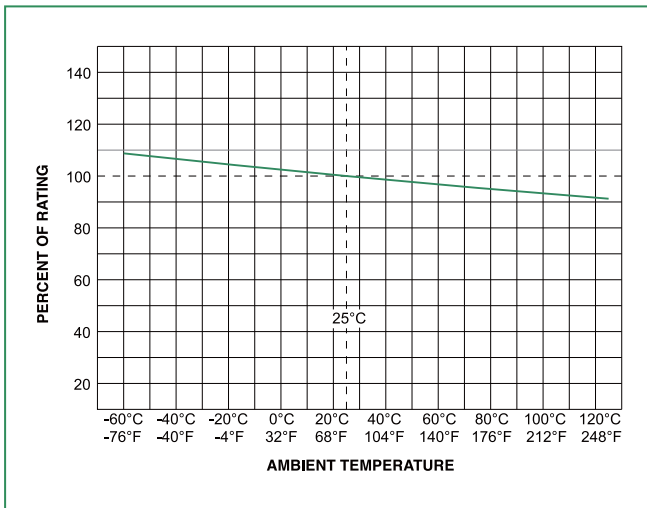

Average Time Current Curves

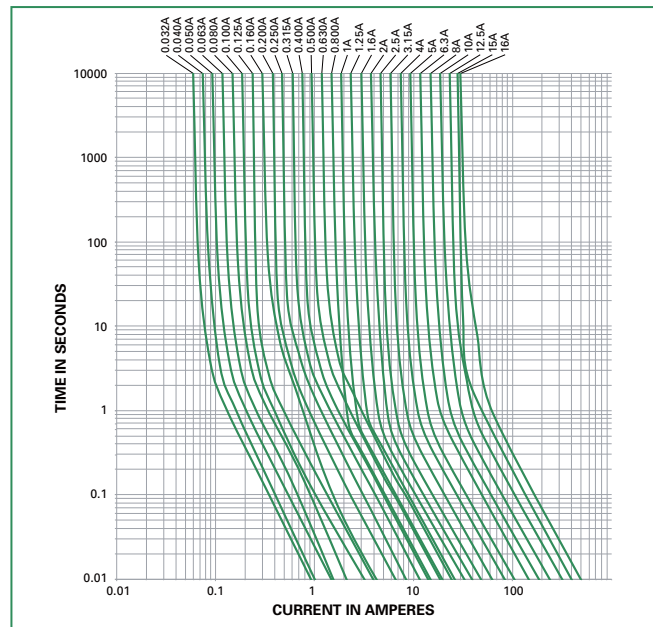

Soldering Parameters - Wave Soldering

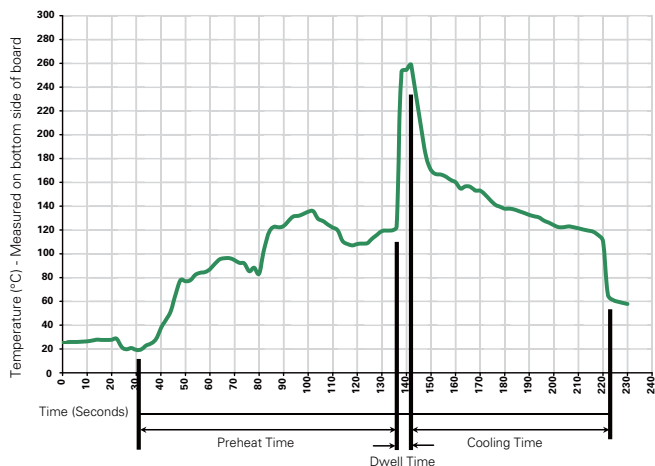

Recommended Process Parameters:

Wave Parameter	Lead-Free Recommendation
Preheat: (Depends on Flux Activation Temperature) (Typical Industry Recommendation)	
Temperature Minimum:	100° C
Temperature Maximum:	150° C
Preheat Time:	60-180 seconds
Solder Pot Temperature:	260° C Maximum
Solder Dwell Time:	2-5 seconds

Recommended Hand-Solder Parameters:

Solder Iron Temperature: 350° C +/- 5° C
 Heating Time: 5 seconds max.

Note: These devices are not recommended for IR or Convection Reflow process.

Product Characteristics

Material	Body: Glass Cap: Nickel-plated Brass Leads: Tin-plated Copper
Terminal Strength	MIL-STD-202G, Method 211A, Test Condition A
Solderability	Reference IEC 60127 Second Edition 2003-01 Annex A
Product Marking	Cap1: Brand logo, current and voltage ratings Cap2: Agency approval marks
Packaging	Available in Bulk (M=1000 pcs/pkg) or on Tape/Reel (MRET1=1000 pcs/reel)

Operating Temperature	-55°C to +125°C
Thermal Shock	MIL-STD-202G, Method 107G, Test Condition B (5 cycles, -65°C to +125°C)
Vibration	MIL-STD-202G, Method 201A
Humidity	MIL-STD-202G, Method 103B, Test Condition A (High RH (95%) and elevated temperature (40°C) for 240 hours)
Salt Spray	MIL-STD-202G, Method 101D, Test Condition B

Dimensions

0218 000P

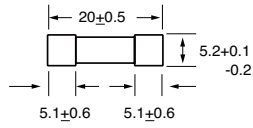

**0218.032 XEP
to
0218.100XEP**

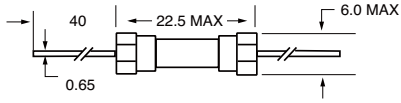

**0218.125 XEP
to
0218016. XEP**

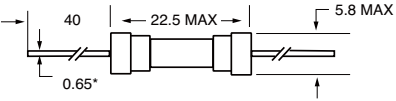

All dimensions in mm

Notes:
 * Ratings above 6.3A
 have 0.8 mm dia lead

Part Numbering System

0218 xxxx M X E P

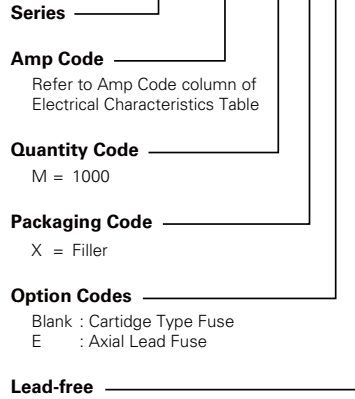

Packaging

Packaging Option	Packaging Specification	Quantity	Quantity & Packaging Code	Taping Width
Bulk	N/A	1000	MX	N/A
Bulk	N/A	1000	MXE	N/A
Reel and Tape	EIA 296-E	1000	MRET1	T1=52mm (2.062")

RoHS  **213 Series, 5 x 20 mm, Time-Lag (Slo-Blo®) Fuse**



Description

5x20mm time-Lag surge withstand glass body cartridge fuse designed to IEC specification.









Features

- Designed to International (IEC) Standards for use globally
- Available in cartridge and axial lead form
- Meets the IEC 60127-2, Sheet 3 specification for time-Lag fuses
- RoHS compliant and lead-free.

Applications

Used as supplementary protection in appliance or utilization equipment to provide individual protection for components or internal circuits.









Agency Approvals

Agency	Agency File Number	Ampere Range
	Cartridge Certificates: NBK120802-E10480 A&C Leaded Certificates: NBK120802-E10480 B&D	1A – 5A 6.3A
	Certificates: 2002010207007597 2003010207045592	200mA – 6.3A 5A
	Recognised File: E10480 Guide: JDYX2	200mA – 6.3A
	File: 029862 Acc. Class: LR1422-30	
	License: KM41462	
	File: 915515,811747	
	License: 40015638	
		200mA – 6.3A

Electrical Characteristic for Series

% of Ampere Rating	Ampere Rating	Opening Time
150%	All Ratings	60 minutes, Minimum
210%		2 minutes, Maximum
275%		0.6 sec., Min.; 10 sec. Max.
400%		.15 sec., Min.; 3 sec. Max.
1000%		0.02 sec., Min.; 0.3 sec. Max.

Electrical Characteristic Specifications by Item

Amp Code	Ampere Rating	Voltage Rating (V)	Interrupting Rating	Nominal Cold Resistance (Ohms)	Nominal Melting I ² t (A ² sec)	Nominal Voltage Drop (mV)	Nominal Power Dissipation (W)	Agency Approvals									
																	
.200	0.2	250	35A@250Vac	1.6000	0.22500	1500	1.6	x		x	x	x	x	x	x	x	
.250	0.25	250		1.0495	0.55500	1300	1.6	x		x	x	x	x	x	x	x	x
.315	0.315	250		0.8475	1.14000	1100	1.6	x		x	x	x	x	x	x	x	x
.400	0.4	250		0.5350	1.36000	1000	1.6	x	x	x	x	x	x	x	x	x	x
.500	0.5	250		0.3700	2.90500	900	1.6	x		x	x	x	x	x	x	x	x
.630	0.63	250		0.2750	4.80000	300	1.6	x		x	x	x	x	x	x	x	x
.800	0.8	250		0.1635	9.42000	250	1.6	x		x	x	x	x	x	x	x	x
001.	1	250		0.1165	19.20000	150	1.6	x	x	x	x	x	x	x	x	x	x
1.25	1.25	250		0.0817	27.15000	150	1.6	x	x	x	x	x	x	x	x	x	x
01.6	1.6	250		0.0551	44.20000	150	1.6	x	x	x	x	x	x	x	x	x	x
002.	2	250		0.0452	92.70500	150	1.6	x	x	x	x	x	x	x	x	x	x
02.5	2.5	250		0.0305	138.00000	120	1.6	x	x	x	x	x	x	x	x	x	x
3.15	3.15	250		0.0231	202.00000	100	1.6	x	x	x	x	x	x	x	x	x	x
004.	4	250		40A@250Vac	0.0170	226.50500	100	1.6	x	x	x	x	x	x	x	x	x
005.	5	250		50A@250Vac	0.0116	314.00000	100	1.6	x	x	x	x	x	x	x	x	x
06.3	6.3	250		63A@250Vac	0.0095	600.00000	100	1.6	x	x	x	x	x	x	x	x	x

Temperature Derating Curve

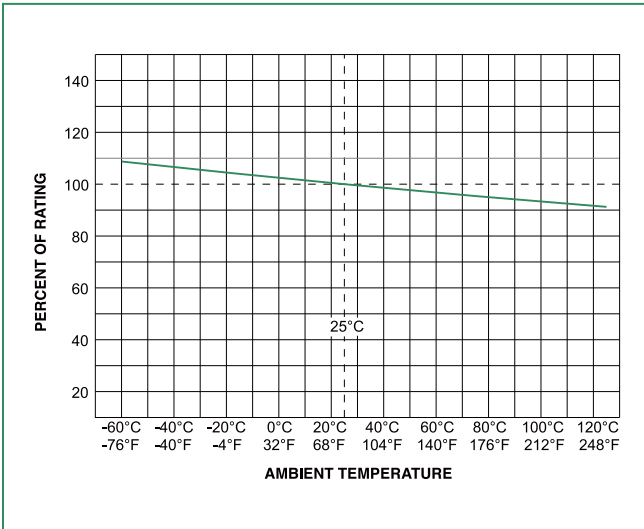

Average Time Current Curves

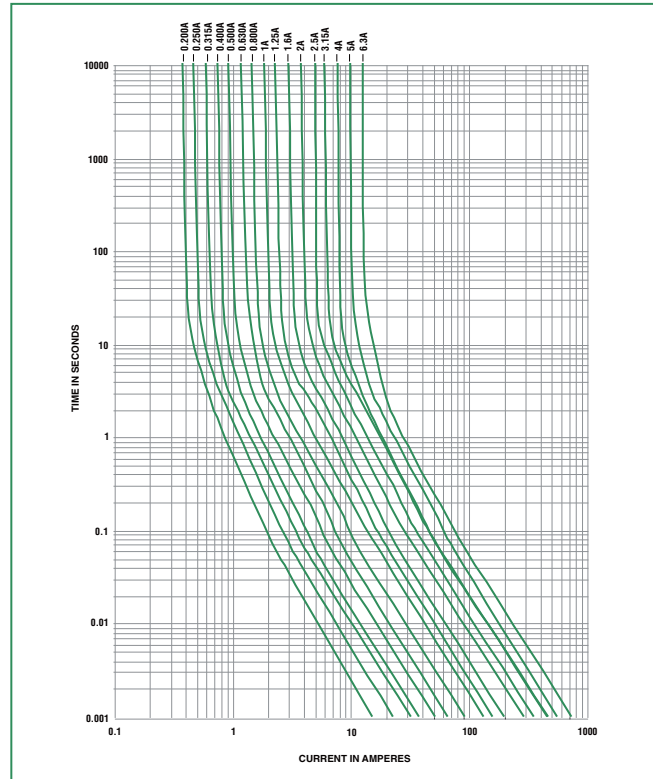

Soldering Parameters - Wave Soldering

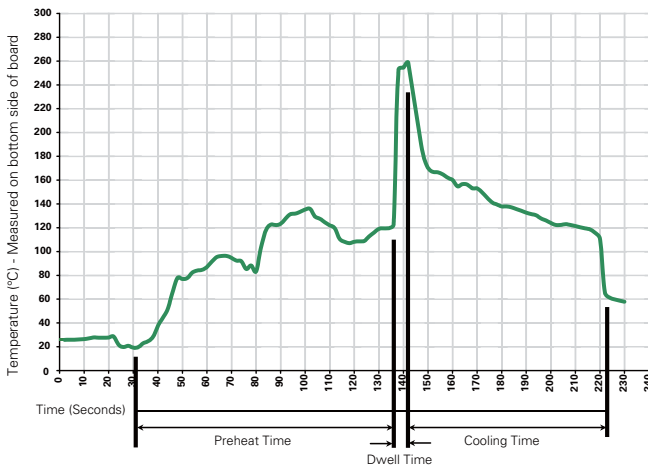

Recommended Process Parameters:

Wave Parameter	Lead-Free Recommendation
Preheat: (Depends on Flux Activation Temperature)	(Typical Industry Recommendation)
Temperature Minimum:	100° C
Temperature Maximum:	150° C
Preheat Time:	60-180 seconds
Solder Pot Temperature:	260° C Maximum
Solder Dwell Time:	2-5 seconds

Recommended Hand-Solder Parameters:

Solder Iron Temperature: 350° C +/- 5° C
 Heating Time: 5 seconds max.

Note: These devices are not recommended for IR or Convection Reflow process.

Product Characteristics

Material	Body: Glass Cap: Nickel-plated brass Leads: Tin-plated Copper
Terminal Strength	MIL-STD-202G, Method 211A, Test Condition A
Solderability	Reference IEC 60127, Second Edition 2003-01, Annex A
Product Marking	Cap1: Brand logo, current and voltage Cap2: Agency approval marks Series
Packaging	Available in Bulk (M=1000 pcs/pkg) or on Tape/Reel (MRET1=1000 pcs/reel)

Operating Temperature	-55°C to +125°C
Thermal Shock	MIL-STD-202G, Method 107G, Test Condition B: (5 cycles -65°C to +125°C)
Vibration	MIL-STD-202G, Method 201A
Humidity	MIL-STD-202G, Method 103B, Test Condition A. High RH (95%) and elevated temperature (40°C) for 240 hours.
Salt Spray	MIL-STD-202G, Method 101D, Test Condition B

Dimensions

0213 000P

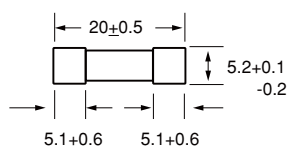

0213 000 XEP

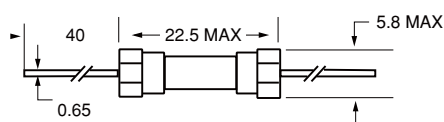

All dimensions in mm

Notes:

* Ratings above 6.3A have 0.8 mm dia lead

Part Numbering System

0213 xxxx M X E P

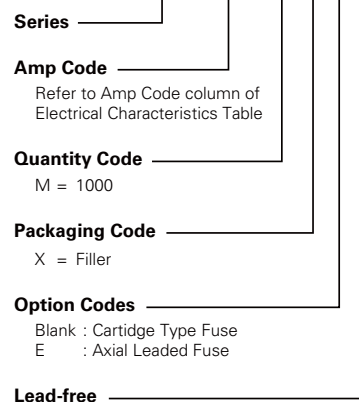

Packaging

Packaging Option	Packaging Specification	Quantity	Quantity & Packaging Code	Taping Width
213 Series				
Bulk	N/A	1000	MX	N/A
Bulk	N/A	1000	MXE	N/A
Reel and Tape	EIA 296-E	1000	MRET1	T1=52mm (2.062")

RoHS **REACH** **219XA Series, 5x20mm, Time-Lag (Slo-Blo®) Fuse**

Description

5x20mm time-Lag glass body cartridge fuse designed to IEC specification









Features

- Designed to International (IEC) Standards for use globally
- Meets the IEC 60127-2, Sheet 6 specification for time-Lag fuses
- Available in cartridge and axial lead form
- RoHS compliant and lead-free

Applications

Used as supplementary protection in appliance or utilization equipment to provide individual protection for components or internal circuits.

Agency Approvals









Agency	Agency File Number	Ampere Range
	Cartridge Certifications: NBK220604-E10480A NBK230604-E10480A Leaded Certifications: NBK220604-E10480B NBK230604-E10480B	1A – 5A 6.3A 1A – 5A 6.3A
	Certifications: 2004010207110266 2003010207079982	125mA – 800mA 1A – 6.3A
	Recognised File: E10480 Guide: JDYX2	40mA – 6.3A
	File and Acc. Class: 029862_0_000	125mA – 6.3A
	License: KM41462	
	File: 604904/604924 402708 310144	40mA – 100mA 125mA – 800mA 1A – 6.3A
	License: 40016080	125mA – 6.3A
		40mA – 6.3A

Electrical Characteristics for Series

% of Ampere Rating	Ampere Rating	Opening Time
150%	40mA – 100mA	1 hours, Minimum
	125mA – 6.3A	1 hours, Minimum
210%	40mA – 100mA	2 minutes, Maximum
	125mA – 6.3A	2 minutes, Maximum
275%	40mA – 100mA	0.2 sec., Min; 10 sec. Max
	125mA – 6.3A	0.6 sec., Min; 10 sec. Max
400%	40mA – 100mA	0.04 sec., Min; 3 sec. Max
	125mA – 6.3A	.15 sec., Min; 3 sec. Max
1000%	40mA – 100mA	.01 sec., Min; 0.3 sec. Max
	125mA – 6.3A	.02 sec., Min; 0.3 sec. Max

219XA Series

Electrical Characteristic Specifications by Item

Amp Code	Amp Rating (A)	Voltage Rating (V)	Interrupting Rating	Nominal Cold Resistance (Ohms)	Nominal Melting I ² t (A ² sec)	Nominal Voltage Drop at Rated Current (mV)	Nominal Power Dissipation at Rated Current (W)	Agency Approvals							
															
.040	0.040	250	150A @ 250VAC	31.8620	0.01100	4000	1.6		x		x			x	
.050	0.050	250		21.2920	0.01700	3500	1.6		x		x			x	
.063	0.063	250		14.2685	0.02850	3000	1.6		x		x			x	
.100	0.100	250		6.0180	0.07900	2500	1.6		x		x			x	
.125	0.125	250		4.2000	0.13000	2000	1.6		x	x	x	x	x	x	x
.160	0.160	250		2.5500	0.31000	1900	1.6		x	x	x	x	x	x	x
.200	0.200	250		1.6000	0.32000	1500	1.6		x	x	x	x	x	x	x
.250	0.250	250		1.0495	0.54000	1300	1.6		x	x	x	x	x	x	x
.315	0.315	250		0.8475	1.23000	1100	1.6		x	x	x	x	x	x	x
.400	0.400	250		0.5350	1.40000	1000	1.6		x	x	x	x	x	x	x
.500	0.500	250		0.3700	3.00000	900	1.6		x	x	x	x	x	x	x
.630	0.630	250		0.2750	4.82000	300	1.6		x	x	x	x	x	x	x
.800	0.800	250		0.1635	9.35000	250	1.6		x	x	x	x	x	x	x
001.	1.00	250		0.1165	19.20000	150	1.6	x	x	x	x	x	x	x	x
1.25	1.25	250		0.0817	27.15000	150	1.6	x	x	x	x	x	x	x	x
01.6	1.60	250		0.0551	44.20000	150	1.6	x	x	x	x	x	x	x	x
002.	2.00	250		0.0452	92.70500	150	1.6	x	x	x	x	x	x	x	x
02.5	2.50	250		0.0305	138.00000	120	1.6	x	x	x	x	x	x	x	x
3.15	3.15	250		0.0231	202.00000	100	1.6	x	x	x	x	x	x	x	x
004.	4.00	250		0.0158	330.00000	100	1.6	x	x	x	x	x	x	x	x
005.	5.00	250	0.0117	544.00000	100	1.6	x	x	x	x	x	x	x	x	
06.3	6.3	250	0.0117	1093.03500	100	1.6	x	x	x	x	x	x	x	x	

Temperature Derating Curve

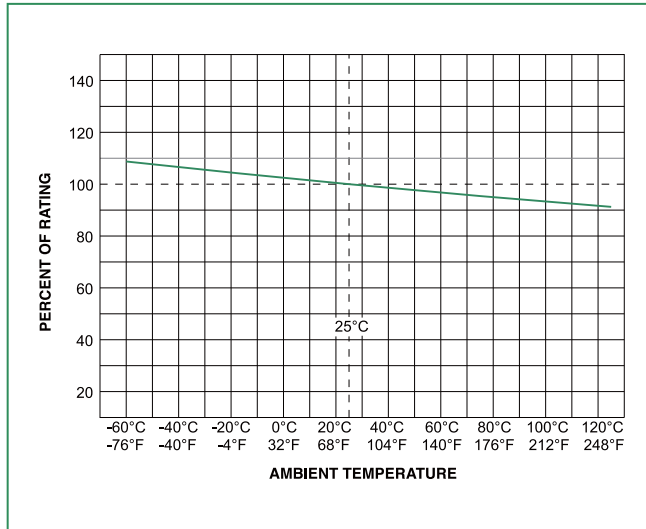

Average Time Current Curves

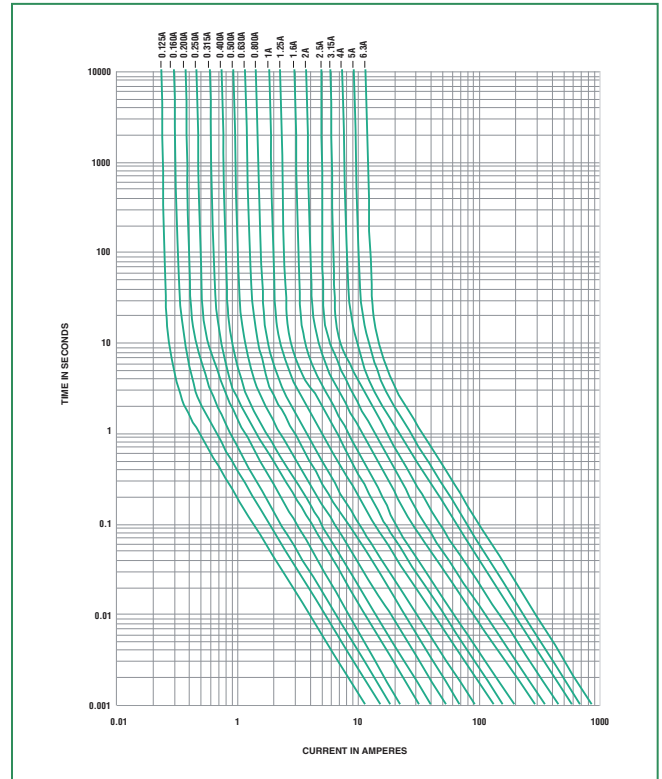

Soldering Parameters - Wave Soldering

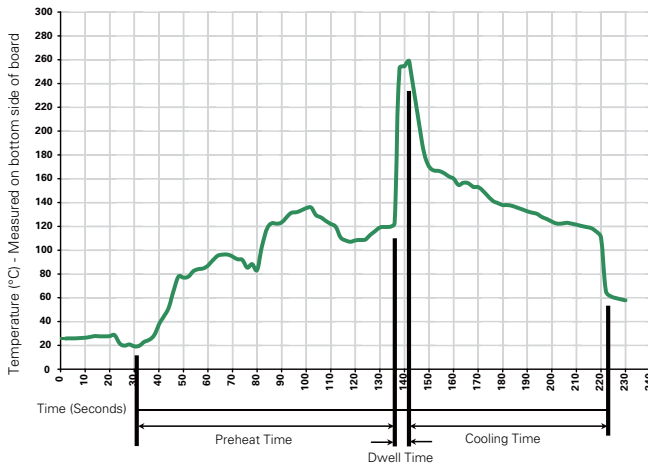

Recommended Process Parameters:

Wave Parameter	Lead-Free Recommendation
Preheat: (Depends on Flux Activation Temperature) (Typical Industry Recommendation)	
Temperature Minimum:	100° C
Temperature Maximum:	150° C
Preheat Time:	60-180 seconds
Solder Pot Temperature:	260° C Maximum
Solder Dwell Time:	2-5 seconds

Recommended Hand-Solder Parameters:

Solder Iron Temperature: 350° C +/- 5° C
 Heating Time: 5 seconds max.

Note: These devices are not recommended for IR or Convection Reflow process.

Product Characteristics

Materials	Body: Glass Cap: Nickel Plated Brass Leads: Tin Plated Copper
Terminal Strength	MIL-STD-202G, Method 211A. Test Condition A
Solderability	Reference IEC 60127 Second Edition 2003-01 Annex A
Product Marking	Cap 1: Brand logo, current and voltage rating Cap 2: Agency approval markings Series
Packaging	Available in Bulk (M=1000 pcs/pkg) or on Tape/Reel (MRET1=1000 pcs/reel)

Operating Temperature	-55°C to +125°C
Shock	MIL-STD-202G, Method 107G, Test Condition B: (5 cycles -65°C to +125°C)
Vibration	MIL-STD-202G, Method 201A
Humidity	MIL-STD-202G, Method 103B, Test Condition A high RH (95%) and elevated temperature (40°C) for 240 hours.
Salt Spray	MIL-STD-202F Method 101D, Test Condition B

Dimensions

0219 000XAP

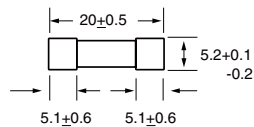

0219000XAEP

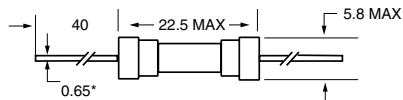

All dimensions in mm

Notes:
* Ratings above 6.3A have 0.8 mm dia lead

Part Numbering System

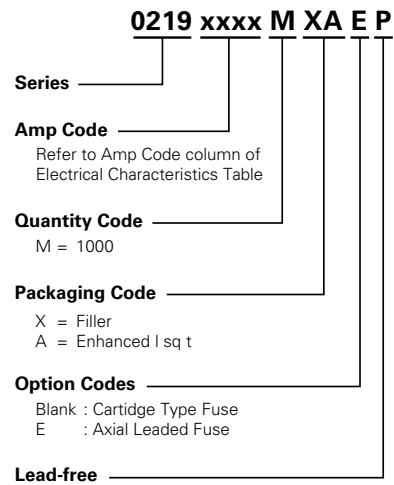

Packaging

Packaging Option	Packaging Specification	Quantity	Quantity & Packaging Code	Taping Width
219XA Series				
Bulk	N/A	1000	MXA	N/A
Bulk	N/A	1000	MXAE	N/A
Reel and Tape	N/A	1000	MRAET1	T1=52mm (2.062")

RoHS  **216 Series, 5 x 20 mm, Fast-Acting Fuse**



Description

5x20mm fast-acting ceramic body cartridge fuse designed to IEC specification.

Features

- Designed to International (IEC) Standards for use globally
- Meets the IEC 60127-2, sheet 1 specification
- for fast-acting fuses
- Available in cartridge and axial lead form
- RoHS compliant and lead-free











Applications

Used as supplementary protection in appliance or utilization equipment to provide individual protection for components or internal circuits.

Electrical Characteristics for Series

% of Ampere Rating	Ampere Rating	Opening Time
150%	50mA – 4A	60 minutes, Minimum
	5A – 6.3A	60 minutes, Minimum
	8A – 16A	30 minutes, Minimum
210%	50mA – 4A	30 minutes, Maximum
	5A – 6.3A	30 minutes, Maximum
	8A – 16A	30 minutes, Maximum
275%	50mA – 4A	0.01 sec., Min.; 2 sec. Max.
	5A – 6.3A	0.01 sec., Min.; 3 sec. Max.
	8A – 16A	0.04 sec., Min.; 20 sec. Max.
400%	50mA – 4A	.003 sec., Min.; 0.3 sec. Max.
	5A – 6.3A	.003 sec., Min.; 0.3 sec. Max.
	8A – 16A	.01 sec., Min.; 1.0 sec. Max.
1000%	50mA – 4A	.02 seconds, Maximum
	5A – 6.3A	.02 seconds, Maximum
	8A – 16A	.03 sec.onds, Maximum

Agency Approvals

Agency	Agency File Number	Ampere Range
	Cartridge Certificates: NBK2508\702-E10480 A&C NBK250702-E10480 E Leaded Certificates: NBK250702-E10480 B & D NBK250702-E10480 F	1A – 10A
	Certificates: 2003010207079960 2002010207007594	50mA – 800mA 1A - 6.3A
	Certificates: SU05001-2013	1A - 10A
	Recognised File: E10480 Guide: JDYX2	50mA – 10A 12.5A, 16A
	File: 029862 Acc. Class: LR1422-30	
	License: KM41462	1A – 6.3A
	File: 9851193, 0149272 0147099 and 811745 508639, 601025	50mA – 6.3A 8A&10A, 16A
	License: 40013834	50mA – 6.3A *8A, *10A
	License: 40016442	*12.5A
		50mA – 16A

*Approval for Cartridge versions only

216 Series

Electrical Characteristics Specifications by Item

Amp Code	Amp Rating (A)	Voltage Rating (V)	Interrupting Rating	Nominal Cold Resistance (Ohms)	Nominal Melting I ² t (A ² sec)	Nominal Voltage Drop at Rated Current (mV)	Nominal Power Dissipation at Rated Current (W)	Agency Approvals									
								UL	CCC	RU	SP	S	CE	UL	VDE	VDE	PS E
.050	0.05	250	1500A@250Vac	15.9000	0.00019	10000	1.6		x	x	x	x	x		x		
.063	0.63	250		10.4500	0.00054	8800	1.6		x	x	x	x	x		x		
.080	0.8	250		7.8850	0.00084	7600	1.6		x	x	x	x	x		x		
.100	0.1	250		5.7925	0.00450	7000	1.6		x	x	x	x	x		x		
.125	0.125	250		3.6750	0.00546	5000	1.6		x	x	x	x	x		x		
.160	0.16	250		5.3490	0.00576	4300	1.6		x	x	x	x	x		x		
.200	0.2	250		3.3500	0.00439	3500	1.6		x	x	x	x	x		x		
.250	0.25	250		2.3500	0.00891	2800	2.5		x	x	x	x	x		x		
.315	0.315	250		1.8500	0.01000	2500	2.5		x	x	x	x	x		x		
.400	0.4	250		0.9065	0.04000	2000	2.5		x	x	x	x	x		x		
.500	0.5	250		0.8660	0.16500	1800	2.5		x	x	x	x	x		x		
.630	0.63	250		0.4650	0.17500	1500	2.5		x	x	x	x	x		x		
.800	0.8	250		0.2950	0.28500	1200	2.5		x	x	x	x	x		x		
001.	1	250		0.2370	0.18000	1000	2.5	x	x	x	x	x	x	x	x		x
1.25	1.25	250		0.1530	0.48000	800	4	x	x	x	x	x	x	x	x		x
01.6	1.6	250		0.1112	1.00500	600	4	x	x	x	x	x	x	x	x		x
002.	2	250		0.0764	1.87000	500	4	x	x	x	x	x	x	x	x		x
02.5	2.5	250		0.0584	2.69500	400	4	x	x	x	x	x	x	x	x		x
3.15	3.15	250		0.0368	6.70000	350	4	x	x	x	x	x	x	x	x		x
004.	4	250		0.0247	14.99500	300	4	x	x	x	x	x	x	x	x		x
005.	5	250		0.0183	27.46000	250	4	x	x	x	x	x	x	x	x		x
06.3	6.3	250		0.0137	56.43000	200	4	x	x	x	x	x	x	x	x		x
008.	8	250		0.0123	64.31500	200	4	x		x	x	x	x		x*		x
010.	10	250		0.0079	154.34000	200	4	x		x	x	x	x		x*		x
12.5	12.5	250	0.0057	235.00000	200	4			x	x		x			x*		
016.	16	250	750A@250Vac	0.0040	462.50000	200	4.5			x	x	x	x				

* Approval for cartridge versions only.

Temperature Derating Curve

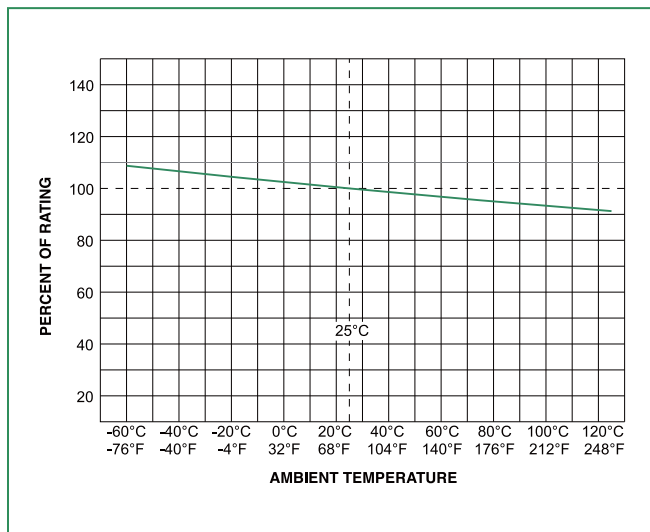

Average Time Current Curves

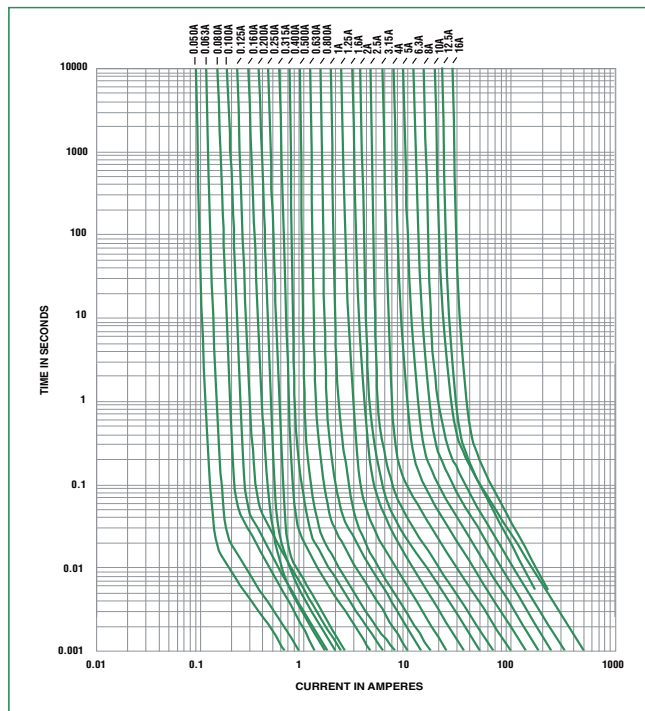

Soldering Parameters - Wave Soldering



Recommended Process Parameters:

Wave Parameter	Lead-Free Recommendation
Preheat:	
(Depends on Flux Activation Temperature)	(Typical Industry Recommendation)
Temperature Minimum:	100° C
Temperature Maximum:	150° C
Preheat Time:	60-180 seconds
Solder Pot Temperature:	260° C Maximum
Solder Dwell Time:	2-5 seconds

Recommended Hand-Solder Parameters:

Solder Iron Temperature: 350° C +/- 5° C
 Heating Time: 5 seconds max.

Note: These devices are not recommended for IR or Convection Reflow process.

Product Characteristics

Material	Body: Ceramic Cap: Nickel-plated brass Leads: Tin-plated Copper Filler (160mA-16A): Sand
Terminal Strength	MIL-STD-202G, Method 211A, Test Condition A
Solderability	Reference IEC 60127 Second Edition 2003-01 Annex A
Product Marking	Cap 1: Brand logo, current and voltage rating Cap 2: Agency approval markings
Packaging	Available in Bulk (M=1000 pcs/pkg) or on Tape/Reel (MRET1=1000 pcs/reel)

Operating Temperature	-55°C to +125°C
Thermal Shock	MIL-STD-202G, Method 107G, Test Condition B: (5 cycles -65°C to +125°C)
Vibration	MIL-STD-202G, Method 201A
Humidity	MIL-STD-202G, Method 103B, Test Condition A. high RH (95%) and elevated temperature (40°C) for 240 hours.
Salt Spray	MIL-STD-202G, Method 101D, Test Condition B

Dimensions

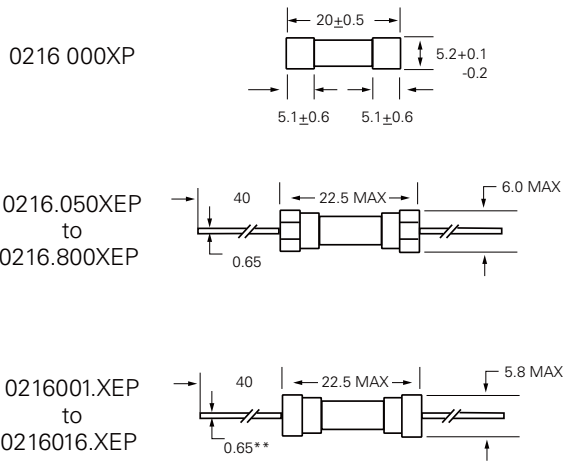

All dimensions in mm
 ** Ratings above 6.3A have 0.8 mm diameter lead

Part Numbering System

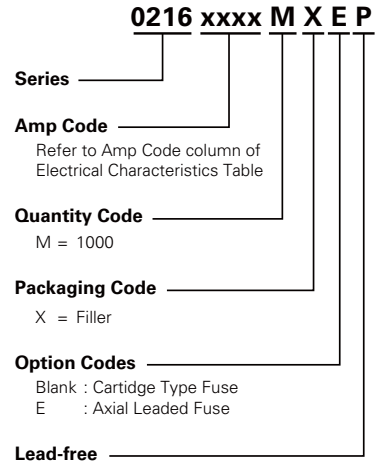

Packaging

Packaging Option	Packaging Specification	Quantity	Quantity & Packaging Code	Taping Width
216 Series				
Bulk	N/A	1000	MX	N/A
Bulk	N/A	1000	MXE	N/A
Reel and Tape	EIA 296-E	1000	MRET1	T1=52mm (2.062")

RoHS  **215 Series, 5 x 20 mm, Time-Lag (Slo-Blo®) Fuse**



Description

5x20mm Time-Lag surge withstand ceramic body cartridge fuse designed to IEC specification











Features

- Designed to International (IEC) Standards for use globally
- High breaking capacity
- Meet the IEC 60127-2, Sheet 5 specification for Time-Lag fuses
- RoHS compliant and lead-free

Applications

Used as supplementary protection in appliance or utilization equipment to provide individual protection for components or internal circuits.

Agency Approvals

Agency	Agency File Number	Ampere Range
	Cartridge Certificates: NBK080205-E10480A NBK250702-E10480E NBK100408-JP1021A Leaded Certificates: NBK080205-E10480B NBK250702-E10480F NBK100408-JP1021B	1A – 5A 6.3A – 15A 16A – 20A 1A – 5A 6.3A – 15A 16A – 20A
	Certificates: 2005010207145714	1A – 6.3A
	Certificates: SU05001– 2011 SU05001– 2012	1A – 3.15A 4A – 10A
	Recognised File: E10480	125mA – 160mA 500mA – 20A
	File: 029862 Acc. Class: LR1422 – 30	500mA – 12A
	License: KM41462	200mA – 10A
	License: 606726 902193 915511 0147100 709071 709302	125mA, 160mA 200mA – 800mA, 8A, 10A 1A – 3.15A 4A – 6.3A 12A *15A – *20A
	License: 40013521	200mA – 8A *10A
	License: 40016610	*12A
		125mA – 20A

* Approved for cartridge versions only

Electrical Characteristics for Series

% of Ampere Rating	Ampere Rating	Opening Time
150%	125mA – 800mA	60 minutes, Minimum
	1A – 3.15A	60 minutes, Minimum
	4A – 6.3A	60 minutes, Minimum
	8A – 20A	30 minutes, Minimum
210%	125mA – 800mA	30 minutes, Maximum
	1A – 3.15A	30 minutes, Maximum
	4A – 6.3A	30 minutes, Maximum
275%	125mA – 800mA	.25 sec. Min.; 80 secs. Max.
	1A – 3.15A	.75 sec. Min.; 80 secs. Max.
	4A – 6.3A	.75 sec. Min.; 80 secs. Max.
400%	125mA – 800mA	.05 sec., Min.; 5 secs. Max.
	1A – 3.15A	.095 sec., Min.; 5 secs. Max.
	4A – 6.3A	.150 sec., Min.; 5 secs. Max.
1000%	125mA – 800mA	.005 sec., Min.; .150 sec. Max.
	1A – 3.15A	.010 sec., Min.; .150 sec. Max.
	4A – 6.3A	.010 sec., Min.; .150 sec. Max.
	8A – 20A	.010 sec., Min.; .150 sec. Max.

215 Series

Electrical Characteristic Specifications by Item

Amp Code	Amp Rating	Voltage Rating (V)	Interrupting Rating	Nominal Cold Resistance (Ohms)	Nominal Melting I ² t (A ² sec)	Maximum Voltage Drop at Rated Current (mV)	Maximum Power Dissipation at Rated Current (W)	Agency Approvals												
								PS E	CCC	UL	UL	UL	UL	UL	UL	DVE	VDE	CE		
.125	0.125	250	1500 A @ 250 VAC	11.4455	0.0330	2600	1.6					x			x				x	
.160	0.16	250		7.1000	0.0465	2400	1.6					x				x				x
.200	0.2	250		1.8400	0.340	2100	1.6								x	x	x			x
.250	0.25	250		1.2400	0.545	1500	1.6							x	x	x				x
.315	0.315	250		0.8800	0.975	1100	1.6							x	x	x				x
.400	0.4	250		0.5825	1.325	1000	1.6							x	x	x				x
.500	0.5	250		1.1675	0.420	850	1.6						x	x	x	x	x			x
.630	0.63	250		0.7200	0.635	650	1.6						x	x	x	x	x			x
.800	0.8	250		0.4675	0.975	500	1.6						x	x	x	x	x			x
001.	1	250		0.1515	1.520	350	2.5	x	x	x	x	x	x	x	x	x	x			x
1.25	1.25	250		0.1074	3.200	300	2.5	x	x	x	x	x	x	x	x	x	x			x
01.6	1.6	250		0.0707	6.830	200	2.5	x	x	x	x	x	x	x	x	x	x			x
002.	2	250		0.0566	11.680	190	2.5	x	x	x	x	x	x	x	x	x	x			x
02.5	2.5	250		0.0386	22.290	180	2.5	x	x	x	x	x	x	x	x	x	x			x
3.15	3.15	250		0.0283	43.255	140	4	x	x	x	x	x	x	x	x	x	x			x
004.	4	250		0.0185	46.960	100	4	x	x	x	x	x	x	x	x	x	x			x
005.	5	250		0.0153	66.095	100	4	x	x	x	x	x	x	x	x	x	x			x
06.3	6.3	250		0.0108	128.750	100	4	x	x	x	x	x	x	x	x	x	x			x
008.	8	250		0.0092	209.880	100	4	x		x	x	x	x	x	x	x	x			x
010.	10	250		0.0066	333.565	100	4	x		x	x	x	x	x	x	x	x*			x
012.	12	250	0.0061	515.500	100	4	x			x	x		x			x*			x	
015.	15	250	500 A	0.0033	1237.0	TBA**	TBA**	x			x				x*					
016.	16	250		0.0031	1408.0	TBA**	TBA**	TBA**	x			x				x*				
020.	20	250	400 A	0.0023	3986.5	TBA**	TBA**	x			x				x*					

X* Approval for cartridge versions only

TBA** - Please contact Littelfuse for details on these parameters

1A to 2A have an IR : 100A@500VAC, 4A to 6-3A have the IR : 100A@305 VAC and 1000A@72VDC

Temperature Derating Curve

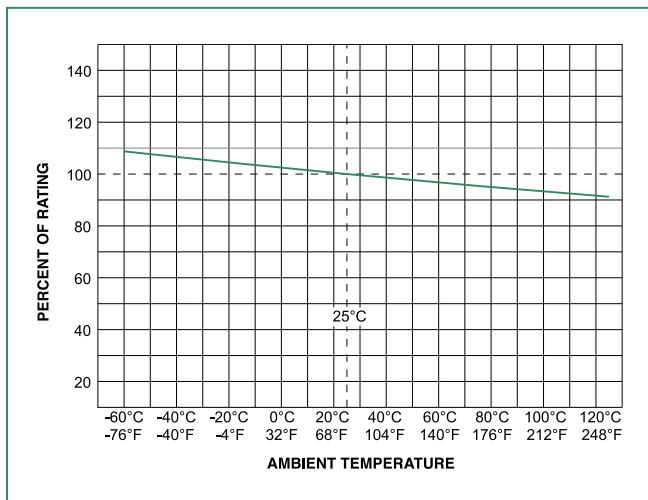

Average Time Current Curves

T-C Curves for 125mA to 800mA only

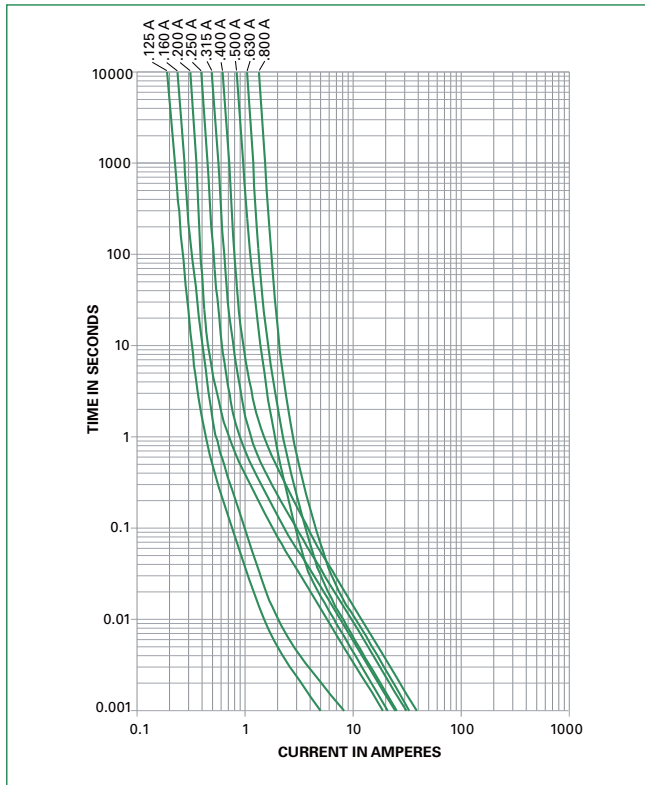

T-C Curves for 1A to 20A only

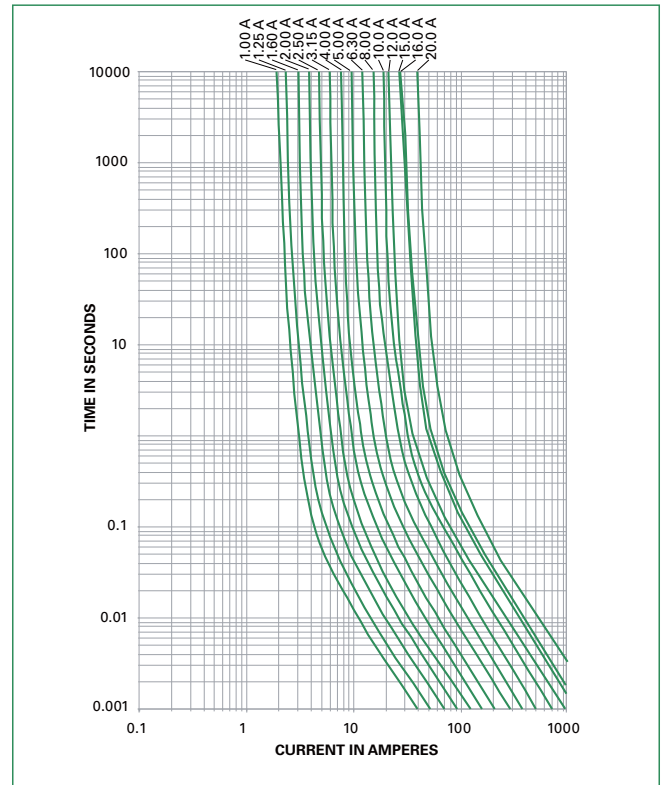

Soldering Parameters - Wave Soldering

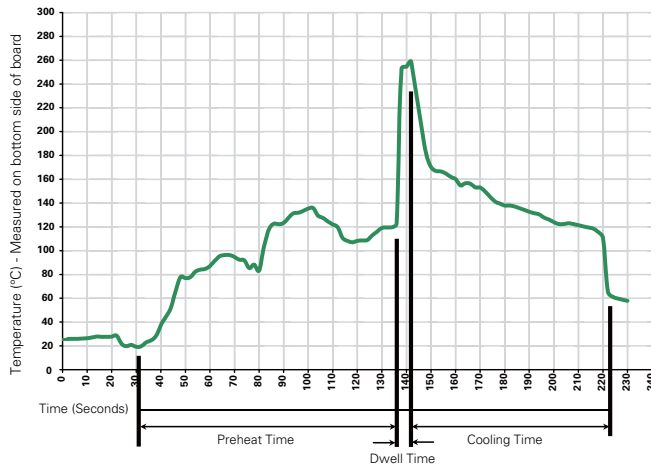

Recommended Process Parameters:

Wave Parameter	Lead-Free Recommendation
Preheat: (Depends on Flux Activation Temperature) (Typical Industry Recommendation)	
Temperature Minimum:	100° C
Temperature Maximum:	150° C
Preheat Time:	60-180 seconds
Solder Pot Temperature:	260° C Maximum
Solder Dwell Time:	2-5 seconds

Recommended Hand-Solder Parameters:

Solder Iron Temperature: 350° C +/- 5° C
 Heating Time: 5 seconds max.

Note: These devices are not recommended for IR or Convection Reflow process.

Product Characteristics

Materials	Body: Ceramic Cap: Nickel-plated Brass Leads: Tin-plated Copper
Terminal Strength	MIL-STD-202G, Method 211A, Test Condition A
Solderability	Reference IEC 60127 Second Edition 2003-01 Annex A
Product Marking	Cap 1: Brand logo, current and voltage ratings Cap 2: Agency approval markings

Operating Temperature	-55°C to +125°C
Thermal Shock	MIL-STD-202G, Method 107G, Test Condition B (5 cycles, -65°C to +125°C)
Vibration	MIL-STD-202G, Method 201A
Humidity	MIL-STD-202G, Method 103B, Test Condition A (High RH (95%) and elevated temp (40°C) for 240 hours)
Salt Spray	MIL-STD-202G, Method 101D, Test Condition B

Dimensions

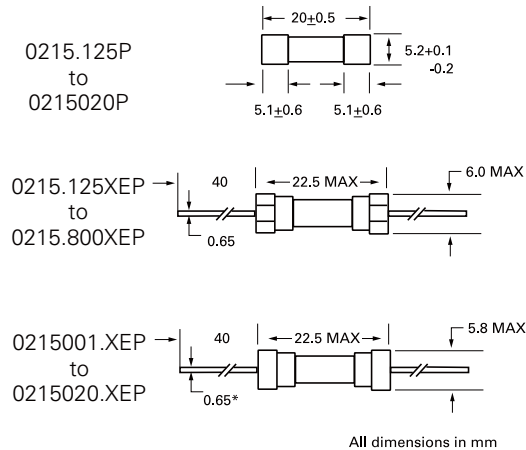

* Ratings above 6.3 A have 0.8 mm diameter lead;
ratings above 12 A have 1.2 mm diameter lead

Part Numbering System

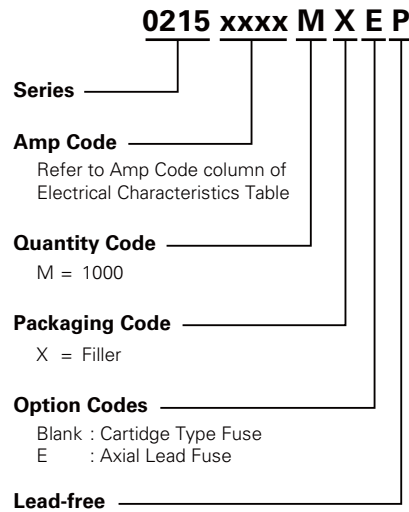

Packaging

Packaging Option	Packaging Specification	Quantity	Quantity & Packaging Code	Taping Width
215 Series				
Bulk	N/A	1000	MX	N/A
Bulk	N/A	1000	MXE	N/A
Reel and Tape	N/A	1000	MRET1	T1=52mm (2.062")

RoHS **Pb** **232 Series, 5 x 20 mm, Medium-Acting Fuse**

Description

5x20mm medium-acting glass body cartridge fuse designed to Meti B Standard.

Features

- Designed to Japanese Standard JIS C6575
- Available in cartridge and axial lead format
- RoHS compliant and lead-free

Applications

Used as supplementary protection in appliance or utilization equipment to provide individual protection for components or internal circuits.

Agency Approvals

Agency	Agency File Number	Ampere Range
	Cartridge Certificates: NBK260202-E10480 B NBK290502-E10480 D	1A – 5A 6.3A – 10A
	Leaded Certificates: NBK290502-E10480 B NBK290502-E10480 F	1A – 5A 6.3A – 10A
	Certificates: SU05001-2015	1A – 10A
		1A – 10A

Electrical Characteristics for Series

% of Ampere Rating	Opening Time
130%	1 hour, Minimum
160%	1 hour, Maximum
200%	2 minutes, Maximum

Electrical Characteristic Specifications by Item

Amp Code	Amp Rating (A)	Voltage Rating (V)	Interrupting Rating	Nominal Cold Resistance (Ohms)	Nominal Melting I ² t (A ² sec)	Agency Approvals		
001.	1	125/250	10,000A @ 125VAC	0.0923	1.37300	x	x	x
1.25	1.25	125/250		0.0685	4.11000	x	x	x
01.6	1.6	125/250		0.0537	6.96000	x	x	x
002.	2	125/250		0.0370	8.25000	x	x	x
02.5	2.5	125/250		0.0291	13.87500	x	x	x
003.	3	125/250		0.0226	17.19000	x	x	x
3.15	3.15	125/250		0.0215	21.9500	x	x	x
004.	4	125/250		0.0174	37.73000	x	x	x
005.	5	125/250		0.0134	56.72000	x	x	x
06.3	6.3	125/250		0.0102	90.41500	x	x	x
008.*	8	125/250	300A @ 125VAC	0.0076	182.58000	x	x	x
010.*	10	125/250		0.0059	290.66500	x	x	x

To order 125Vac rated, please add part no. suffix

* Interrupting Rating for 8A & 10A is 100A@250Vac

Temperature Derating Curve

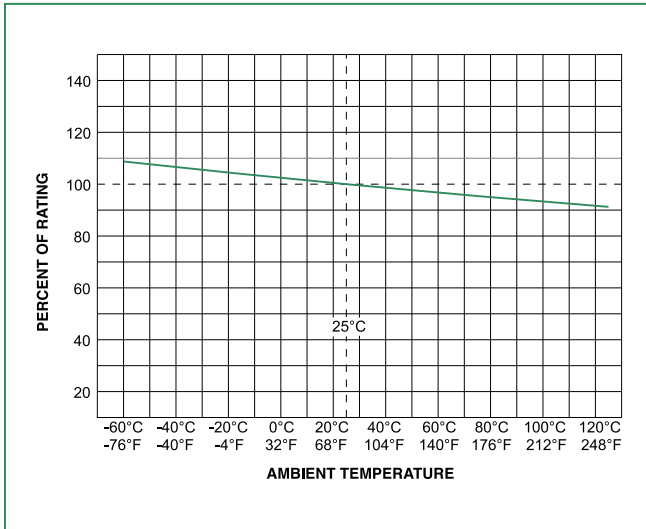

Average Time Current Curves

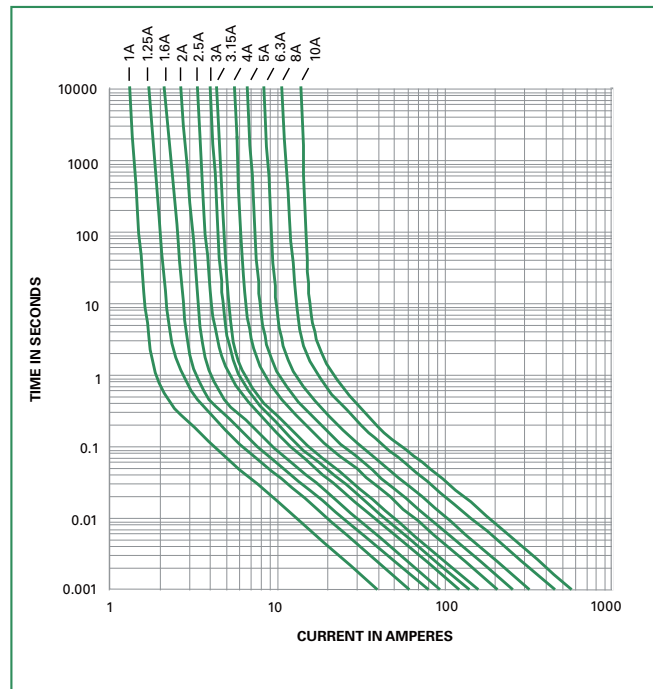

Soldering Parameters - Wave Soldering

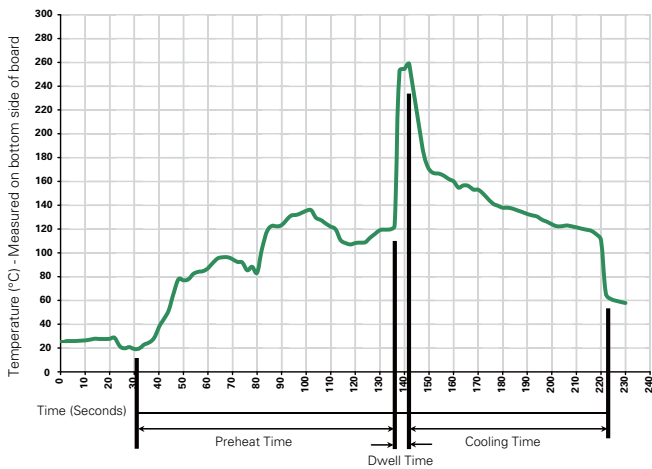

Recommended Process Parameters:

Wave Parameter	Lead-Free Recommendation
Preheat: (Depends on Flux Activation Temperature) (Typical Industry Recommendation)	
Temperature Minimum:	100° C
Temperature Maximum:	150° C
Preheat Time:	60-180 seconds
Solder Pot Temperature:	260° C Maximum
Solder Dwell Time:	2-5 seconds

Recommended Hand-Solder Parameters:

Solder Iron Temperature: 350° C +/- 5°C
Heating Time: 5 seconds max.

Note: These devices are not recommended for IR or Convection Reflow process.

Product Characteristics

Materials	Body: Glass Cap: Nickel-plated brass Leads: Tin-plated Copper
Terminal Strength	MIL-STD-202G, Method 211A. Test Condition A
Solderability	Reference IEC 60127 Second Edition 2003-01 Annex A
Product Marking	Cap 1: Brand log, current and voltage ratings, and agency approval Cap 2: Blank
Packaging	Available in Bulk (M=1000 pcs/pkg) or on Tape/Reel (MRET1=1000 pcs/reel)

Operating Temperature	-55°C to +125°C
Thermal Shock	MIL-STD-202G, Method 107G, Test Condition B: (5 cycles -65°C + 125°C)
Vibration	MIL-STD-202G, Method 201A
Humidity	MIL-STD-202G, Method 103B, Test Condition A high RH (95%) and elevated temperature (40°C) for 240 hours.
Salt Spray	MIL-STD-202G, Method 101D, Test Condition B

Dimensions

0232 000P

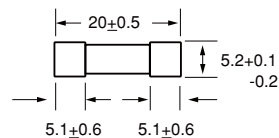

0232 000 XEP

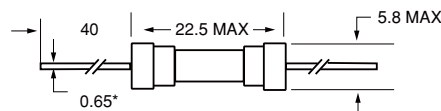

All dimensions in mm

Notes:

* Ratings above 6.3A have 0.8 mm dia lead

Part Numbering System

0232 xxxx M X 125 P

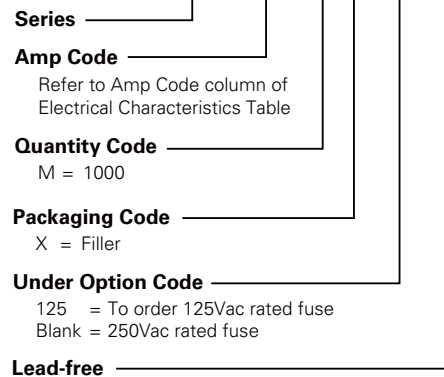

Packaging

Packaging Option	Packaging Specification	Quantity	Quantity & Packaging Code	Taping Width
232 Series				
Bulk	N/A	1000	MX	N/A
Bulk	N/A	1000	MXE	N/A
Reel and Tape	EIA 296-E	1000	MRET1	T1=52mm (2.062")

RoHS  **235 Series, 5 x 20 mm, Fast-Acting Fuse**



Description

5x20mm fast-acting glass body cartridge fuse designed to UL specification.





Features

- Designed to UL/CSA/ ANCE 248 Standard
- Available in cartridge and axial lead format
- RoHS compliant and lead-free

Applications

Used as supplementary protection in appliance or utilization equipment to provide individual protection for components or internal circuits.

Agency Approvals

Agency	Agency File Number	Ampere Range
	Cartridge Certificates: NBK290502-E10480 G NBK290502-E10480 I Leaded Certificates: NBK290502-E10480 H NBK290502-E10480 J	1A – 5A 6A & 7A
	Certificates: SU05001 – 3007 SU05001 – 2002 SU05001 – 2003	100mA – 400mA 500mA – 3A 4A – 6A
	Listed File: E10480 Guide No: JDYX	100mA - 7A
	File No: 029862 Certificate Class No: LR1422-01	100mA – 3A 4A – 6A
		100mA – 7A

Electrical Characteristics for Series

% of Ampere Rating	Ampere Rating	Opening Time
100%	100mA – 7A	4 hours, Minimum
135%		1 hour, Maximum
200%		5 seconds, Maximum

Electrical Characteristic Specifications by Item

Amp Code	Amp Rating (A)	Voltage Rating (V)	Interrupting Rating	Nominal Cold Resistance (Ohms)	Nominal Melting I ² t (A ² sec)	Agency Approvals				
						CE	UL	SF	PS E	RoHS
.100	0.1	250	35A@250Vac, 10000A@125Vac	8.4000	0.00312	x	x	x		x
.125	0.125	250		5.7500	0.00273	x	x	x		x
.200	0.2	250		3.1500	0.00867	x	x	x		x
.250	0.25	250		2.2500	0.01660	x	x	x		x
.300	0.3	250		1.6000	0.03215	x	x	x		x
.400	0.4	250		1.750	0.05845	x	x	x		x
.500	0.5	250		0.4265	0.06915	x	x	x		x
.600	0.6	250		0.3195	0.11200	x	x	x		x
.700	0.7	250		0.2625	0.15600	x	x	x		x
.800	0.8	250		0.1920	0.25300	x	x	x		x
001.	1	250	100A@250Vac, 10000A@125Vac	0.1530	0.46750	x	x	x	x	x
1.25	1.25	250		0.1055	1.08500	x	x	x	x	x
01.6	1.6	250		0.0758	2.02500	x	x	x	x	x
002.	2	250		0.0603	2.64500	x	x	x	x	x
02.5	2.5	250		0.0437	5.44500	x	x	x	x	x
003.	3	250		0.0347	8.39500	x	x	x	x	x
03.5	3.5	250	0.0331	17.14000	x	x		x		
004.	4	125	10000@125Vac	0.0246	17.14000	x	x	x	x	x
005.	5	125		0.0184	27.41000	x	x	x	x	x
006.	6	125		0.0148	47.32500	x	x	x	x	x
007.	7	125		0.0157	64.81500	x	x		x	

Temperature Derating Curve

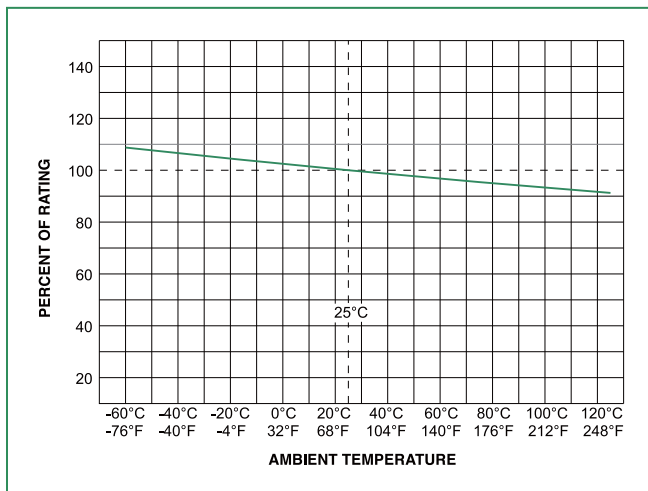

Average Time Current Curves

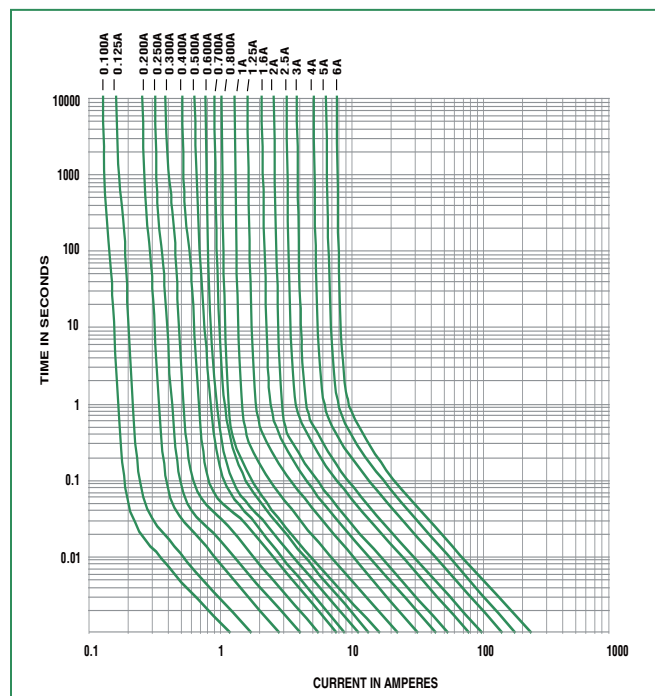

Please contact Littelfuse for details on FC curve for 7A rating

Soldering Parameters - Wave Soldering

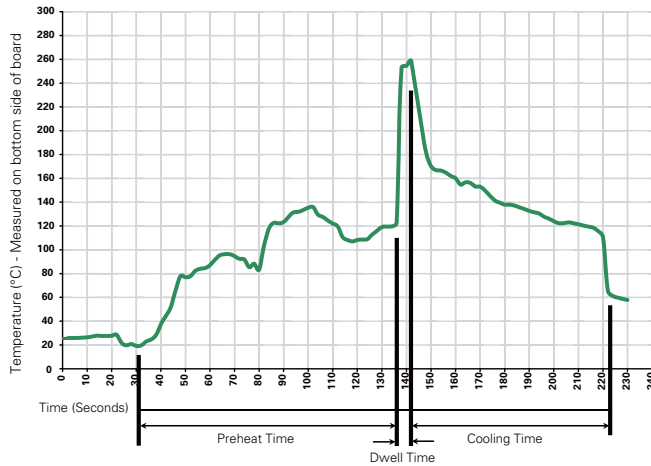

Recommended Process Parameters:

Wave Parameter	Lead-Free Recommendation
Preheat: (Depends on Flux Activation Temperature) (Typical Industry Recommendation)	
Temperature Minimum:	100° C
Temperature Maximum:	150° C
Preheat Time:	60-180 seconds
Solder Pot Temperature:	260° C Maximum
Solder Dwell Time:	2-5 seconds

Recommended Hand-Solder Parameters:

Solder Iron Temperature: 350° C +/- 5°C
 Heating Time: 5 seconds max.

Note: These devices are not recommended for IR or Convection Reflow process.

Product Characteristics

Materials	Body: Glass Cap: Nickel-plated brass Leads: Tin-plated Copper
Terminal Strength	MIL-STD-202G, Method 211A. Test Condition A
Solderability	Reference IEC 60127 Second Edition 2003-01 Annex A
Product Marking	Cap 1: Brand logo, current and voltage rating Cap 2: Series and agency approval markings
Packaging	Available in Bulk (M=1000 pcs/pkg) or on Tape/Reel (MRET1=1000 pcs/reel)

Operating Temperature	-55°C to +125°C
Thermal Shock	MIL-STD-202G, Method 107G, Test Condition B: (5 cycles -65°C + 125°C)
Vibration	MIL-STD-202G, Method 201A
Humidity	MIL-STD-202G, Method 103B, Test Condition A high RH (95%) and elevated temperature (40° C) for 240 hours
Salt Spray	MIL-STD-202G, Method 101D, Test Condition B

Dimensions

0235000P

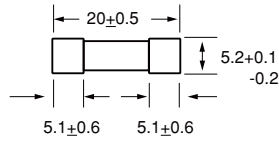

**0235.100 XEP
to
0235.400 XEP**

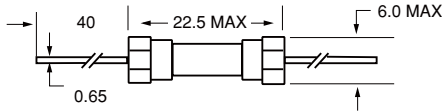

**0235.500 XEP
to
0235006.XEP**

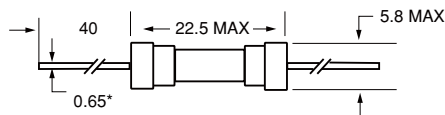

All dimensions in mm

Notes:

* Ratings above 6.3A
ø0.8 mm dia lead

Part Numbering System

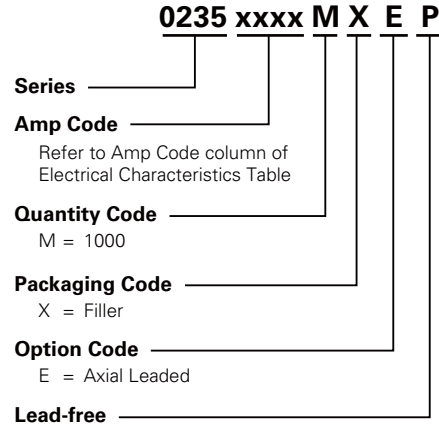

Packaging

Packaging Option	Packaging Specification	Quantity	Quantity & Packaging Code	Taping Width
235 Series				
Bulk	N/A	1000	MX	N/A
Bulk	N/A	1000	MXB	N/A
Reel and Tape	EIA 296-E	1000	MRET1	T1=52mm (2.062")

RoHS  **233 Series, 5 x 20 mm, Medium-Acting Fuse**

Description

5x20mm medium-acting glass body fuse designed to UL specification.





Features

- Designed to UL/CSA/ ANCE 248 Standard
- Available in cartridge and axial lead format
- RoHS compliant and lead-free

Applications

Used as supplementary protection in appliance or utilization equipment to provide individual protection for components or internal circuits.





Agency Approvals

Agency	Agency File Number	Ampere Range
	Cartridge Certificates: NBK280602-E10480 C NBK290502-E10480 I	1A – 5A 6A – 10A
	Leaded Certificates: NBK280602-E10480 D NBK290502-E10480 J	1A – 5A 6A – 10A
	Certificates: SU05001 – 2010	1A – 6.5A
	Listed File: E10480 Guide: JDYX	1A – 10A
	File: 029862 Acc. Class: LR1422-01	
		
		

Electrical Characteristics for Series

% of Ampere Rating	Ampere Rating	Opening Time
100%	1A – 3.5A	4 hours, Minimum
	4A – 7A	1 hour, Minimum
	8A – 10A	1 hour, Minimum
135%	1A – 3.5A	15 sec., Min; 1500 sec., Max.
	4A – 7A	15 sec., Min; 1500 sec., Max.
	8A – 10A	3 sec., Min; 3600 sec., Max.
200%	1A – 3.5A	.60 sec., Min; 3 sec., Max.
	4A – 7A	.60 sec., Min; 3 sec., Max.
	8A – 10A	0.4 sec., Min; 2.25 sec., Max.

Electrical Characteristic Specifications by Item

Amp Code	Amp Rating (A)	Voltage Rating (V)	Interrupting Rating	Nominal Cold Resistance (Ohms)	Nominal Melting I ² t (A ² sec)	Agency Approvals				
										
001.	1	125	10,000A @ 125 VAC	0.1750	1.97500	x	x	x	x	x
1.25	1.25	125		0.1263	3.39000	x	x	x	x	x
01.6	1.6	125		0.0880	6.14000	x	x	x	x	x
002.	2	125		0.0684	9.97000	x	x	x	x	x
02.5	2.5	125		0.0521	17.04500	x	x	x	x	x
003.	3	125		0.0431	26.24000	x	x	x	x	x
3.15	3.15	125		0.0380	29.79500	x	x	x	x	x
03.5	3.5	125		0.0322	36.27500	x	x	x	x	x
004.	4	125		0.0293	51.61000	x	x	x	x	x
005.	5	125		0.0217	89.97500	x	x	x	x	x
006.	6	125		0.0179	131.45500	x	x	x	x	x
06.3	6.3	125		0.0166	151.90500	x	x	x	x	x
007.	7	125		0.0137	157.31000	x	x		x	
008.	8	125		0.0084	169.43500	x	x	x	x	
010.	10	125		0.0066	274.11500	x	x	x	x	

Temperature Derating Curve

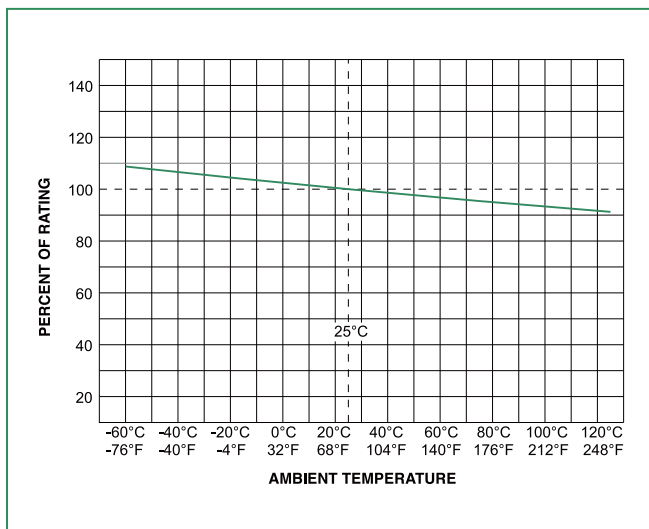

Average Time Current Curves

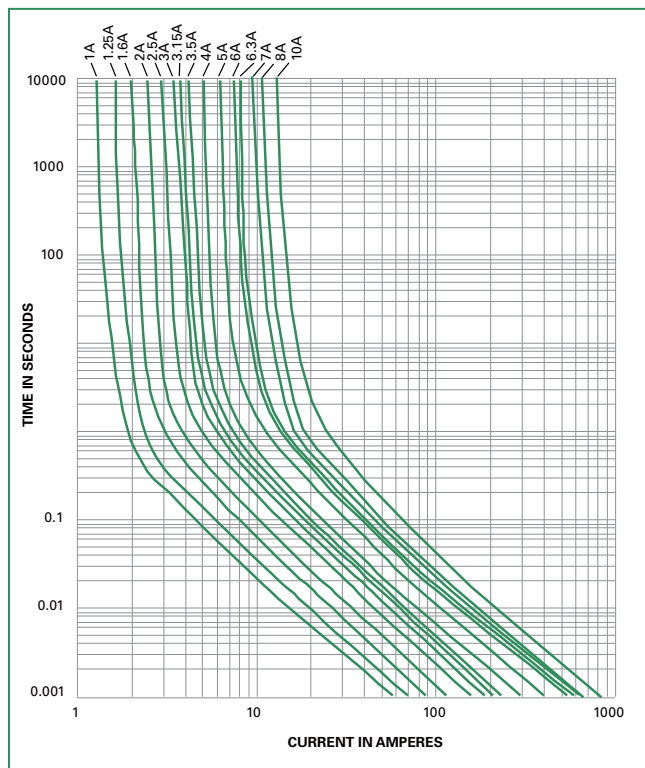

Soldering Parameters - Wave Soldering

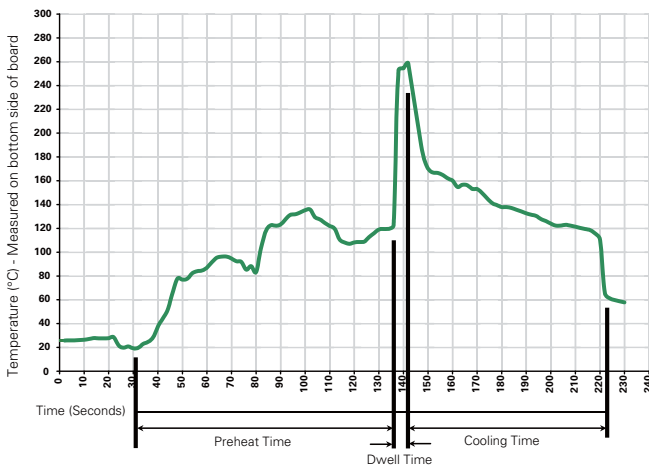

Recommended Process Parameters:

Wave Parameter	Lead-Free Recommendation
Preheat: (Depends on Flux Activation Temperature)	(Typical Industry Recommendation)
Temperature Minimum:	100° C
Temperature Maximum:	150° C
Preheat Time:	60-180 seconds
Solder Pot Temperature:	260° C Maximum
Solder Dwell Time:	2-5 seconds

Recommended Hand-Solder Parameters:

Solder Iron Temperature: 350° C +/- 5° C
Heating Time: 5 seconds max.

Note: These devices are not recommended for IR or Convection Reflow process.

Product Characteristics

Materials	Body: Glass Cap: Nickel-plated brass Leads: Tin-plated Copper
Terminal Strength	MIL-STD-202G, Method 211A, Test Condition A
Solderability	Reference IEC 60127 Second Edition 2003-01 Annex A
Product Marking	Cap 1: Brand logo, current and voltage rating Cap 2: Series and agency approval markings
Packaging	Available in Bulk (M=1000 pcs/pkg) or on Tape/Reel (MRET1=1000 pcs/reel)

Operating Temperature	-55°C to +125°C
Thermal Shock	MIL-STD-202G, Method 107G, Test Condition B: (5 cycles -65°C to +125°C)
Vibration	MIL-STD-202G, Method 201A
Humidity	MIL-STD-202G, Method 103B, Test Condition A. high RH (95%) and elevated temp (40°C) for 240 hours
Salt Spray	MIL-STD-202G, Method 101D, Test Condition B

Dimensions

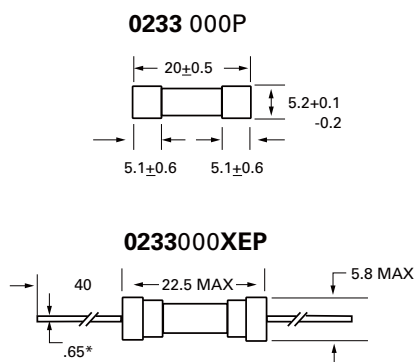

All dimensions in mm

Notes:
* Ratings above 6.3A have 0.8 mm dia lead

Part Numbering System

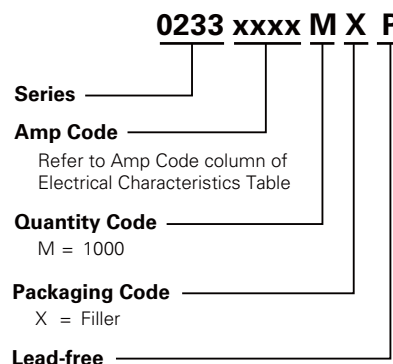

Packaging

Packaging Option	Packaging Specification	Quantity	Quantity & Packaging Code	Taping Width
233 Series				
Bulk	N/A	1000	MX	N/A
Bulk	N/A	1000	MXE	N/A
Reel and Tape	EIA 296-E	1000	MRET1	T1=52mm (2.062")

RoHS  **234 Series, 5 x 20 mm, Medium-Acting Fuse**



Description

5x20mm medium-acting glass/ceramic body cartridge fuse designed to UL specification.





Features

- Designed to UL/CSA/ ANCE 248 Standard
- Available in cartridge and axial lead format
- Glass body for 1-3.5A, Ceramic body for 4-10A
- RoHS compliant and lead-free

Applications

Used as supplementary protection in appliance or utilization equipment to provide individual protection for components or internal circuits.





Agency Approvals

Agency	Agency File Number	Ampere Range
	Cartridge Certificates: NBK290502-E10480 C NBK280602-E10480 E NBK280602-E10480 G	1A – 3.5A 4A & 5A 6A – 10A
	Leaded Certificates: NBK290502-E10480 H NBK280602-E10480 F NBK280602-E10480 H	1A – 3.5A 4A & 5A 6A – 10A
	Certificates: SU05001 – 3001 SU05001 – 4001 SU05001 – 2016	1A – 3.15A 3.5A 4A – 10A
	Listed File: E10480 Guide: JDYX	1A – 10A
	File: 029862 Certificate Class: LR1422-01	
		
		

Electrical Characteristics for Series

% of Ampere Rating	Ampere Rating	Opening Time
100%	1 – 3.5	4 hours, Minimum
	4 – 10	1 hour, Minimum
135%	1 – 3.5	3 sec., Min; 1 hr. Max
	4 – 10	3 sec., Min; 1 hr. Max
200%	1 – 3.5	400ms., Min; 2.25 sec. Max
	4 – 10	400ms., Min; 4 sec. Max

Electrical Characteristic Specification by Item

Amp Code	Ampere Rating (A)	Voltage Rating (V)	Interrupting Rating	Nominal Cold Resistance (Ohms)	Nominal Melting I ² t (A ² sec)	Agency Approvals				
										
001.	1	250	100A @ 250 VAC 10000A @ 125 VAC	0.1750	1.97500	x	x	x	x	x
1.25	1.25	250		0.1262	3.39000	x	x	x	x	x
01.6	1.6	250		0.0884	6.14000	x	x	x	x	x
002.	2	250		0.0684	9.97000	x	x	x	x	x
02.5	2.5	250		0.0521	17.04500	x	x	x	x	x
003.	3	250		0.0431	26.2400	x	x	x	x	x
3.15	3.15	250		0.0380	29.79500	x	x	x	x	x
03.5	3.5	250		0.0322	36.27500	x	x	x	x	x
004.	4	250		0.0304	10.37000	x	x	x	x	x
005.	5	250		0.0214	20.64500	x	x	x	x	x
006.	6	250	0.0194	33.01500	x	x	x	x	x	
06.3	6.3	250	0.0168	37.68500	x	x	x	x	x	
008.	8	250	0.0144	80.67500	x	x	x	x	x	
010.	10	250	0.0107	129.02500	x	x	x	x	x	

Temperature Derating Curve

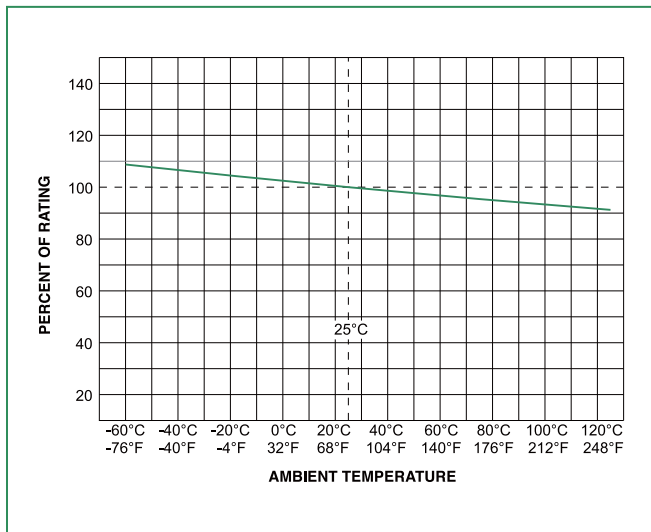

Average Time Current Curves

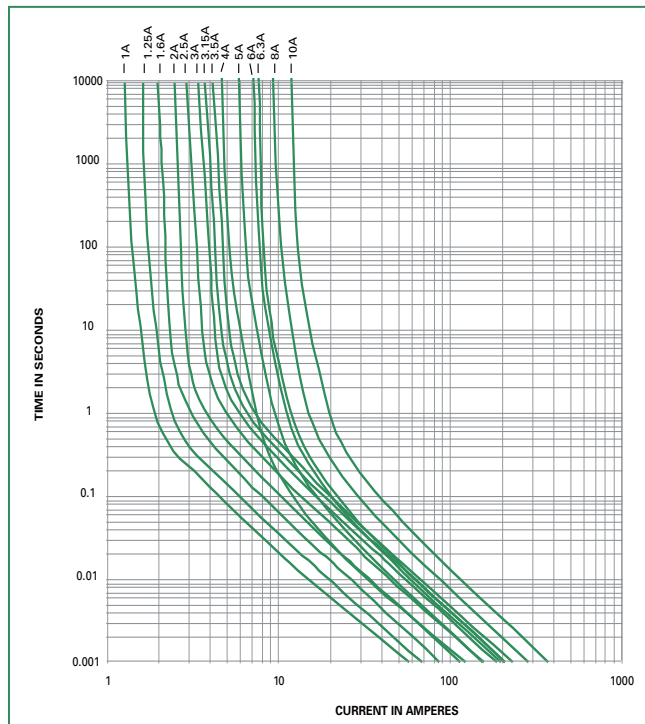

Soldering Parameters - Wave Soldering

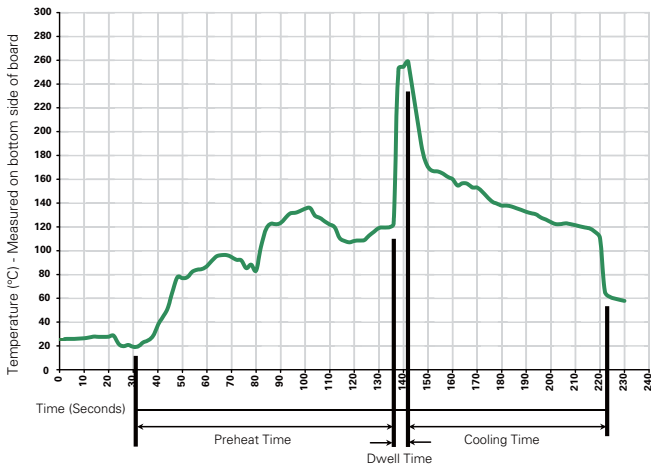

Recommended Process Parameters:

Wave Parameter	Lead-Free Recommendation
Preheat: (Depends on Flux Activation Temperature)	(Typical Industry Recommendation)
Temperature Minimum:	100° C
Temperature Maximum:	150° C
Preheat Time:	60-180 seconds
Solder Pot Temperature:	260° C Maximum
Solder Dwell Time:	2-5 seconds

Recommended Hand-Solder Parameters:

Solder Iron Temperature: 350° C +/- 5°C
Heating Time: 5 seconds max.

Note: These devices are not recommended for IR or Convection Reflow process.

Product Characteristics

Materials	Body: Glass(1A-3.5A), Ceramic(4A-10A) Cap: Nickel-plated brass Leads: Tin-plated Copper Filter: Sand (4A – 10A)
Terminal Strength	MIL-STD-202G, Method 211A, Test Condition A
Solderability	Reference IEC 60127 Second Edition 2003-01 Annex A
Product Marking	Cap 1: Brand logo, current and voltage rating Cap 2: Series and agency approval markings
Packaging	Available in Bulk (V=5, H=100, M=1000 pcs/pkg) or on Tape/Reel (MRET1=1000 pcs/reel)

Operating Temperature	-55°C to +125°C
Thermal Shock	MIL-STD-202G, Method 107G, Test Condition B: (5 cycles -65°C to +125°C)
Vibration	MIL-STD-202F Method 201A
Humidity	MIL-STD-202G, Method 103B, Test Condition A. high RH (95%) and elevated temp (40°C) for 240 hours
Salt Spray	MIL-STD-202G, Method 101D, Test Condition B

Dimensions

0234 000P

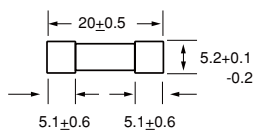

0234 000XEP

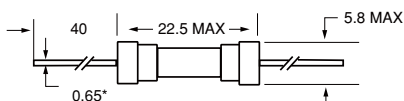

All dimensions in mm

Notes:
* Ratings above 6.3A have 0.8 mm dia lead

Part Numbering System

0234 xxxx M X P

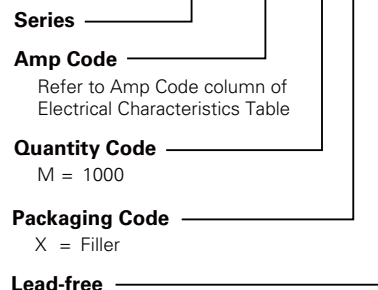

Packaging

Packaging Option	Packaging Specification	Quantity	Quantity & Packaging Code	Taping Width
234 Series				
Bulk	N/A	1000	MX	N/A
Bulk	N/A	1000	MXE	N/A
Reel and Tape	EIA 296-E	1000	MRET1	T1=52mm (2.062")

RoHS  **239 Series, 5 x 20 mm, Slo-Blo® Fuse**

Description

5x20mm time-Lag glass body cartridge fuse designed to UL specification.





Features

- Designed to UL/CSA/ ANCE 248 Standard
- Available in cartridge and axial lead format
- RoHS compliant and lead-free

Applications

Used as supplementary protection in appliance or utilization equipment to provide individual protection for components or internal circuits.





Agency Approvals

Agency	Agency File Number	Ampere Range
	Cartridge Certificates: NBK290502-E10480 G NBK280602-E10480 C NBK290502-E10480 I	1A – 3.5A 4A & 5A 7A
	Leaded Certificates: NBK290502-E10480 H NBK280602-E10480 D NBK290502-E10480 J	1A – 3.15A 4A & 5A 7A
	Certificates: SU05001 – 2004A SU05001 – 2014A	200mA – 3.15A 4A – 7A
	Listed File: E10480 Guide: JDYX	80mA – 7A
	File: 029862 Certificates Class: LR1422-01	200mA – 3.15A 4A – 7A
		80mA – 7A

Electrical Characteristics for Series

% of Ampere Rating	Ampere Ratings	Opening Time
100%	All Ratings	4 hours, Minimum
135%		1 hour, Maximum
200%		5 seconds., Min; 2 min., Max

Electrical Characteristic Specification by Item

Amp Code	Amp Rating (A)	Voltage Rating (V)	Interrupting Rating	Nominal Cold Resistance (Ohms)	Nominal Melting I^2t (A ² sec)	Agency Approvals				
										
.080	0.08	250	35A @ 125 VAC	28.1750	0.02500	x				x
.100	0.1	250		17.3425	0.05500	x				x
.125	0.125	250		11.6000	0.08500	x				x
.150	0.15	250	35A @ 125 VAC 10000A @ 125 VAC	8.1000	0.13000	x				x
.200	0.2	250		3.8725	0.16500	x	x		x	x
.250	0.25	250		3.0700	0.34000	x	x		x	x
.300	0.3	250		2.3000	0.61500	x	x		x	x
.400	0.4	250		1.4750	1.49000	x	x		x	x
.500	0.5	250		0.9090	1.98500	x	x		x	x
.600	0.6	250		0.6990	2.41500	x	x		x	x
.700	0.7	250		0.5375	4.12000	x	x		x	x
.750	0.75	250		0.4710	5.42500	x	x		x	x
.800	0.8	250		0.4155	7.56500	x	x		x	x
001.	1	250		0.2965	11.29500	x	x	x	x	x
1.25	1.25	250		0.1980	19.52500	x	x	x	x	x
01.6	1.6	250	0.1205	30.43000	x	x	x	x	x	
002.	2	250	0.0943	50.58500	x	x	x	x	x	
02.5	2.5	250	10000A @ 125 VAC 100A @ 250 VAC	0.0583	79.70500	x	x	x	x	x
003.	3	250		0.04877	129.51000	x	x	x	x	x
3.15	3.15	250		0.0414	128.05000	x	x	x	x	x
03.2	3.2	250		0.0385	128.05000	x		x		x
03.5	3.5	250		0.0370	128.05000	x		x		x
004.	4	125		0.0312	270.703	x	x	x	x	x
005.	5	125	10000A @ 125 VAC	0.0199	302.836	x	x	x	x	x
007.	7	125		0.0114	305.758	x	x	x	x	x

Temperature Derating Curve

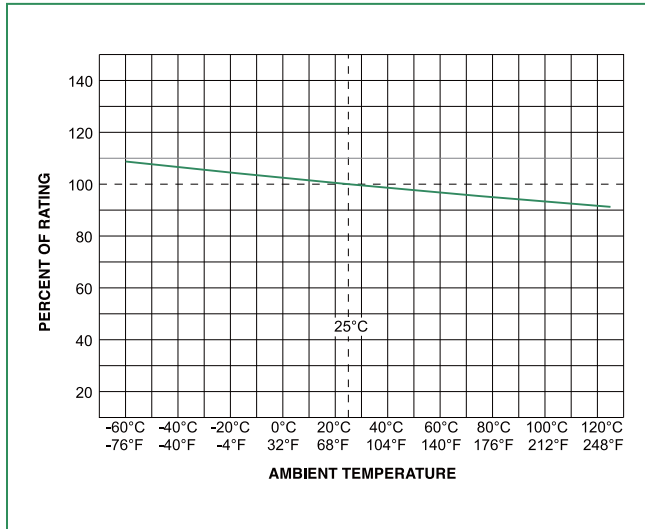

Average Time Current Curves

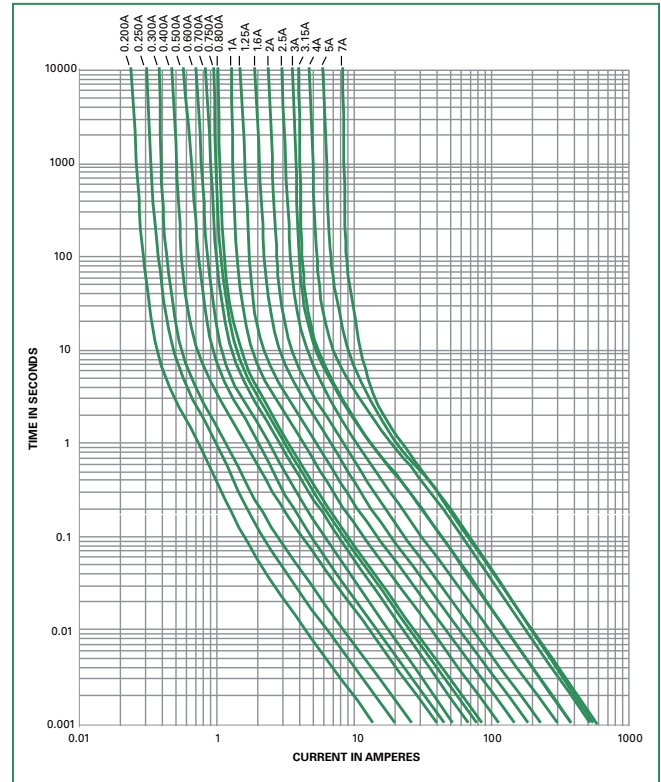

Soldering Parameters - Wave Soldering

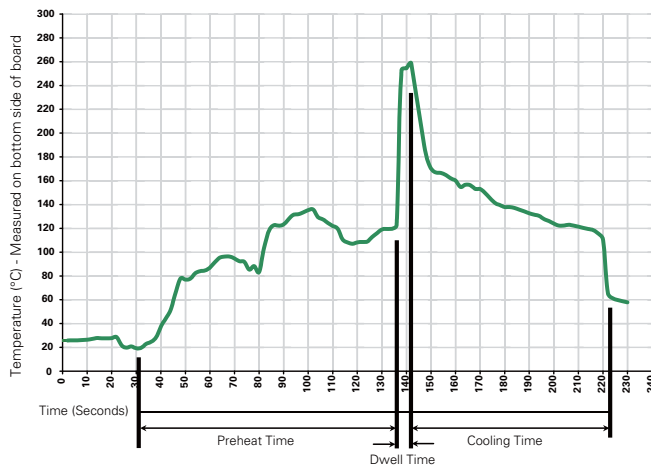

Recommended Process Parameters:

Wave Parameter	Lead-Free Recommendation
Preheat: (Depends on Flux Activation Temperature) (Typical Industry Recommendation)	
Temperature Minimum:	100° C
Temperature Maximum:	150° C
Preheat Time:	60-180 seconds
Solder Pot Temperature:	260° C Maximum
Solder Dwell Time:	2-5 seconds

Recommended Hand-Solder Parameters:

Solder Iron Temperature: 350° C +/- 5° C
 Heating Time: 5 seconds max.

Note: These devices are not recommended for IR or Convection Reflow process.

Product Characteristics

Materials	Body: Glass Cap: Nickel-plated brass Leads: Tin-plated Copper
Terminal Strength	MIL-STD-202G, Method 211A, Test Condition A
Solderability	Reference IEC 60127 Second Edition 2003-01 Annex A
Product Marking	Cap 1: Brand logo, current and voltage rating Cap 2: Series and agency approval markings

Operating Temperature	-55°C to +125°C
Thermal Shock	MIL-STD-202G, Method 107G, Test Condition B: (5 cycles -65°C to +125°C)
Vibration	MIL-STD-202G, Method 201A
Humidity	MIL-STD-202G, Method 103B, Test Condition A. high RH (95%) and elevated temp (40°C) for 240 hours
Salt Spray	MIL-STD-202G, Method 101D, Test Condition B

Dimensions

0239 000P

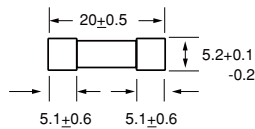

0239 000XEP

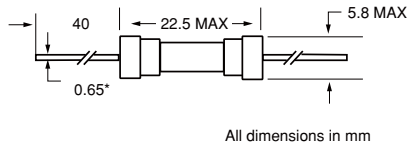

Notes:
* Ratings above 6.3A
have 0.8 mm dia lead

Part Numbering System

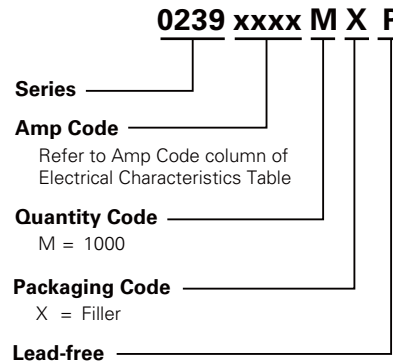

Packaging

Packaging Option	Packaging Specification	Quantity	Quantity & Packaging Code	Taping Width
239 Series				
Bulk	N/A	1000	MXE	N/A
Bulk	N/A	1000	MXB	N/A
Reel and Tape	EIA 296-E	1000	MRET1	T1=52mm (2.062)

RoHS  **477 Series, 5 x 20 mm, Time-Lag (Slo-Blo®) Fuse**







Description

400Vdc/500Vac rated, 5x20mm, time-lag, surge withstand ceramic body cartridge fuse.

Features

- Designed to International (IEC) Standards for use globally
- Available in cartridge and axial lead form
- Follow the IEC 60127-2, Sheet 5 specification for time-lag fuses
- RoHS compliant and lead-free

Agency Approvals

Agency	Agency File Number	Ampere Range
	Cartridge Certificates: NBK080306-JP1021 A NBK080306-JP1021 B NBK100408-JP1021 A	1A – 5A 6.3A – 12A 16A
	Leaded Certificates: NBK030805-E10480 D NBK030805-E10480 F NBK100408-JP1021 B	1A – 5A 6.3A – 12A 16A
	Cartridge File: No.806815	500mA – 8A
	Leaded File: No.811247	
	Recognised File: E10480	500mA – 16A(500VAC) 500mA – 16A(400VDC)
	Certificate No.: 40025413	1A & 3.15A(500VAC) 1A & 3.15A(400VDC)
		500mA – 16A

Applications

High energy and power efficient applications.

Electrical Characteristics for Series

% of Ampere Rating	Ampere Rating	Opening Time
150%	.5 – .8	60 minutes, Minimum
	1 – 3.15	60 minutes, Minimum
	4 – 6.3	60 minutes, Minimum
210%	8 – 16	30 minutes, Minimum
	.5 – .8	30 minutes, Maximum
	1 – 3.15	30 minutes, Maximum
275%	4 – 6.3	30 minutes, Maximum
	8 – 16	30 minutes, Maximum
	.5 – .8	.25 sec., Min.; 80 sec., Max.
400%	1 – 3.15	.75 sec., Min.; 80 sec., Max.
	4 – 6.3	.75 sec., Min.; 80 sec., Max.
	8 – 16	.75 sec., Min.; 80 sec., Max.
1000%	.5 – .8	.05 sec., Min.; 5 sec., Max.
	1 – 3.15	.095 sec., Min.; 5 sec., Max.
	4 – 6.3	.15 sec., Min.; 5 sec., Max.
1000%	8 – 16	.15 sec., Min.; 5 sec., Max.
	.5 – .8	.005 sec., Min.; .15 sec., Max.
	1 – 3.15	.01 sec., Min.; .15 sec., Max.
1000%	4 – 6.3	.01 sec., Min.; .15 sec., Max.
	8 – 16	.01 sec., Min.; .15 sec., Max.

477 Series

Electrical Characteristics Specifications by Item

Amp Code	Amp Rating	Max Voltage Rating (V)		Interrupting Rating				Nominal Cold Resistance (Milli-Ohm)	Nominal Melting I ² T (A ² Sec.)	Agency Approvals			
				Voltage (V)		Current (A)				UL	CS	VDE	
		AC	DC	AC	DC	AC	DC						
.500*	0.5*	500	400	500	400	100	1500	1055.900	0.300		X	X**	
.800*	0.8*	500	400	500	400	100	1500	430.000	0.909		X	X**	
001.*	1*	500	400	500	400	100	1500	139.400	1.800	X	X	X**	X
002.*	2*	500	400	500	400	100	1500	55.200	9.120	X	X	X**	
3.15*	3.15*	500	400	500	400	100	1500	27.700	50.109	X	X	X**	X
004.*	4*	500	400	500	400	100	500	17.200	52.480	X	X	X**	
005.*	5*	500	400	500	400	100	500	13.700	76.500	X	X	X**	
06.3	6.3	500	400	500	400	100	500	10.970	121.451	X	X	X	
008.	8	500	400	500	400	100	500	8.305	203.520	X	X	X	
010.	10	500	400	500	400	100	500	4.950	610.000	X	X		
012.	12	500	400	500	400	100	500	4.730	576.000	X	X		
016.	16	500	400	500	400	100	400	3.100	1331.200	X	X		

*100A@600Vac interrupting rating witnessed by UL available for 0.5A to 5A with 600Vac markings. Add suffix "MX6EP". Example: 0477004. MX6EP.
 **Semko approval for 500Vac type only.

Temperature Derating Curve

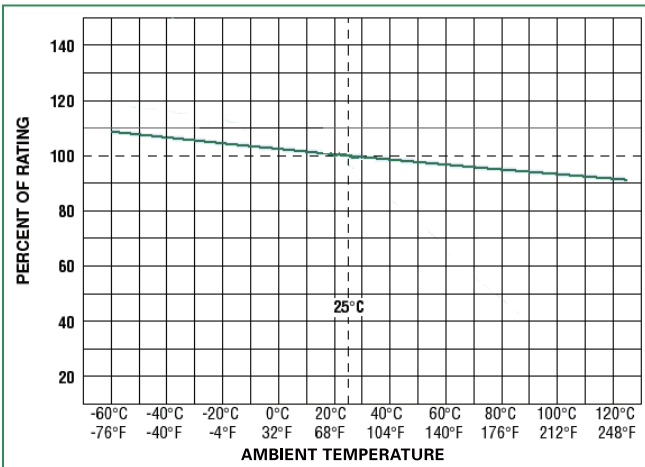

Average Time Current Curves

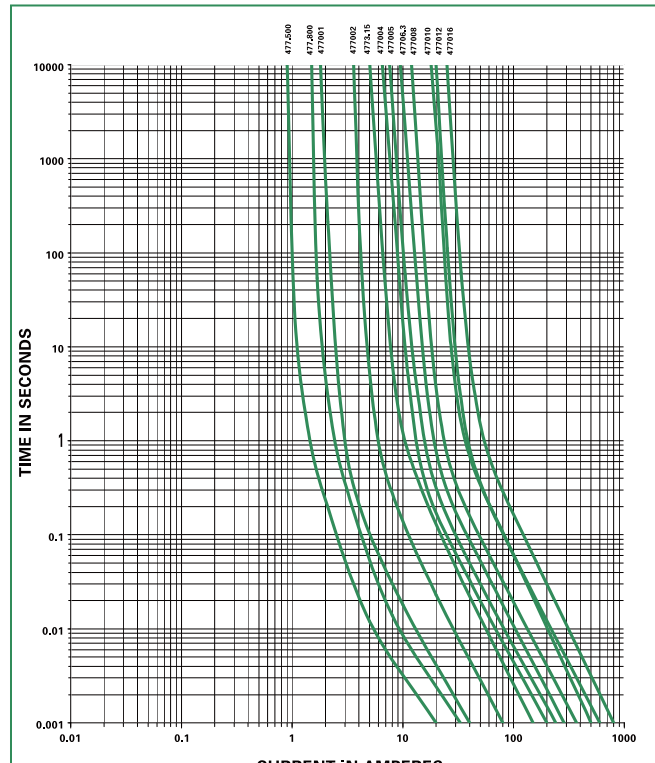

Soldering Parameters - Wave Soldering

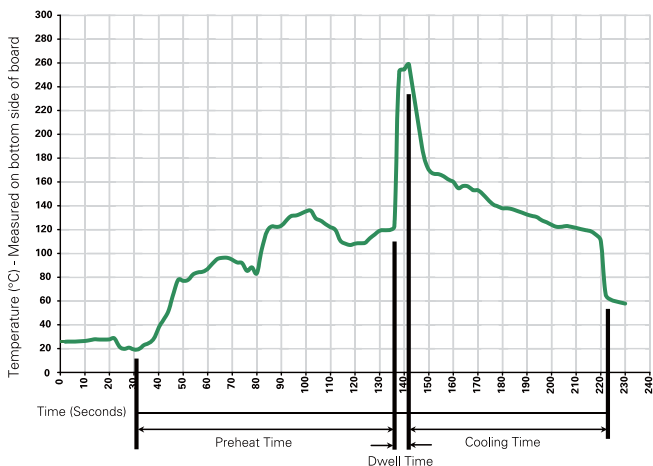

Recommended Process Parameters:

Wave Parameter	Lead-Free Recommendation
Preheat: (Depends on Flux Activation Temperature)	(Typical Industry Recommendation)
Temperature Minimum:	100° C
Temperature Maximum:	150° C
Preheat Time:	60-180 seconds
Solder Pot Temperature:	260° C Maximum
Solder Dwell Time:	2-5 seconds

Recommended Hand-Solder Parameters:

Solder Iron Temperature: 350° C +/- 5° C
Heating Time: 5 seconds max.

Note: These devices are not recommended for IR or Convection Reflow process.

Product Characteristics

Material	Body: Ceramic Cap: Nickel-plated brass Leads: Tin-plated Copper
Terminal Strength	MIL-STD-202G, Method 211A, Test Condition A
Solderability	Reference IEC 60127 Second Edition 2003-01 Annex A
Product Marking	Cap 1: Brand logo, current and voltage rating Cap 2: Series and agency approval markings
Packaging	Available in Bulk (M=1000 pcs/pkg)

Operating Temperature	-55° C to +125° C
Thermal Shock	MIL-STD-202G, Method 107G, Test Condition B: (5 cycles -65° C to +125° C)
Vibration	MIL-STD-202G, Method 201A
Humidity	MIL-STD-202G, Method 103B, Test Condition A. high RH (95%) and elevated temperature (40° C) for 240 hours
Salt Spray	MIL-STD-202G, Method 101D, Test Condition B

Dimensions

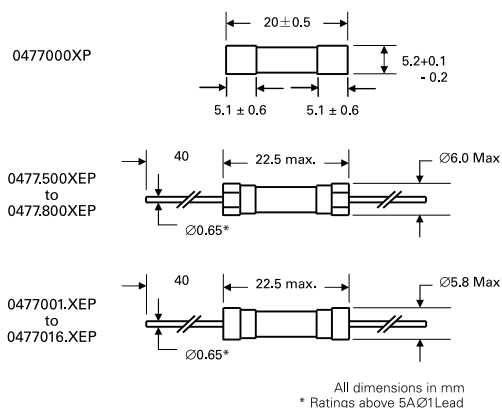

Part Numbering System

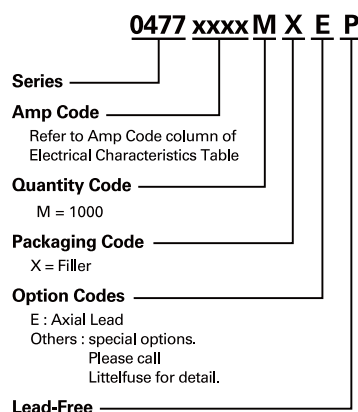

Packaging

Packaging Option	Packaging Specification	Quantity	Quantity & Packaging Code	Reel Size
477 Series				
Bulk	N/A	1000	MX	N/A
Bulk	N/A	1000	MXE	N/A

RoHS **312/318 Series** Lead-Free 3AG, Fast-Acting Fuse

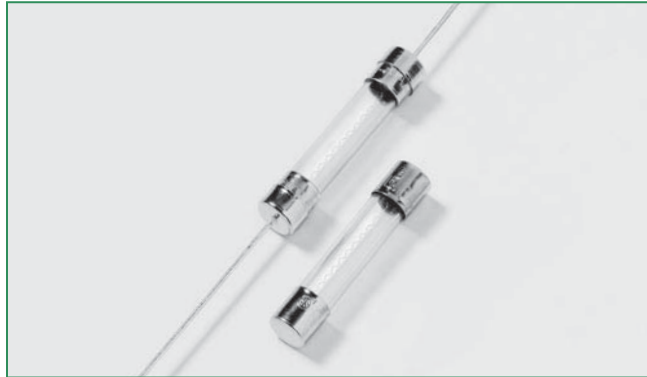

Description

The 3AG Fast-Acting Fuse solves a broad range of application requirements while offering reliable performance and cost-effective circuit protection.

Features

- In accordance with UL Standard 248-14
- Available in cartridge and axial lead format and with various forming dimensions
- RoHS compliant and Lead-free (except 10mA and 31mA rated items)

Agency Approvals

Agency	Agency File Number	Ampere Range
	E10480 AU1410	312 Series: 10mA - 10A/ 318 Series: 31mA - 10A 312 Series: 12A - 30A
	LR 29862	312 Series: 10mA - 30A 318 Series: 31mA - 10A
	NBK040205- E10480B/F	312/318 Series: 1A - 10A
	E10480	318 Series: 12A - 30A
	SU05001- 5005/5006/6005/6008	312/318 Series: 1A/ 1.25A / 1.6A/ 2A - 10A
		312 Series: 10mA - 10A 318 Series: 31mA - 10A

Applications

Used as supplementary protection in appliance or utilization equipment to provide individual protection for components or internal circuits.

Electrical Characteristics for Series

% of Ampere Rating	Ampere Rating	Opening Time
100%	10mA – 35A	4 hours, Minimum
135%	10mA – 35A	1 hour, Maximum
200%	10mA – 10A	5 sec., Maximum
	12A – 30A	10 sec., Maximum
	35A	20 sec., Maximum

312/318 Series

Electrical Characteristic Specifications by Item

Amp Code	Ampere Rating (A)	Voltage Rating (V)	Interrupting Rating	Nominal Cold Resistance (Ohms)	Nominal Melting I ² t (A ² sec)	Agency Approvals					
						UL	cURus	K	PS E	SF	CE
.10*	0.01	250	35A@250Vac 10KA@125Vac	177.4000	NA	x				x	x**
.031*	0.031	250		23.6500	0.0000300	x				x	x
.062	0.062	250		24.7000	0.000249	x				x	x
.100	0.1	250		11.2800	0.00102	x				x	x
.125	0.125	250		7.1450	0.00289	x				x	x
.150	0.15	250		5.1300	0.00550	x				x	x
.175	0.175	250		3.8750	0.00960	x				x	x
.187	0.187	250		3.4200	0.0128	x				x	x
.200	0.2	250		3.0200	0.0165	x				x	x
.250	0.25	250		2.0100	0.0355	x				x	x
.300	0.3	250		1.4050	0.0689	x				x	x
.375	0.375	250		0.8250	0.185	x				x	x
.500	0.5	250		0.4980	0.483	x				x	x
.600	.6	250		0.3620	0.880	x				x	x
.750	0.75	250		0.2445	1.84	x				x	x
001.	1	250		0.1900	0.760	x		x	x	x	x
1.25	1.25	250		0.1385	1.45	x		x	x	x	x
01.5	1.5	250	0.1036	2.35	x			x	x	x	
01.6	1.6	250	0.0934	2.80	x		x	x	x	x	
1.75	1.75	250	0.0856	3.60	x			x	x	x	
01.8	1.8	250	0.0825	3.85	x			x	x	x	
002.	2	250	0.0704	5.20	x		x	x	x	x	
2.25	2.25	250	0.0594	7.20	x		x	x	x	x	
02.5	2.5	250	0.0513	9.54	x		x	x	x	x	
003.	3	250	0.0427	14.0	x		x	x	x	x	
004.	4	250	0.0293	28.5	x		x	x	x	x	
005.	5	250	0.0224	50.0	x		x	x	x	x	
006.	6	250	0.0178	118.0	x		x	x	x	x	
007.	7	250	0.0146	118.0	x		x	x	x	x	
008.	8	250	0.0122	166.0	x		x	x	x	x	
010.	10	250	0.0093	298.0	x		x	x	x	x	
012.*	12	32	300A@32 Vac	0.0072	234.6	x	x**			x	
015.*	15	32		0.0052	490.5	x	x**			x	
020.*	20	32		0.0035	1029	x	x**			x	
025.*	25	32		0.0024	2041	x	x**			x	
030.*	30	32		0.0019	3717	x	x**			x	
035.	35	32		0.0013	7531						

NOTES:

* 10mA and 31mA are not RoHS compliant as the glass bead contains Pb.

** For 318 Series 12A to 30A, the agency approval is only cURus.

Temperature Derating Curve

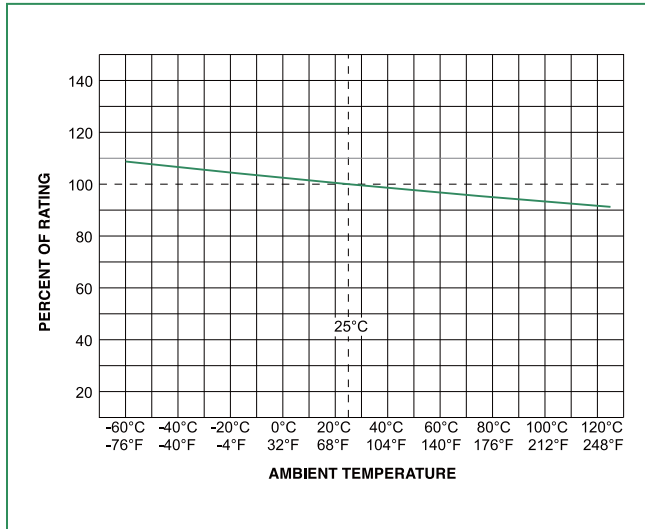

Average Time Current Curves

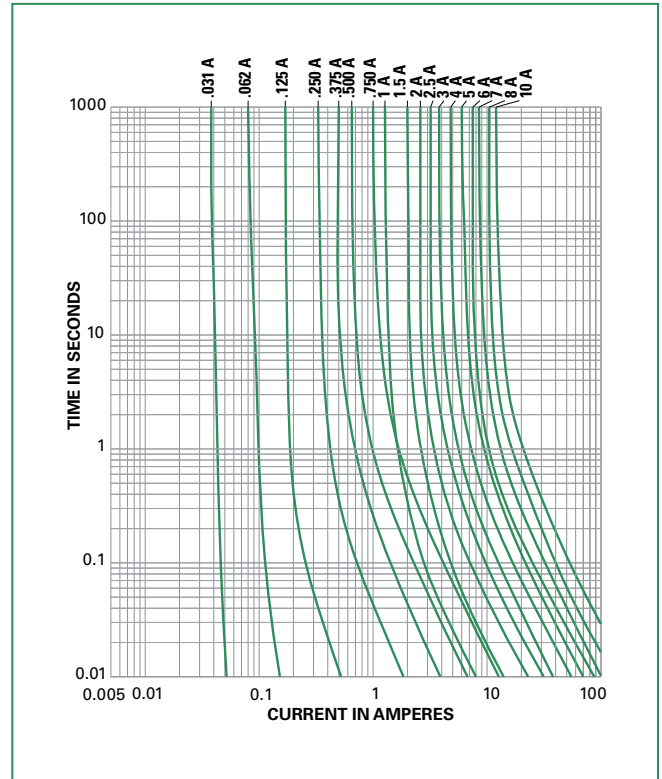

Please contact Littelfuse for more details on those T-C Curves of other ampere ratings which are not published.

Soldering Parameters - Wave Soldering

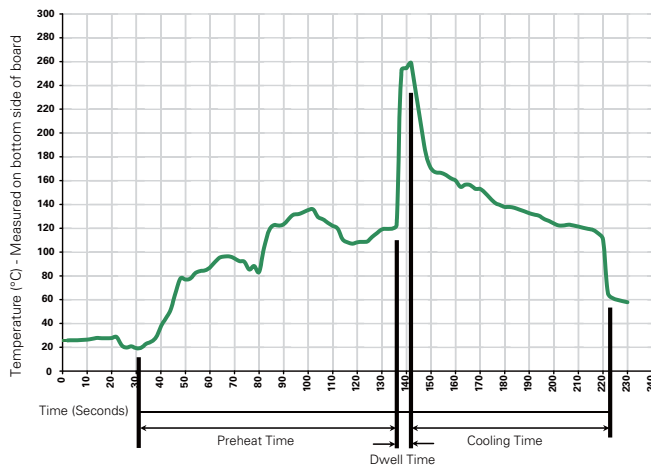

Recommended Process Parameters:

Wave Parameter	Lead-Free Recommendation
Preheat: (Depends on Flux Activation Temperature)	(Typical Industry Recommendation)
Temperature Minimum:	100° C
Temperature Maximum:	150° C
Preheat Time:	60-180 seconds
Solder Pot Temperature:	260° C Maximum
Solder Dwell Time:	2-5 seconds

Recommended Hand-Solder Parameters:

Solder Iron Temperature: 350° C +/- 5° C
 Heating Time: 5 seconds max.

Note: These devices are not recommended for IR or Convection Reflow process.

Product Characteristics

Materials	Body: Glass Cap: Nickel-plated brass Leads: Tin-plated Copper
Terminal Strength	MIL-STD-202G, Method 211A, Test Condition A
Solderability	Reference IEC 60127 Second Edition 2003-01 Annex A
Product Marking	Cap1: Brand logo, current and voltage ratings Cap2: Series and agency approval marks

Operating Temperature	-55°C to +125°C
Thermal Shock	MIL-STD-202G, Method 107G, Test Condition B: (5 cycles -65°C to +125°C)
Vibration	MIL-STD-202G, Method 201 A
Humidity	MIL-STD-202G, Method 103B, Test Condition A: High RH (95%), and Elevated temperature (40°C) for 240 hours
Salt Spray	MIL-STD-202G, Method 101D, Test Condition B

Dimensions

Measurements displayed in millimeters (inches)

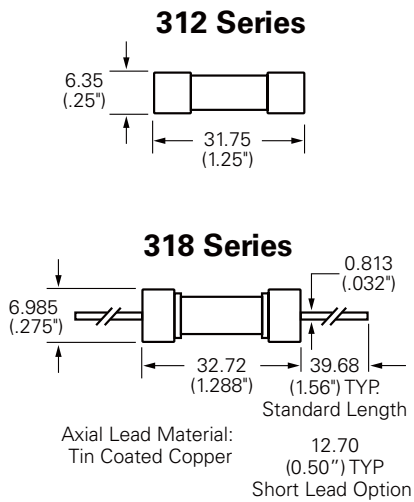

Part Numbering System

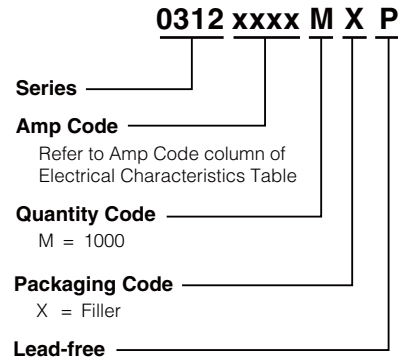

Packaging

Packaging Option	Quantity	Quantity & Packaging Code
312 Series (Cartridge Type)		
Bulk	5	VX
Bulk	100	HX
Bulk	1000	MX
Bulk	1000	MXCC
Bulk	100	HXCC
318 Series (Axial Leaded)		
Bulk	5	VX
Bulk	100	HX
Bulk	1000	MX
Bulk	1000	MXSL
Bulk	1000	MXB

RoHS  **313/315 Series Lead-Free 3AG, Slo-Blo® Fuse**

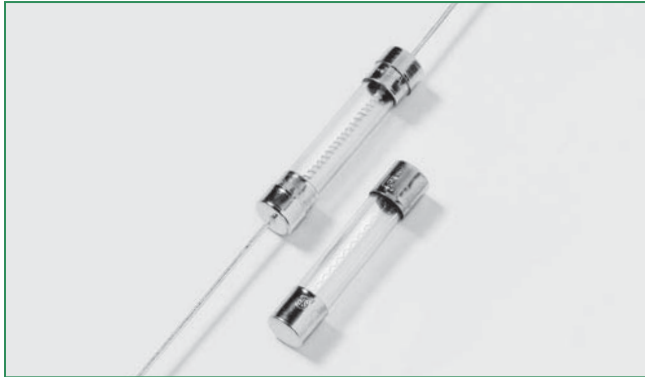







Description

The 3AG Slo-Blo® fuse solves a broad range of application requirements while offering reliable performance and cost-effective circuit protection.

The fuse catalog number with the suffix “ID” instantly identifies itself upon opening by showing a discoloration of its glass body. Guesswork and time consuming circuit testing are eliminated. This unique design offers the same quality performance characteristics as the standard 3AG Slo-Blo® Fuse design.

Agency Approvals

Agency	Agency File Number	Ampere Range
	E10480	10mA - 10A**
	LR 29862	10mA - 10A**/15A**
	E10480	10A - 30A
	NBK 040205- E10480B/D/F/G/H	1A - 10A**/ 15A**
	SU05001- 5007/5008/5009/6004	2.25A - 8A
		10mA - 10A**/15A**

Features

- In accordance with UL Standard 248-14
- Available in cartridge and axial lead format and with various forming dimensions
- RoHS compliant and Lead-free

Applications

Used as supplementary protection in appliance or utilization equipment to provide individual protection for components or internal circuits.

Electrical Characteristics by Series

% of Ampere Rating	Ampere Rating	Opening Time
100%	10mA – 30A	4 hours, Minimum
135%	10mA – 30A	1 hour, Maximum
200%	10mA – 15A	5 sec., Min., 30 sec., Max
	20A – 30A	5 sec., Min., 60 sec Max

313/315 Series

Electrical Characteristic Specifications by Item

Amp Code	Ampere Rating (A)	Voltage Rating (V)	Interrupting Rating	Nominal Cold Resistance (Ohms)	Nominal Melting I ² t (A ² sec)	Agency Approvals					
						UL	SP	CCC	RU	PS E	CE
.010	0.01	250	35A@250Vac 10KA@125Vac	4300.0000	0.000121	x	x				x
.031	0.031	250		430.0000	0.00303	x	x				x
.040	0.04	250		300.0000	0.00630	x	x				x
.062	0.062	250		120.0000	0.0210	x	x				x
.100	0.1	250		43.0000	0.0850	x	x				x
.125	0.125	250		30.0000	0.152	x	x				x
.150	0.15	250		20.0000	0.270	x	x				x
.175	0.175	250		8.6700	0.177	x	x				x
.187	0.187	250		8.0100	0.230	x	x				x
.200	0.2	250		6.5900	0.270	x	x				x
.250	0.25	250		4.2700	0.385	x	x				x
.300	0.3	250		3.1350	0.730	x	x				x
.375	0.375	250		2.0950	1.23	x	x				x
.400	0.4	250		1.8750	1.35	x	x				x
.500*	0.5	250		1.2600	2.55	x	x				x
.600	0.6	250		0.9120	4.00	x	x				x
.700	0.7	250		0.7000	5.90	x	x				x
.750	0.75	250		0.6215	7.16	x	x				x
.800	0.8	250		0.5540	8.00	x	x				x
001.*	1	250		0.3750	14.0	x	x			x	x
01.2	1.2	250	0.2780	21.5	x	x			x	x	
1.25	1.25	250	0.2600	24.0	x	x			x	x	
01.5*	1.5	250	0.1910	38.0	x	x			x	x	
01.6	1.6	250	0.1710	49.6	x	x			x	x	
01.8	1.8	250	0.1410	58.0	x	x			x	x	
002.*	2	250	0.1169	77.0	x	x			x	x	
2.25	2.25	250	0.0968	121	x	x	x		x	x	
02.5	2.5	250	0.0811	130	x	x	x		x	x	
02.8	2.8	250	0.0675	170	x	x	x		x	x	
003.*	3	250	0.0593	200	x	x	x		x	x	
03.2	3.2	250	0.0529	209	x	x	x		x	x	
004.*	4	250	0.0311	76.1	x	x	x		x	x	
005.*	5	250	0.0214	140	x	x	x		x	x	
6.25*	6.25	250	0.0154	242	x	x	x		x	x	
06.3	6.3	250	0.0154	242	x	x	x		x	x	
007.*	7	250	0.0128	347	x	x	x		x	x	
008.*	8	250	0.0111	445	x	x	x		x	x	
010.*+	10	250	0.0083	760	x	x			x	x	
010.*	10	32	0.0083	760				x			
012.	12	32	0.0065	1200				x			
015.**	15	125	0.0050	1870		x		x	x	x	
015.	15	32	0.0050	1870				x			
020.	20	32	0.0022	9560				x			
025.	25	32	0.0017	16500				x			
030.	30	32	0.0012	26900				x			

* For 313series, these ratings available with an indicating option. Add the "ID" designation to the series number. i.e. 313.500ID.

** These 2 ratings are designed for special voltage requirement. For 10A, it is available as 250Vac rated and the part number is 0313010.MX250P; for 15A, it is available as 125Vac rated and the part number is 0315015.MX125P.

Temperature Derating Curve

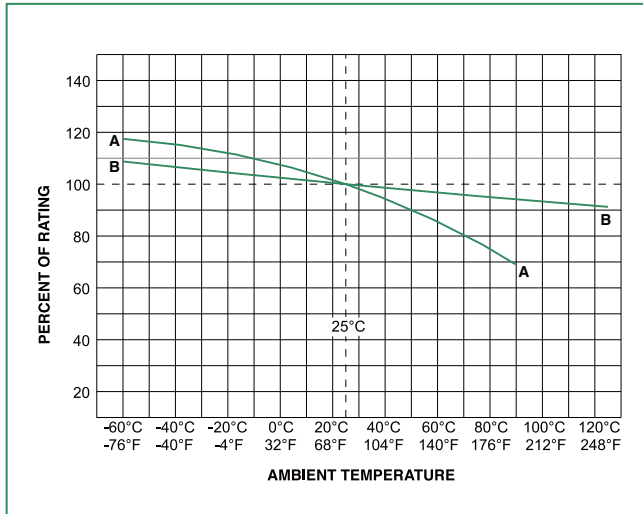

- A - For 313/315 Series, from 10mA to 150mA
- B - For all other ampere ratings of 313/315 series

Average Time Current Curves

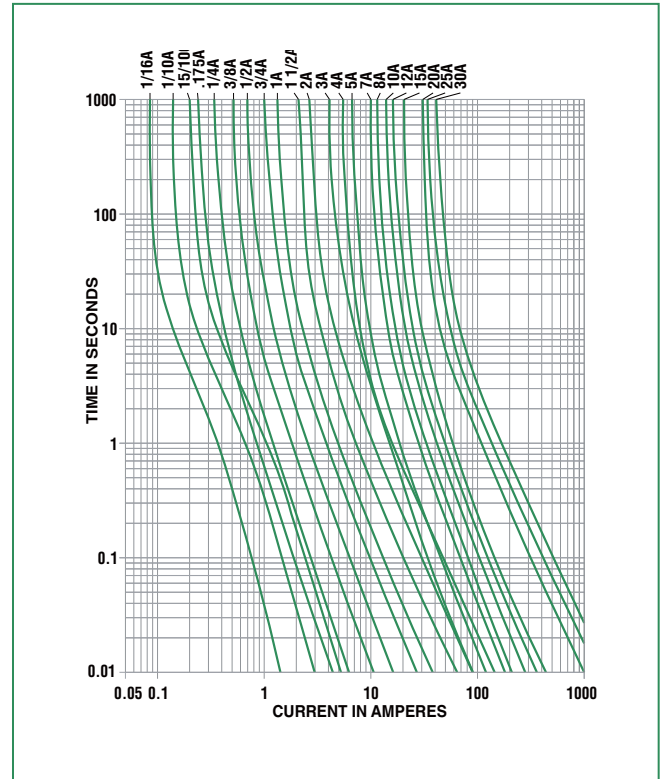

Soldering Parameters - Wave Soldering

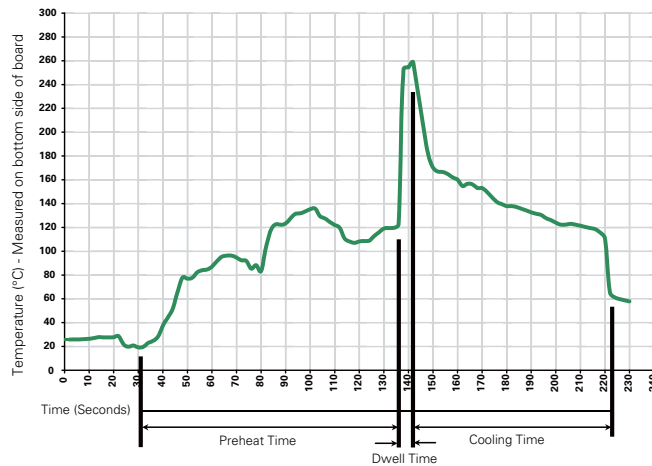

Recommended Process Parameters:

Wave Parameter	Lead-Free Recommendation
Preheat: (Depends on Flux Activation Temperature) (Typical Industry Recommendation)	
Temperature Minimum:	100° C
Temperature Maximum:	150° C
Preheat Time:	60-180 seconds
Solder Pot Temperature:	260° C Maximum
Solder Dwell Time:	2-5 seconds

Recommended Hand-Solder Parameters:

Solder Iron Temperature: 350° C +/- 5° C
Heating Time: 5 seconds max.

Note: These devices are not recommended for IR or Convection Reflow process.

Product Characteristics

Materials	Body: Glass Cap: Nickel-plated brass Leads: Tin-plated Copper
Terminal Strength	MIL-STD-202G, Method 211A, Test Condition A
Solderability	Reference IEC 60127 Second Edition 2003-01 Annex A
Product Marking	Cap1: Brand logo, current and voltage ratings Cap2: Series and agency approval marks

Operating Temperature	-55°C to +125°C
Thermal Shock	MIL-STD-202G, Method 107G, Test Condition B: (5 cycles -65°C to +125°C)
Vibration	MIL-STD-202G, Method 201 A
Humidity	MIL-STD-202G, Method 103B, Test Condition A: High RH (95%) and Elevated temperature (40°C) for 240 hours
Salt Spray	MIL-STD-202G, Method 101D, Test Condition B

Dimensions

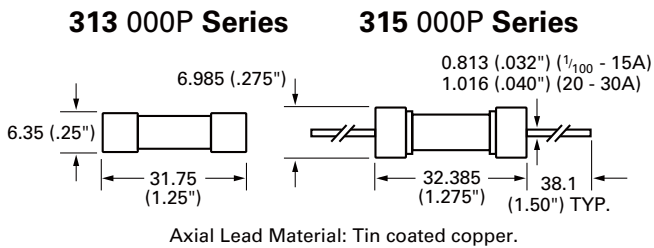

Part Numbering System

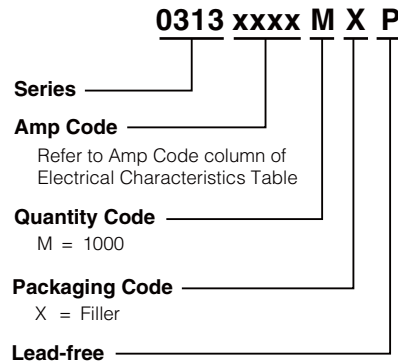

Packaging

Packaging Option	Packaging Specification	Quantity	Quantity & Packaging Code	Reel Size
313 Series				
Bulk	N/A	5	VX	N/A
Bulk	N/A	100	HX	N/A
Bulk	N/A	100	HXID	N/A
Bulk	N/A	1000	MX	N/A
Bulk	N/A	1000	MX250	N/A
Bulk	N/A	100	HXCCD	N/A
Bulk	N/A	100	VXID	N/A
315 Series				
Bulk	N/A	5	VX	N/A
Bulk	N/A	100	HX	N/A
Bulk	N/A	1000	MX	N/A
Bulk	N/A	1000	MX125	N/A
Bulk	N/A	1000	MXB	N/A
Bulk	N/A	100	HXB	N/A
Bulk	N/A	1000	MXBB	N/A
Bulk	N/A	1000	MXSL	N/A
Bulk	N/A	1000	MXB	N/A
Bulk	N/A	1000	MXSL	N/A

RoHS **Pb** **314/324 Series Lead-free 3AB, Fast-Acting Fuse**

Description

The 3AB Fast-Acting Fuse with ceramic body construction permits higher interrupting ratings and voltage ratings. Ideal for applications where high current loads are expected.

Features

- In accordance with UL Standard 248-14
- Available in cartridge and axial lead format and with various forming dimensions
- RoHS compliant and Lead-free

Applications

Used as supplementary protection in appliance or utilization equipment to provide individual protection for components or internal circuits.

Agency Approvals

Agency	Agency File Number	Ampere Range
	E10480	125mA - 15A
	LR 29862	125mA - 20A
	E10480	15A* - 40A
	NBK 030805 - E10480A-F NBK 260106 - JP1021A/B	125mA - 30A
	SU05001 - 6001/6002/6003/7006	125mA - 30A
		125mA - 30A

Electrical Characteristics for Series

% of Ampere Rating	Ampere Rating	Opening Time
100%	1/8 - 40	4 hours, Minimum
135%	1/8 - 30	1 hour, Maximum
200%	1/8 - 12	15 secs., Maximum
	15 - 30	30 secs., Maximum
250%	40	30 secs., Maximum

Electrical Specification by Item

Amp Code	Ampere Rating (A)	Voltage Rating (V)	Interrupting Rating	Nominal Cold Resistance (Ohms)	Nominal Melting I ² t (A ² sec)	Agency Approvals						
.125	0.125	250	35 A @ 250 VAC 10 kA @ 125 VAC 10 kA @ 125 VDC	6.20	0.00149	x	x				x	
.250	0.25	250		1.95	0.0140	x	x				x	
.375	0.375	250		0.820	0.050	x	x				x	
.500	0.5	250		0.500	0.115	x	x				x	
.750	0.75	250		0.250	0.466	x	x				x	
001.	1	250	100 A @ 250 VAC 10 kA @ 125 VAC 10 kA @ 125 VDC	0.189	0.690	x	x				x	
002.	2	250		0.0700	11.0	x	x				x	
003.	3	250		0.0432	14.6	x	x	x			x	
004.	4	250		0.0470	10.4	x	x	x			x	
005.	5	250	750 A @ 250 VAC 10 kA @ 125 VAC 10 kA @ 125 VDC	0.0300	26.0	x	x	x			x	
006.	6	250		0.0240	45.0	x	x	x			x	
007.	7	250		0.0187	71.0	x	x	x			x	
008.	8	250		0.0153	105	x	x	x			x	
010.	10	250		0.0105	206	x	x	x			x	
012.	12	250		0.00760	570	x	x	x			x	
015.	15	250		0.00505	292	x	x	x			x	
015.*	15	280		0.00505	292						x	
020.	20	250		1000 A @ 250 VAC 200 A @ 300 VAC 10 kA @ 125 VAC 10 kA @ 125 VDC	0.00355	631		x	x	x		x
020.*	20	280			0.00355	631					x	x
025.	25	250	100 A @ 250 VAC 1000A @ 75 VDC 400A @ 125 VAC 400 A @ 125 VDC	0.00235	1450			x	x	x	x	
025.**	25	280		0.00235	1450					x	x	
030.	30	250		0.00182	2490			x	x	x	x	
040.	40	250	1000 A @ 250 VAC 400 A @ 150 VDC	0.0014	22925				x		x	

* 350A@280VAC interrupting rating available for 15A and 20A. ** 50A@280VAC for 25A. Add suffix '280'. Example: 0324020.MX280P

Temperature Derating Curve

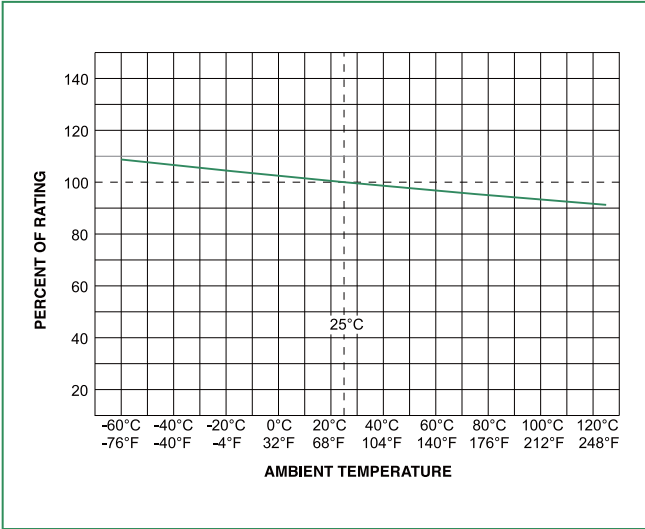

Average Time Current Curves

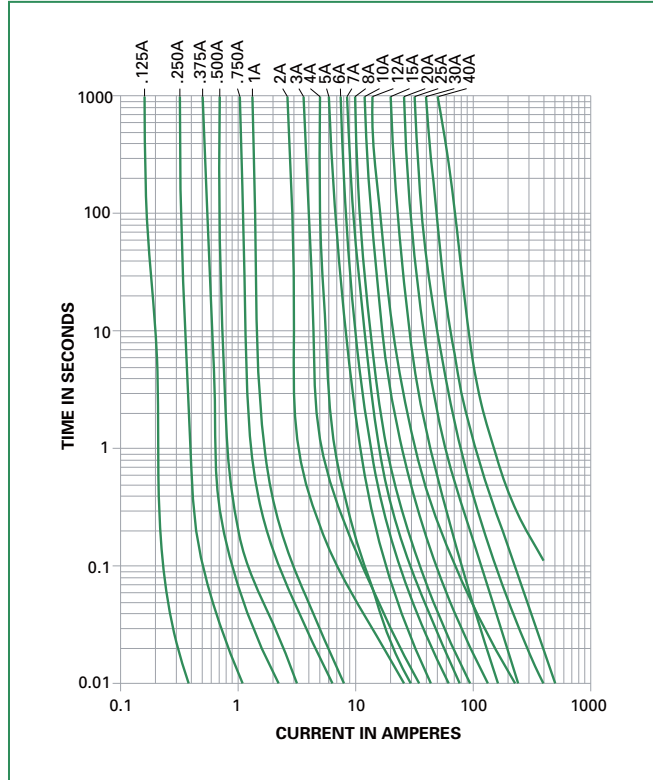

Soldering Parameters - Wave Soldering

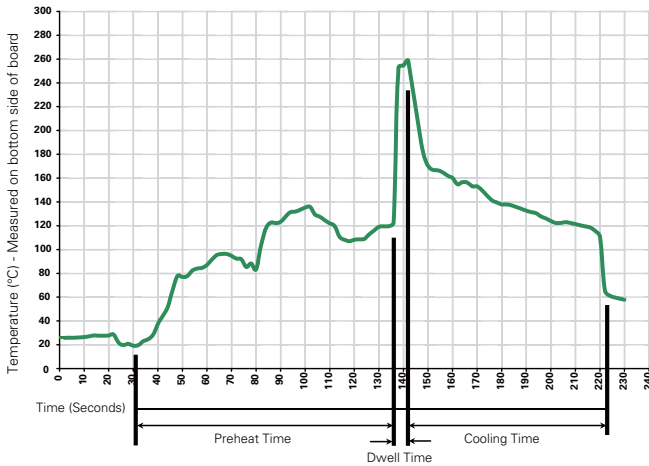

Recommended Process Parameters:

Wave Parameter	Lead-Free Recommendation
Preheat: (Depends on Flux Activation Temperature)	(Typical Industry Recommendation)
Temperature Minimum:	100° C
Temperature Maximum:	150° C
Preheat Time:	60-180 seconds
Solder Pot Temperature:	260° C Maximum
Solder Dwell Time:	2-5 seconds

Recommended Hand-Solder Parameters:

Solder Iron Temperature: 350° C +/- 5° C
Heating Time: 5 seconds max.

Note: These devices are not recommended for IR or Convection Reflow process.

Product Characteristics

Materials	Body: Ceramic Cap: Nickel-plated Brass Leads: Tin-plated Copper
Terminal Strength	MIL-STD-202G, Method 211A, Test Condition A
Solderability	Reference IEC 60127 Second Edition 2003-01 Annex A
Product Marking	Cap1: Brand logo, current and voltage ratings Cap2: Series and agency approval marks

Operating Temperature	-55°C to +125°C
Thermal Shock	MIL-STD-202G, Method 107G, Test Condition B (5 cycles, -65°C to +125°C)
Vibration	MIL-STD-202G, Method 201 A
Humidity	MIL-STD-202G, Method 103B, Test Condition A (High RH (95%) and Elevated temperature (40°C) for 240 hours)
Salt Spray	MIL-STD-202G, Method 101D, Test Condition B

Dimensions

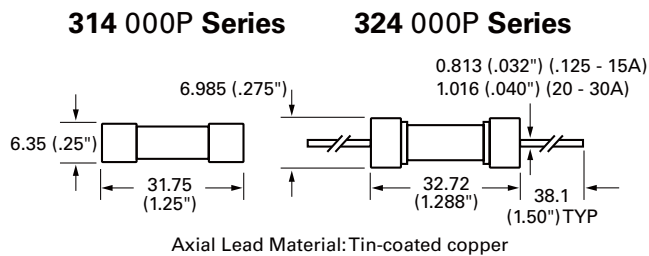

Part Numbering System

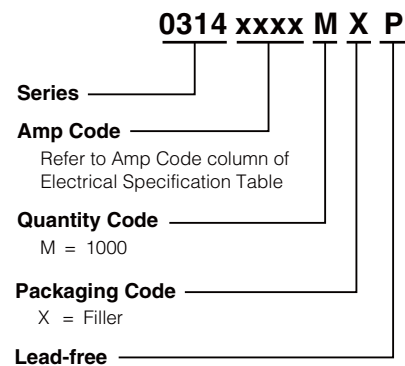

Packaging

Packaging Option	Packaging Specification	Quantity	Quantity & Packaging Code	Reel Size
314 Series				
Bulk	N/A	5	VX	N/A
Bulk	N/A	100	HX	N/A
Bulk	N/A	1000	MX	N/A
Bulk	N/A	1000	MX52L	N/A
Bulk	N/A	1000	MXCC	N/A
Bulk	N/A	1000	MX52LE	N/A
324 Series				
Bulk	N/A	5	VX	N/A
Bulk	N/A	100	HX	N/A
Bulk	N/A	1000	MX	N/A
Bulk	N/A	1000	MX280	N/A
Bulk	N/A	1000	MX52	N/A
Bulk	N/A	1000	MXF24	N/A

RoHS **Pb** **322/332 Series** Lead-free 3AB, Very Fast-acting Fuse

Description

The 3AB Very Fast-Acting Fuse for protection of Silicon Controlled Rectifiers and similar solid-state devices.

Features

- In accordance with UL Standard 248-14
- Available in cartridge format only
- RoHS compliant and Lead-free

Applications

Used as supplementary protection in appliance or utilization equipment to provide individual protection for components or internal circuits.

Agency Approvals

Agency	Agency File Number	Ampere Range
	E10480	12A - 30A
	E10480	1A - 10A
	NBK080306-JP1021A/B	1A - 10A
		1A - 30A

Electrical Characteristics for Series

% of Ampere Rating	Ampere Rating	Opening Time
100%	1 – 30	4 hours, Minimum
250%	1 – 10	.2 second, Maximum
	12 – 30	1 second, Maximum.

Electrical Characteristic Specifications by Item

Amp Code	Ampere Rating (A)	Voltage Rating (V)	Interrupting Rating	Nominal Cold Resistance (Ohms)	Nominal Melting I ² t (A ² sec)	Agency Approvals			
001.	1	250	100A@250Vac 100A@125Vdc 200A@72Vdc	0.0927	0.100	x		x	x
1.25	1.25	250		0.0804	0.156	x		x	x
002.	2	250		0.0416	0.560	x		x	x
003.	3	250		0.0245	1.890	x		x	x
004.	4	250		0.0179	3.360	x		x	x
005.	5	250		0.0128	6.250	x		x	x
006.	6	250		0.0117	8.208	x		x	x
007.	7	250		0.0108	10.58	x		x	x
008.	8	250		0.0088	16.45	x		x	x
009.	9	250		0.0077	20.66	x		x	x
010.	10	250	0.0073	24.0	x		x	x	
012.	12	65	200A@65Vac 1000A@65Vdc	0.0515	60.0		x		x
015.	15	65		0.0043	90.0		x		x
020.	20	65		0.0034	192.0		x		x
025.*	25	65		0.0029	325.0		x		x
030.*	30	65		0.0023	540.0		x		x

* Ratings from 1A to 10A are available for 332 series

* Ratings from 12A to 30A are available for 322 series, these ratings are RoHS compliant version.

Temperature Derating Curve

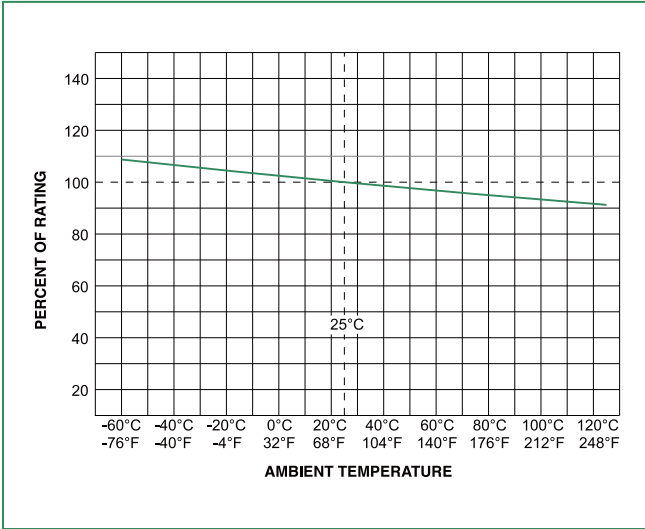

Average Time Current Curves

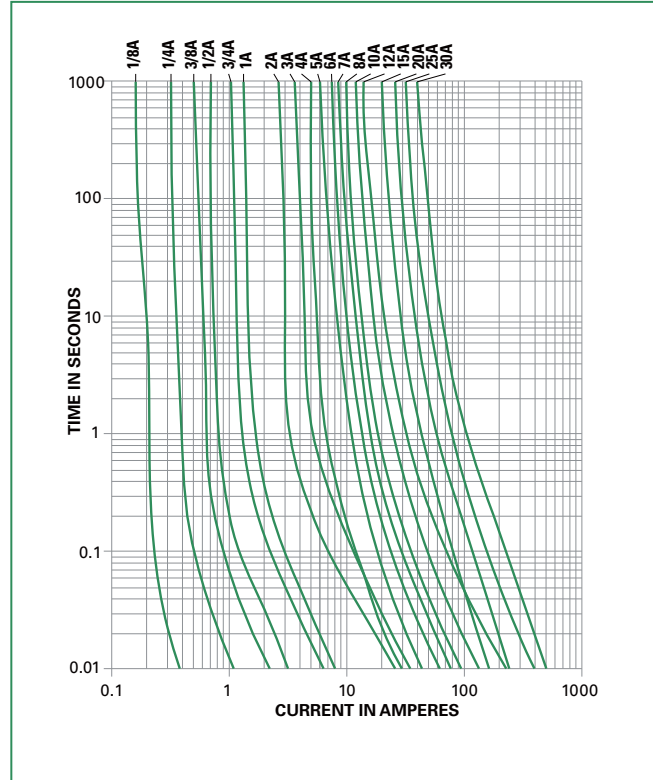

Product Characteristics

Materials	Body: Ceramic Cap: Nickel-plated brass
Terminal Strength	MIL-STD-202G, Method 211A, Test Condition A
Solderability	Reference IEC 60127 Second Edition 2003-01 Annex A
Product Marking	Cap1: Brand logo, current and voltage ratings Cap2: Series and agency approval marks

Operating Temperature	-55°C to +125°C
Thermal Shock	MIL-STD-202G, Method 107G, Test Condition B: (5 cycles -65°C to +125°C)
Vibration	MIL-STD-202G, Method 201 A
Humidity	MIL-STD-202G, Method 103B, Test Condition A: High RH (95%) and Elevated temperature (40°C) for 240 hours
Salt Spray	MIL-STD-202G, Method 101D, Test Condition B

Dimensions

322 000P / 332 000P Series

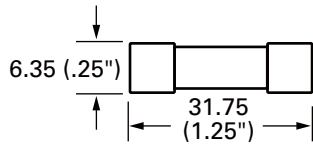

Part Numbering System

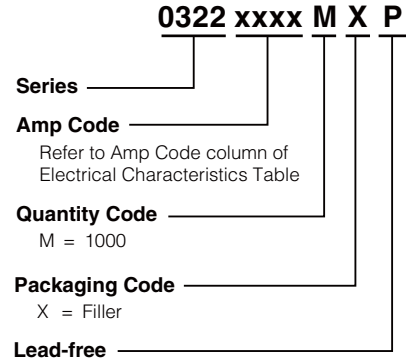

Packaging

Packaging Option	Packaging Specification	Quantity	Quantity & Packaging Code	Reel Size
322Series				
Bulk	N/A	5	VX	N/A
Bulk	N/A	100	HX	N/A
Bulk	N/A	1000	MX	N/A
332 Series				
Bulk	N/A	100	HX	N/A
Bulk	N/A	1000	MX	N/A

RoHS **325/326 Series** Lead-Free 3AB, Slo-Blo® Fuse



Description

The 3AB Slo-Blo® Fuse with ceramic body construction permits higher interrupting ratings and voltage ratings. Ideal for applications where high current loads are expected.

Features

- In accordance with UL Standard 248-14
- Available in cartridge and axial lead format and with various forming dimensions
- RoHS compliant and Lead-free

Applications

Used as supplementary protection in appliance or utilization equipment to provide individual protection for components or internal circuits.

Agency Approvals







Agency	Agency File Number	Ampere Range
	E10480	250mA - 10A
	E10480	12A - 30A
	LR 29862	250mA - 30A
	NBK 030805-E10480A-F/ NBK 260106-JP1021A/B	1A - 30A
	SU05010-5012/6006/6007/7005	2.5A - 3.2A/ 7A - 30A
		10mA - 30A

Electrical Characteristics for Series

% of Ampere Rating	Ampere Rating	Opening Time
100%	100mA – 30A	4 hours, Minimum
135%	100mA – 30A	1 hour, Maximum
200%	100mA – 3.2A	5 sec., Min., 30 sec., Max.
	4A – 30A	5 sec., Min., 60 sec., Max.

325/326 Series

Electrical Characteristic Specifications by Item

Amp Code	Ampere Rating (A)	Voltage Rating (V)	Interrupting Rating	Nominal Cold Resistance (Ohms)	Nominal Melting I ² t (A ² sec)	Agency Approvals						
												
.010	0.01	250	100A@250Vac	3324.8000	0.00148					x		
.031	0.031	250		332.5000	0.0110					x		
.062	0.062	250		91.7000	0.0276					x		
.100	0.1	250		33.5500	0.0870					x		
.125	0.125	250		22.4500	0.100					x		
.150	0.15	250		15.4500	0.143					x		
.175	0.175	250		8.9200	0.220					x		
.187	0.187	250		7.7250	0.230					x		
.200	0.2	250		6.7700	0.213					x		
.250	0.25	250		100A@250Vac 10KA@125Vac 10KA@125Vdc	4.4300	0.432			x	x	x	
.300	0.3	250	3.2200		0.690			x	x	x		
.375	0.375	250	2.1550		1.20			x	x	x		
.400	0.4	250	1.9350		1.33			x	x	x		
.500	0.5	250	1.3000		2.50			x	x	x		
.600	0.6	250	0.9495		3.90			x	x	x		
.700	0.7	250	0.7215		6.42			x	x	x		
.750	0.75	250	0.6410		7.00			x	x	x		
.800	0.8	250	0.5725		8.20			x	x	x		
001.	1	250	0.3890		16.3	x		x	x	x		
01.2	1.2	250	0.2860		22.0	x		x	x	x		
1.25	1.25	250	0.2680		24.0	x		x	x	x		
01.5	1.5	250	0.1975		40.1	x		x	x	x		
01.6	1.6	250	0.1760		45.0	x		x	x	x		
002.	2	250	0.1210		80.0	x		x	x	x		
02.5	2.5	250	0.0835		136.0	x		x	x	x	x	
02.8	2.8	250	0.0695		170.0	x		x	x	x	x	
003.	3	250	0.0605		200.0	x		x	x	x	x	
03.2	3.2	250	100A@250Vac 100KA@125Vac		0.0539	214.0	x		x	x	x	x
004.	4	250	400A@250Vac 10KA@125Vac		0.0761	9.71	x		x	x	x	
005.	5	250		0.0522	25.0	x		x	x	x		
6.25	6.25	250		0.0346	60.4	x		x	x	x		
007.	7	250		0.0227	47.3	x		x	x	x	x	
008.	8	250		0.0193	67.1	x		x	x	x	x	
010.	10	250		0.0132	137	x		x	x	x	x	
012.	12	250	400A@250Vac 10KA@125Vac 500A@60Vdc	0.0067	129	x	x	x		x	x	
012.*	12	250		0.0011	445		x	x		x		
015.	15	250		0.0050	245	x	x	x		x	x	
015.*	15	250		0.0083	760		x	x		x		
020.	20	250		0.0034	575	x	x	x		x	x	
020.*	20	250		0.0042	1900		x	x		x		
025.	25	125	400A@125Vac 10KA@60Vdc	0.0024	1030	x	x	x		x	x	
030.	30	125	600A@125Vdc	0.0019	1690	x	x	x		x	x	

*Higher I²t version available. 0325020.MXDP nominal I²t is 2507 A² Sec

Temperature Derating Curve

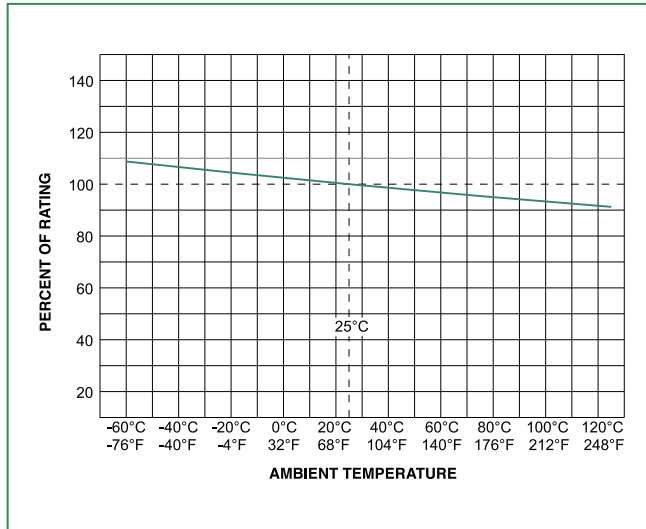

Average Time Current Curves

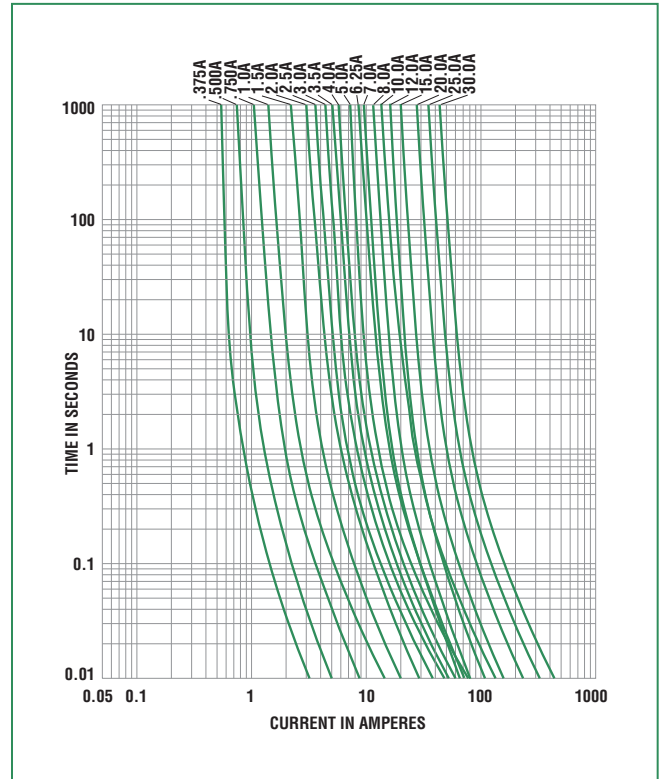

Soldering Parameters - Wave Soldering

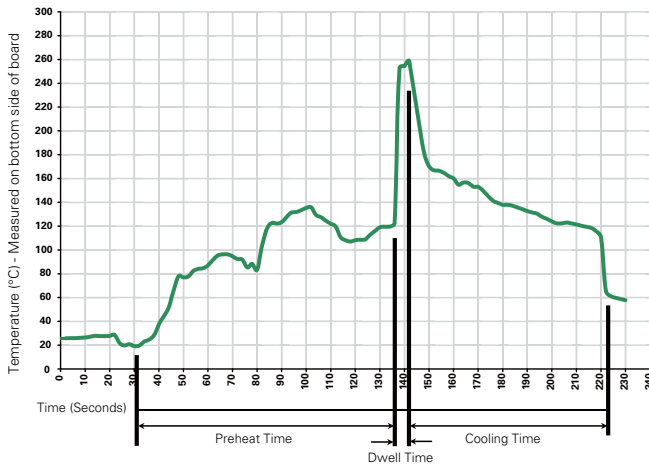

Recommended Process Parameters:

Wave Parameter	Lead-Free Recommendation
Preheat: (Depends on Flux Activation Temperature) (Typical Industry Recommendation)	
Temperature Minimum:	100° C
Temperature Maximum:	150° C
Preheat Time:	60-180 seconds
Solder Pot Temperature:	260° C Maximum
Solder Dwell Time:	2-5 seconds

Recommended Hand-Solder Parameters:

Solder Iron Temperature: 350° C +/- 5° C
Heating Time: 5 seconds max.

Note: These devices are not recommended for IR or Convection Reflow process.

Product Characteristics

Materials	Body: Ceramic Cap: Nickel-plated brass Leads: Tin-plated Copper
Terminal Strength	MIL-STD-202G, Method 211A, Test Condition A
Solderability	Reference IEC 60127 Second Edition 2003-01 Annex A
Product Marking	Cap1: Brand logo, current and voltage ratings Cap2: Series and agency approval marks

Operating Temperature	-55°C to +125°C
Thermal Shock	MIL-STD-202G, Method 107G, Test Condition B:(5 cycles - 65°C to 125°C)
Vibration:	MIL-STD-202G, Method 201A
Humidity	MIL-STD-202G, Method 103B, Test Condition A: High RH (95%) and Elevated temperature(40°C) for 240 hours
Salt Spray	MIL-STD-202G, Method 101D, Test Condition B

Dimensions

326 000P Series

325 000P Series

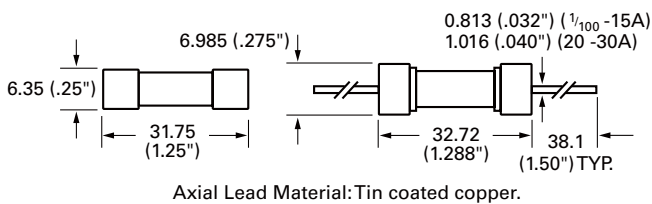

Part Numbering System

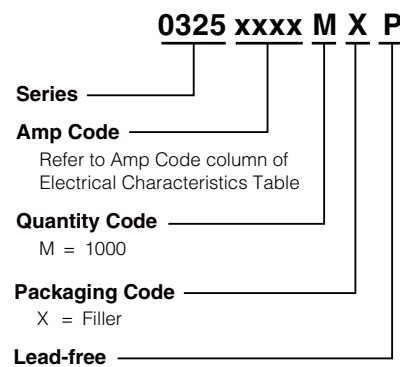

Packaging

Packaging Option	Packaging Specification	Quantity	Quantity & Packaging Code	Reel Size
325 Series				
Bulk	N/A	5	VX	N/A
Bulk	N/A	100	HX	N/A
Bulk	N/A	1000	MX	N/A
Bulk	N/A	1000	MX52	N/A
Bulk	N/A	1000	MX52L	N/A
Bulk	N/A	1000	MXD	N/A
Bulk	N/A	1000	MXF31	N/A
326 Series				
Bulk	N/A	5	VX	N/A
Bulk	N/A	100	HX	N/A
Bulk	N/A	1000	MX	N/A
Bulk	N/A	1000	MXCC	N/A
Bulk	N/A	1000	MXD	N/A

RoHS  **388 Series** Lead-Free 3AG, METI B Fuse



Description

The Littelfuse 388 Series is a 3AG size fuse that solves a broad range of application requirements while offering reliable performance and cost-effective circuit protection.

Features

- Designed to Japanese Standard JIS C6575
- Available in cartridge and axial lead form and various forming dimensions
- RoHS compliant and Lead-free



Applications

Used as supplementary protection in appliance or utilization equipment to provide individual protection for components or internal circuits.



Electrical Characteristics for Series

% of Ampere Rating	Opening Time
130	1 Hour, Minimum
160	1 hour, Maximum
200	120 seconds, Maximum

Agency Approvals

Agency	Agency File Number	Ampere Range
	NBK131107-JP1021A NBK010207-JP1021A/B/C/D	1A - 30A
	SU05001-8001 SU05001-7001/2/3/4	3A - 6A 7A/10A - 30A
		1A - 30A

Electrical Characteristic Specifications by Item

Amp Code	Amp Rating	Voltage Rating	Breaking Capacity	Nominal Resistance Cold Ohms (ohms)	Nominal Melting 2T (A2Sec.)	Agency Approvals		
								
001.	1	250	100A @ 250Vac	0.1651	0.800	x		x
01.5	1.5	250		0.0845	2.680	x		x
002.	2	250		0.0522	7.200	x		x
02.5	2.5	250		0.0375	9.540	x		x
003.	3	250		0.0313	22.10	x	x	x
004.	4	250		0.0239	28.50	x	x	x
005.	5	250		0.0184	66.10	x	x	x
006.	6	250		0.0140	116.0	x	x	x
007.	7	250		0.0127	118.0	x	x	x
008.	8	250		0.0109	166.0	x		x
009.	9	250		0.0082	298.0	x		x
010.	10	250		0.0072	234.6	x	x	x
012.	12	250		0.0052	490.5	x	x	x
015.	15	250		0.0042	1029	x	x	x
020.	20	250		0.0029	2041	x	x	x
025.	25	250		0.0019	3717	x	x	x
030.	30	250		0.0013	7531	x	x	x

¹ Depending on the application and mounting, the fuse heating at max. ambient temperature in a closed fuseholder should be considered.

p = pending

Note: 1.00 means the number one with two decimal places. 1,000 means the number one thousand.

Temperature Derating Curve

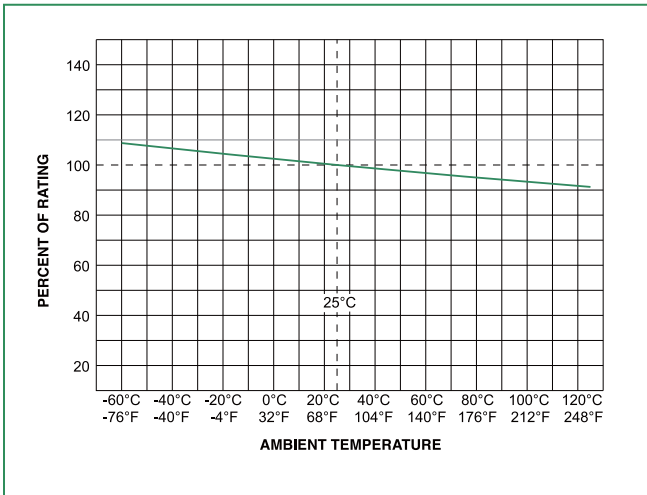

Average Time Current Curves

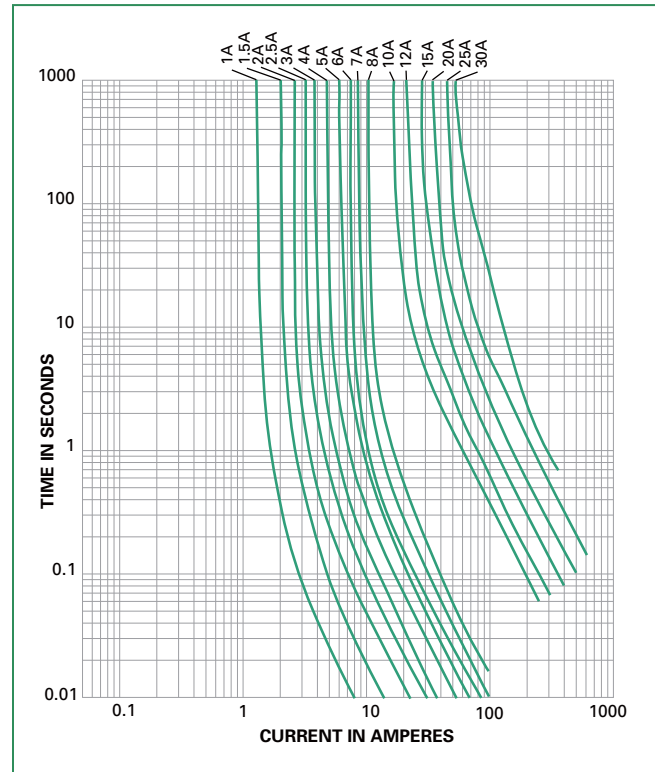

Soldering Parameters - Wave Soldering

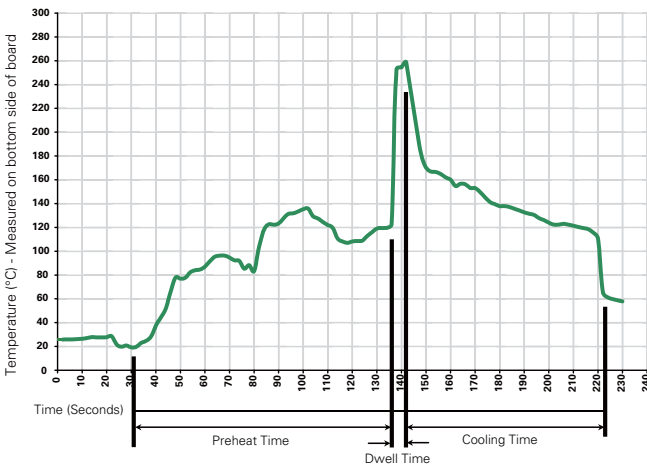

Recommended Process Parameters:

Wave Parameter	Lead-Free Recommendation
Preheat:	
(Depends on Flux Activation Temperature)	(Typical Industry Recommendation)
Temperature Minimum:	100° C
Temperature Maximum:	150° C
Preheat Time:	60-180 seconds
Solder Pot Temperature:	260° C Maximum
Solder Dwell Time:	2-5 seconds

Recommended Hand-Solder Parameters:

Solder Iron Temperature: 350° C +/- 5° C
 Heating Time: 5 seconds max.

Note: These devices are not recommended for IR or Convection Reflow process.

Product Characteristics

Materials	Body: Glass End Caps: Nickel-plated brass Leads: Tin-plated Copper
Terminal Strength	MIL-STD-202G, Method 211A, Test Condition A
Solderability	Reference IEC 60127 Second Edition 2003-2001 Annex A
Product Marking	Cap1: Brand logo, current and voltage ratings Cap2: Series and agency approval marks

Operating Temperature	-55°C to +125°C (consider de-rating)
Thermal Shock	MIL-STD-202G Method 107 G, Test condition B:(5 cycles - 65°C to 125°C)
Vibration	MIL-STD-202G, Method 201A
Humidity	MIL-STD-202G, Method 103B, Test Condition A: High RH (95%) and Elevated temperature (40°C) for 240 hours
Salt Spray	MIL-STD-202G, Method 101D, Test Condition B

Dimensions (mm)

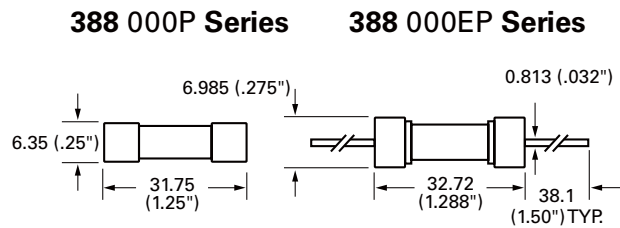

Axial Lead Material: Tin coated copper.

Part Numbering System

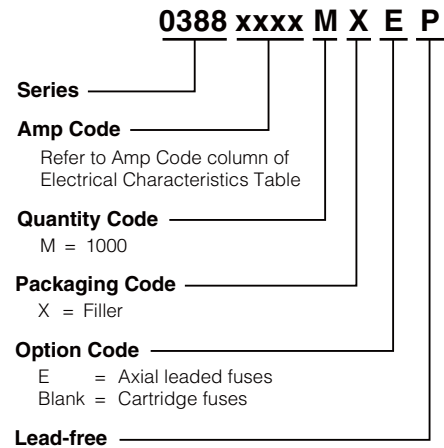

Packaging

Packaging Option	Packaging Specification	Quantity	Quantity & Packaging Code	Reel Size
388 Series				
Bulk	N/A	1000	MX	N/A
Bulk	N/A	1000	MXE	N/A

RoHS  **505 Series, Lead-free 3AB, Fast-Acting Fuse**





Description

A 500VAC/VDC rated ceramic fuse with remarkable interrupting rating in a compact 6.3 x 32mm package, which is well suited for circuit protection in high energy applications.

Features

- In accordance with underwriter's Laboratories Standard UL 248-14
- Available in cartridge and axial lead form and with various lead forming dimensions.
- RoHS compliant and Lead-free
- Superior Interrupting rating of 20,000 Amperes
- Compact form factor of 6.3 x 32mm

Agency Approvals

Agency	Agency File Number	Ampere Range
	Recognised File: E10480	10A - 30A
	813483	10A - 12A
		10A - 30A



Applications

- Uninterruptible Power Supplies (UPS)
- 3 Phase Power Supplies

Electrical Characteristics for Series

% of Ampere Rating	Ampere Rating	Opening Time
150%	10 - 30	30 minutes, Maximum
200%		30 minutes, Maximum
300%		10 sec., Maximum

Electrical Characteristics Specifications by Item

Amp Code	Amp Rating (A)	Max Voltage Rating (V)	Interrupting Rating	Nominal Cold Resistance (Ohms)	Nominal Melting I ² T (A ² Sec.)	Agency Approvals		
								
010.	10	450	20kA@450VAC 1000A@250VDC	0.0167	91	X	X	X
012.	12	450		0.0117	192	X	X	X
016.	16	500	50kA@500VAC 20kA@500VDC	0.0073	51	X		X
020.	20	500	30kA@500VAC 20kA@500VDC	0.0056	101	X		X
025.	25	500		0.0048	145	X		X
030.	30	500		0.0038	203	X		X

505 Series

Temperature Derating Curve

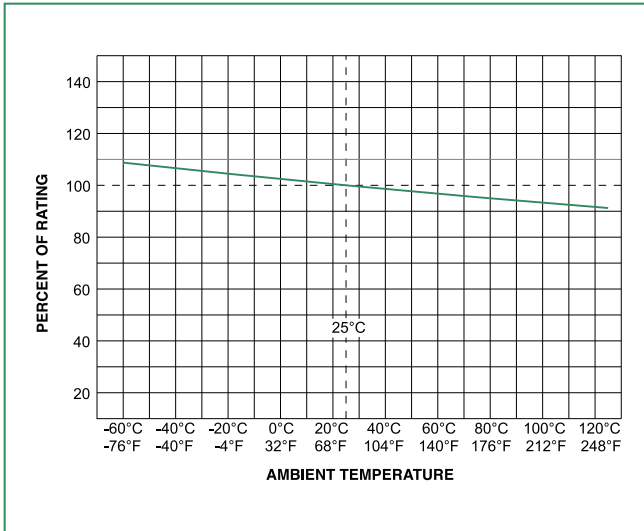

Average Time Current Curves

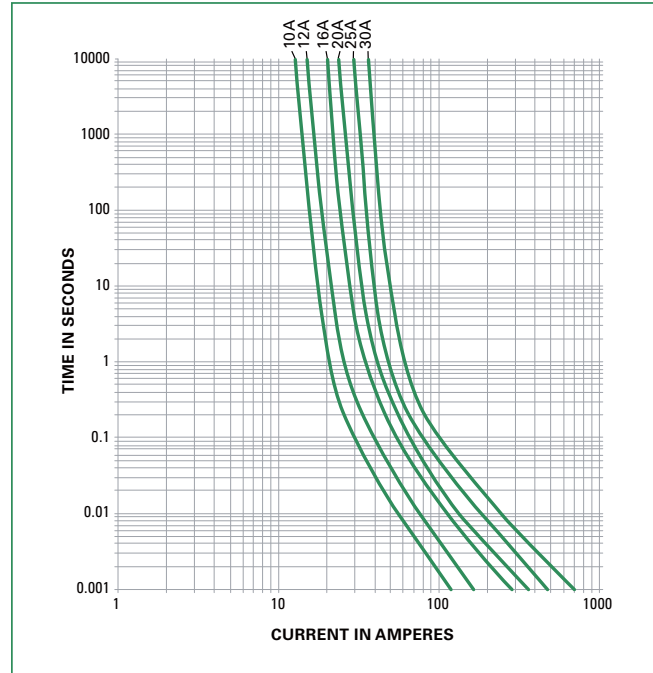

Soldering Parameters - Wave Soldering

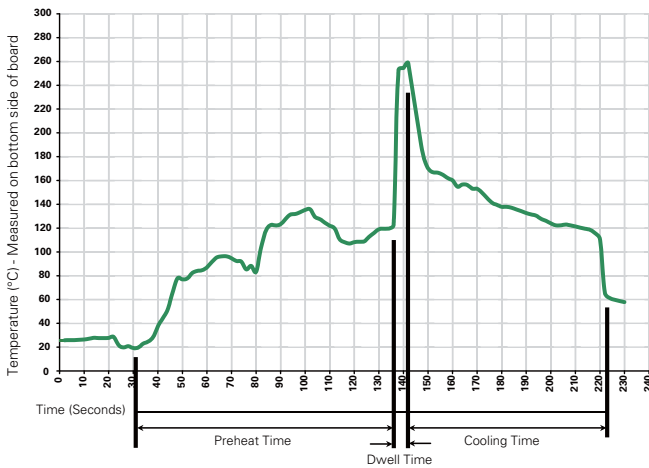

Recommended Process Parameters:

Wave Parameter	Lead-Free Recommendation
Preheat: (Depends on Flux Activation Temperature)	(Typical Industry Recommendation)
Temperature Minimum:	100° C
Temperature Maximum:	150° C
Preheat Time:	60-180 seconds
Solder Pot Temperature:	260° C Maximum
Solder Dwell Time:	2-5 seconds

Recommended Hand-Solder Parameters:

Solder Iron Temperature: 350° C +/- 5° C
 Heating Time: 5 seconds max.

Note: These devices are not recommended for IR or Convection Reflow process.

Product Characteristics

Material	Body: Ceramic Cap: Nickel-plated brass Leads: Tin-plated Copper
Terminal Strength	MIL-STD-202G, Method 211A, Test Condition A
Solderability	Reference IEC 60127 Second Edition 2003-01 Annex A
Product Marking	Cap 1: Brand logo, current and voltage rating Cap 2: Series and agency approval markings
Packaging	Available in Bulk (M=1000 pcs/pkg)

Operating Temperature	-55°C to +125°C
Thermal Shock	MIL-STD-202G, Method 107G, Test Condition B: (5 cycles -65°C to +125°C)
Vibration	MIL-STD-202G, Method 201A
Humidity	MIL-STD-202G, Method 103B, Test Condition A. high RH (95%) and elevated temperature (40°C) for 240 hours
Salt Spray	MIL-STD-202G, Method 101D, Test Condition B

Dimensions

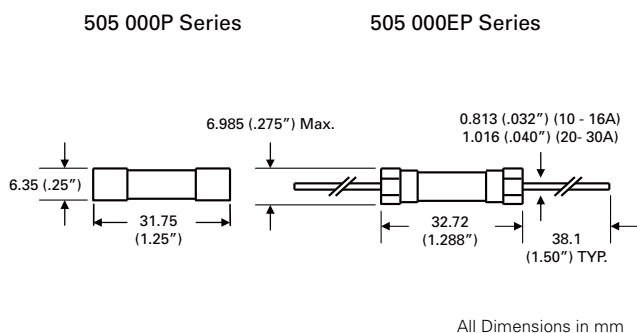

Part Numbering System

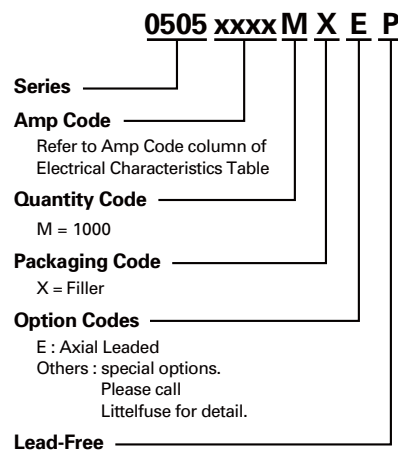

Packaging

Packaging Option	Packaging Specification	Quantity	Quantity & Packaging Code	Reel Size
505 Series				
Bulk	N/A	1000	MX	N/A
Bulk	N/A	1000	MXE	N/A

505 Series

RoHS Barrier Network Fuse 242 Series

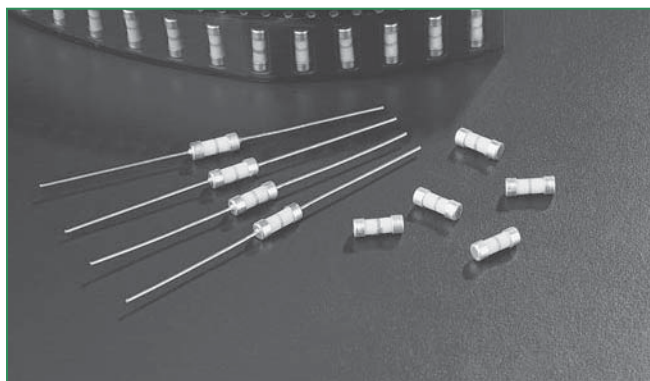

Description

The 242 Series hazardous area barrier network fuse offers a range of fuses designed to enable greater safety operating electronic equipment within potentially explosive environments.

Features

- Meets Barrier Network Standards (EN50020) for hazardous applications.
- High interrupting rating. Meets the 1500A minimum.
- Available in both axial lead and surface mount.

Applications

- Type i protected electrical equipment; Electrical connections and components, Test equipment

Agency Approvals

Agency	Agency File Number	Ampere Range
	Recognized under the components program of Underwriters Laboratories (JDYX2-10480)	0.050 - 0.250 A

Electrical Characteristics

% of Ampere Rating	Opening Time
110%	4 hours, Minimum
300%	10 seconds, Maximum
1000%	0.002 seconds, Maximum

Electrical Characteristics

Ampere Rating (A)	Amp Code	Body Color Coding	Interrupting Rating	Nominal Cold Resistance (Ohms)	Nominal Melting I ² t (A ² Sec.)	Agency Approvals 
0.050	.050	Red	4000A @ 250VAC/VDC	11.34	0.000103	x
0.080	.080	Green		8.19	0.000214	x
0.100	.100	Blue		3.60	0.000977	x
0.160	.160	Violet		3.00	0.00157	x
0.200	.200	Brown		2.68	0.0038	x
0.250	.250	Black		1.6	0.00579	x

Average Time Current Curves

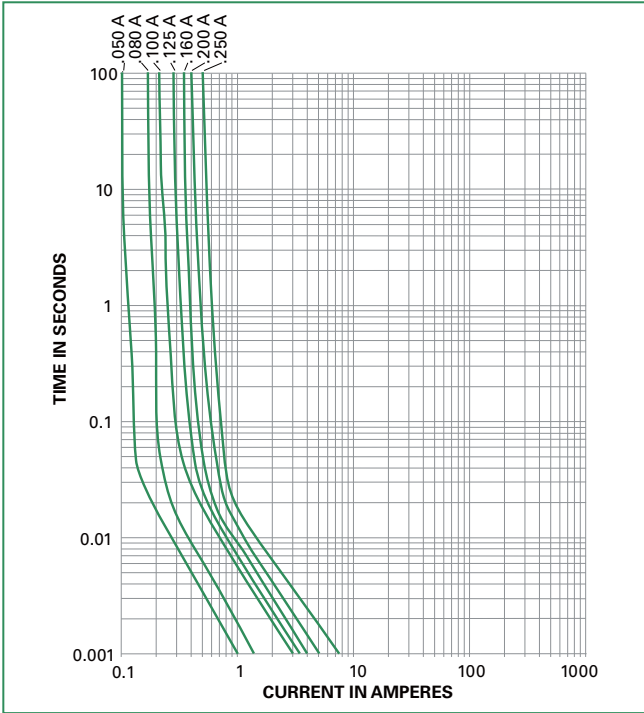

Dimensions

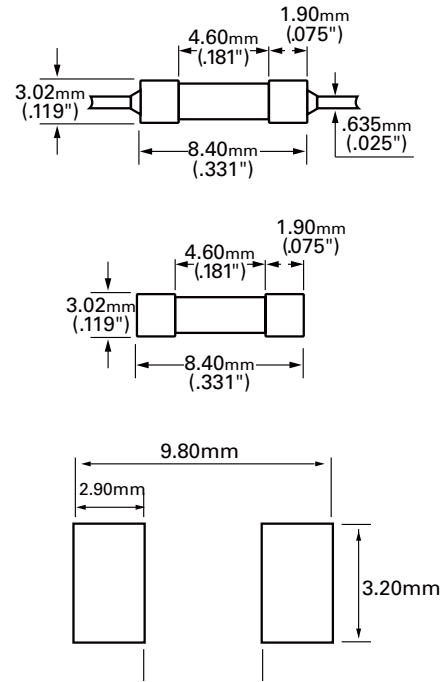

Soldering Parameters

Reflow Condition		Pb – Free assembly
Pre Heat	- Temperature Min ($T_{s(min)}$)	150°C
	- Temperature Max ($T_{s(max)}$)	200°C
	- Time (min to max) (t_s)	60 – 180 secs
Average ramp up rate (Liquidus Temp (T_L) to peak)		5°C/second max
$T_{s(max)}$ to T_L - Ramp-up Rate		5°C/second max
Reflow	- Temperature (T_L) (Liquidus)	217°C
	- Temperature (t_L)	60 – 150 seconds
Peak Temperature (T_p)		250 ^{+0/-5} °C
Time within 5°C of actual peak Temp. (t_p)		20 – 40 seconds
Ramp-down Rate		5°C/second max
Time 25°C to peak Temperature (T_p)		8 minutes Max.
Do not exceed		260°C

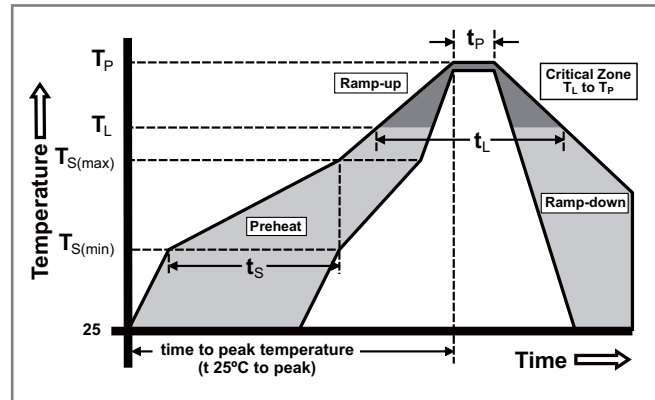

Wave Soldering	260°C, 10 seconds max.
----------------	------------------------

Product Characteristics

Operating Temperature	-40°C to 125°C.
Thermal Shock	Withstands 5 cycles of - 55°C to 125°C
Vibration	Per MIL-STD-202F
Insulation Resistance (After Opening)	Greater than 10,000 ohms.

Part Numbering System

0242.050UAT1

SERIES ————

AMP CODE ————
 Refer to Amp Code column in the Electrical Specifications table.

QUANTITY & PACKAGING CODE ————
 HAT1 = 100 pcs, Axial Leaded, Ammo Pack T1 Tape
 UAT1 = 500 pcs, Axial Leaded, Ammo Pack T1 Tape
 UR = 500 pcs, Surface Mount, Tape & Reel

RoHS Safe-T-Plus Fuse 259 Series

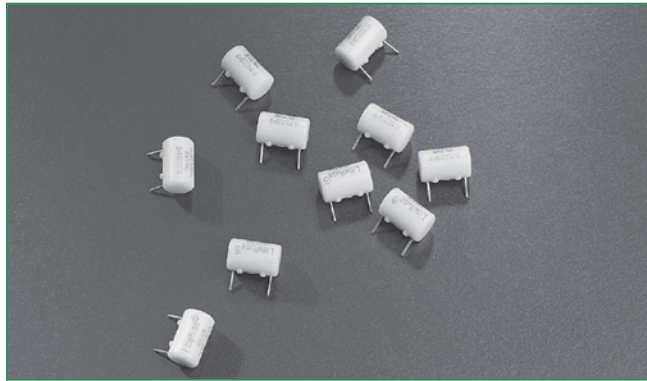

Description

The Safe-T-Plus 259 Series offers a range of encapsulated fuses designed to enable greater safety for operating electronic equipment within potentially explosive environments. Originally designed to serve the needs of gas plants, petrochemical and processing industries, these fuses are certified for use within intrinsically safe apparatus (CENELEC EN50014 to 039 and IEC 60079-11).

The encapsulation material is Polyamide 6 at a minimum depth of 1mm (3mm typically) and has a CTI (Comparative Tracking Index) of greater than 175. The leads are separated by a minimum clearance and creepage distance of 9 mm and hence are suitable for use in intrinsically safe apparatus for voltage not exceeding 125V rms (190V peak).

Agency Approvals

Agency	Agency File Number	Ampere Range
Baseefa	Baseef02ATEX0071U	62mA - 1A
	E10480	500mA, 750mA

Electrical Characteristics for Series

% of Ampere Rating	Opening Time
100%	4 Hours, Minimum
200%	5 Seconds, Maximum

Features

- Hermetically sealed
- 62mA - 5A range options
- Designed to operate within environments where there is danger of gas explosion from faulty circuits
- Meet certification for use within intrinsically safe apparatus for applications such as gas plants, petrochemical and processing industries

Applications

- Testing, measuring or processing electronic and electrical equipment

Electrical Specifications by Items

Ampere Rating (A)	Amp Code	Interrupting Rating	Nominal Cold Resistance (Ohms)	Nominal Melting I ² t (A ² Sec.)	Nom Voltage Drop (mV)	Agency Approvals	
						Baseefa	
0.062	.062	50A @ 125 VAC 300A @ 125 VDC	7.00	0.00016	2.10	x	
0.125	.125		1.70	0.0012	1.30	x	
0.250	.250		0.67	0.0095	0.83	x	
0.375	.375		0.395	0.025	0.81	x	
0.500	.500		0.302	0.0598	0.78	x	x
0.750	.750		0.175	0.153	0.23	x	x
1.00	1.00		0.128	0.256	0.24	x	
3.00	003		0.275	1.27	0.131		
5.00	005		0.0158	4.14	0.110		

Schedule of limitations:

- 1) The fuse must be so mounted that creepage and clearance distances aren't impaired in any way.
- 2) When used in intrinsically safe apparatus, it will be necessary to determine a surface temperature classification for the fuse.
- 3) Maximum surface temperature rise at 170% rated current: 750mA=40°C, 1A=45°C, 3A=63°C and 5A=114°C.

Product Characteristics

Operating Temperature	- 55°C to 90°C
Thermal Shock	Withstands 5 cycles of - 55°C to 125°C
Vibration	Per MIL-STD-202F
Insulation Resistance (After Opening)	Greater than 10,000 ohms

Soldering Parameters

Wave Soldering	260°C, 10 seconds max.
-----------------------	------------------------

Dimensions

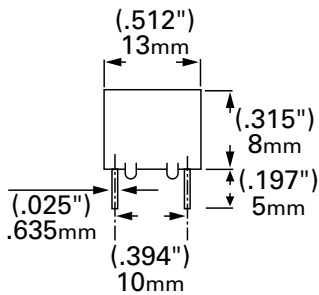

Average Time Current Curves

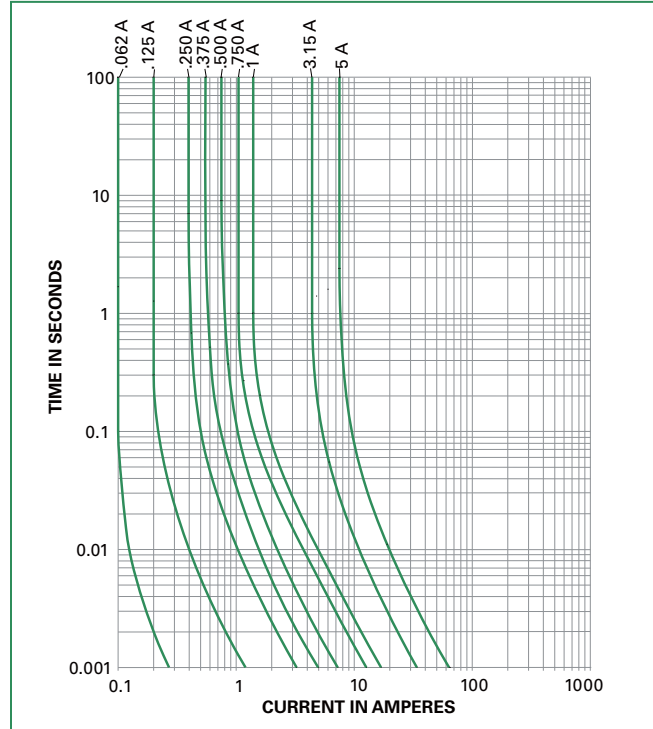

Part Numbering System

0259.062M

SERIES

AMP Code

The dot is positioned before the Packaging Suffix with whole ratings and within the numbering sequence for fractional ratings. Refer to Amp Code column in the Electrical Specifications table.

PACKAGING Code

M = Bulk pack, 1000 pcs
T = Bulk pack, 10 pcs

Example:

1 amp product is
0259**001**.M
(.062 amp product shown).

RoHS 481 Series Alarm Indicating Fuse





Description

481 Series alarm indicating fuses are designed to reduce down time by immediately pinpointing the blown (open) circuit while triggering an LED or audio alarm. This item requires 482 Series mating fuse holder.

All ranges of 481 Series fuses are available as our original design, and the 2-20 amp range is now available as a RoHS compliant option (use the "P" designator when ordering). See the part numbering section of this data sheet for related ordering instructions.

Agency Approvals

Agency	Agency File Number
	E71611
	LR 29862

Electrical Characteristics

% of Ampere Rating	Opening Time
100%	10 Minutes, Minimum
150%	5 Minutes, Maximum



Features

- Color-coded indicator flags indicate ampere rating.
- Clear plastic lens option available for additional safety.
- Body is constructed of black polyphenylene sulfide with UL-94V0 flammability rating.
- Contacts made of bright alloy-plated beryllium copper.

Applications

Ideal for telecommunications and control panel circuits

Electrical Characteristics

Ampere Rating (A)	Amp Code	Max Voltage Rating (V)	Interrupting Rating	Body Color Code	Nominal Cold Resistance (Ohms)	Nominal Melting I ² t (A ² Sec.)	Agency Approvals	
								
0.180*	.180	125 VAC & 125 VDC	450A @ 60 VDC	Yellow	6.25	0.00808	x	x
0.200*	.200			Red/Black	5.70	0.0140	x	x
0.250*	.250			Violet	4.20	0.0356	x	x
0.375*	.375			Gray/White	2.00	0.028	x	x
0.500*	.500			Red	1.52	0.139	x	x
0.650*	.650			Black	1.25	0.278	x	x
0.750*	.750			Brown	.980	0.363	x	x
1.00*	001.			Gray	.665	0.733	x	x
1.33*	1.33			White	.480	1.58	x	x
1.50*	01.5			Yellow/White	.385	2.55	x	x
2.00	002.		Orange	.120	5.29	x	x	
2.50	02.5		Orange/White	.0904	9.46	x	x	
3.00	003.		Blue	.0670	11.2	x	x	
3.50	03.5		Blue/White	.0415	10.5	x	x	
4.00	004.		Brown/White	.0350	15.4	x	x	
5.00	005.		Green	.0285	26.2	x	x	
7.50	07.5		Black/White	.0113	42.8	x	x	
10.0	010.		Red/White	.00840	115.3	x	x	
12.0	012.		Green/Yellow	.00660	222.5	x	x	
15.0	015.		Red/Blue	.00580	294.22	x	x	
20.0**	020.	Green/White	.00394	570.0	x	x		

* 0.180A thru 1.5A items are not available for sale as a RoHS compliant "P" option

**20A Fuseholder must be used. Fuse is keyed to prevent insertion in lower rated holders.

20A Fuseholder is designed to accept all ratings up to 20 amperes.

Product Characteristics

Material	Body: Polyphenylene Sulfide (UL 94VO)
	Terminations: Beryllium Copper/Tin Plated
	Optional Lens: Nylon
Vibration	Per MIL-STD-202F

Operating Temperature	- 55°C to 90°C.
Thermal Shock	Withstands 5 cycles of - 55°C to 125°C
Insulation Resistance (After Opening)	Greater than 10,000 ohms.

Dimensions

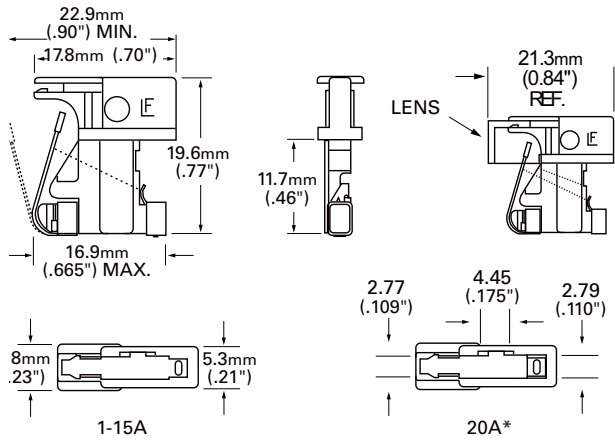

*20A Fuseholder must be used. Fuse is keyed to prevent insertion in lower rated holders. 20A Fuseholder is designed to accept all ratings up to 20 amperes.

Average Time Current Curves

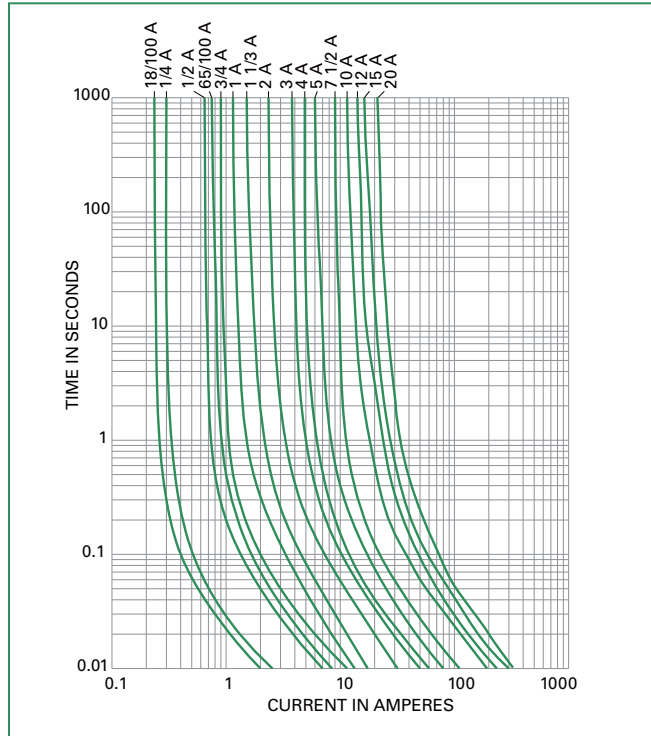

Part Numbering System

0481 .180 H XL P

RoHS ITEM OPTION CODE:
 Blank = Standard design item
 P = RoHS compliant version item
 (available in 2-20 amp range only)

OPTION CODE:
 Blank = Standard
 XL = Protective Lens

QUANTITY CODE:
 V = 5 pack
 H = 100 pack

AMP CODE
 (See Electrical Characteristics Table)

SERIES

RoHS 482 Series Fuseholders

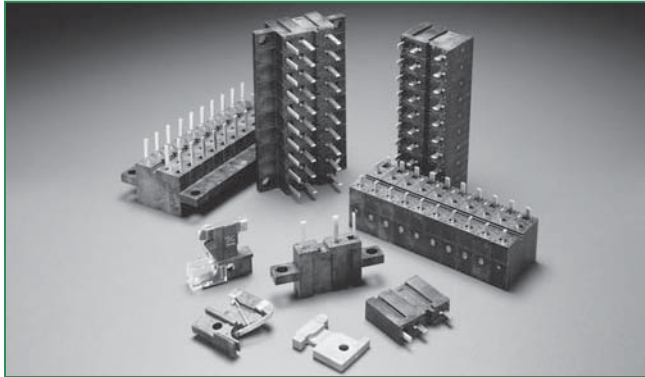

Description

Ideal for telecommunications and control panel circuits, the 482 Series fuseholder series is designed for use with Littelfuse 481 Alarm Indicating Fuses. Each holder is designed to accept other manufacturer's replacement fuses as well.



The fuseholder is available in three versions:

PCB Mount - 15A: Can be soldered directly to a printed circuit board. Rated up to 15 amperes. Available in single pole or gangable up to 20 poles. Fuseholder is keyed to prevent insertion of 20 ampere fuse.

Panel Mount - 20A: Available in a single pole version rated up to 20 amperes. Large leads for wire attachment.

Panel Mount - 15A: 15 ampere gangable version of fuseholder is keyed to prevent insertion of 20 ampere fuse.

Agency Approvals

Agency	Agency File Number
	
	E71611 (20A Panel Mount Only)
	LR 29862

Product Characteristics

482 Fuseholder Series	15A PCB Mount and Panel Mount	20A Panel Mount
Electrical Rating	Rated at 15 amperes up to 125 VAC/VDC	Rated at 20 amperes up to 125 VAC/VDC
Body Material	Thermoplastic (UL 94V-0)	Black Phenolic (UL 94V-0)
Fuse Terminal Material	Tin-plated Beryllium Copper	Tin-plated Copper Alloy
Alarm Terminal Material	Tin-plated Brass	Tin-plated Copper Alloy
Operating Temperature	-55°C to +125°C.	-40°C to +85°C.
Thermal Shock	Withstands 5 cycles of - 55°C to 125°C	Withstands 5 cycles of - 55°C to 125°C
Vibration	Per MIL-STD-202F	Per MIL-STD-202F
Insulation Resistance (After Opening)	Greater than 10,000 ohms.	Greater than 10,000 ohms.

Ordering Information

20A Panel Mount Fuseholder

Type	Holder Length *	20A Panel Mount
1 Pole	6.40mm (25")	0482 2001ZXP

* NOTE: 20 ampere version of 482 Series Panel Mount fuseholders come standard as a single pole unit with flush edges on both sides (no "keys" typical with 15A units). Please refer to the diagrams on the following page for additional information.

15A PCB Mount and Panel Mount Fuseholders

Type	Holder Assembly Length*	15A PCB Mount	15A PCB Mount - Flush	15A Panel Mount	15A Panel Mount - Flush
1 Pole	6.40mm (25")	0482 0001ZXB	0482 0001ZXB	0482 0001ZXP	0482 0001ZXP
2 Pole	12.80mm (.50")	0482 0002ZXB	0482 0002ZXB	0482 0002ZXP	0482 0002ZXP
3 Pole	19.05mm (.75")	0482 0003ZXB	0482 0003ZXB	0482 0003ZXP	0482 0003ZXP
4 Pole	25.04mm (1.0")	0482 0004ZXB	0482 0004ZXB	0482 0004ZXP	0482 0004ZXP
5 Pole	31.75mm (1.25")	0482 0005ZXB	0482 0005ZXB	0482 0005ZXP	0482 0005ZXP
6 Pole	38.10mm (1.50")	0482 0006ZXB	0482 0006ZXB	0482 0006ZXP	0482 0006ZXP
7 Pole	44.45mm (1.75")	0482 0007ZXB	0482 0007ZXB	0482 0007ZXP	0482 0007ZXP
8 Pole	5.80mm (2.00")	0482 0008ZXB	0482 0008ZXB	0482 0008ZXP	0482 0008ZXP
9 Pole	57.15 (2.25")	0482 0009ZXB	0482 0009ZXB	0482 0009ZXP	0482 0009ZXP
10 Pole	63.50mm (2.75")	0482 0010ZXB	0482 0010ZXB	0482 0010ZXP	0482 0010ZXP
11 Pole	69.85mm (2.75")	0482 0011ZXB	0482 0011ZXB	0482 0011ZXP	0482 0011ZXP
12 Pole	76.20mm (3.00")	0482 0012ZXB	0482 0012ZXB	0482 0012ZXP	0482 0012ZXP
13 Pole	82.55mm (3.25")	0482 0013ZXB	0482 0013ZXB	0482 0013ZXP	0482 0013ZXP
14 Pole	88.90mm (3.50")	0482 0014ZXB	0482 0014ZXB	0482 0014ZXP	0482 0014ZXP
15 Pole	95.25mm (3.75")	0482 0015ZXB	0482 0015ZXB	0482 0015ZXP	0482 0015ZXP
16 Pole	101.60mm (4.00")	0482 0016ZXB	0482 0016ZXB	0482 0016ZXP	0482 0016ZXP
17 Pole	107.95mm (4.25")	0482 0017ZXB	0482 0017ZXB	0482 0017ZXP	0482 0017ZXP
18 Pole	114.30mm (4.50")	0482 0018ZXB	0482 0018ZXB	0482 0018ZXP	0482 0018ZXP
19 Pole	120.65mm (4.75")	0482 0019ZXB	0482 0019ZXB	0482 0019ZXP	0482 0019ZXP
20 Pole	127.00mm (5.00")	0482 0020ZXB	0482 0020ZXB	0482 0020ZXP	0482 0020ZXP

* NOTE: 15 ampere gangable version of PCB Mount and Panel Mount fuseholders are keyed to prevent insertion of 20 ampere fuse. Please refer to "A" dimension of diagrams on following page. For additional terminal lengths, please contact Littelfuse.

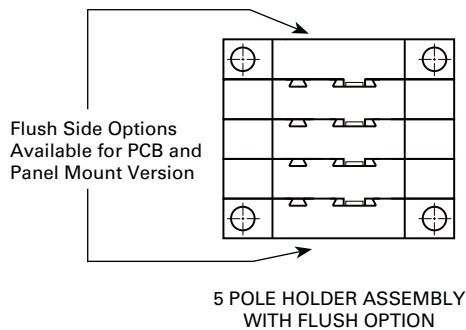

Dimensions

15A PCB Mount Series:

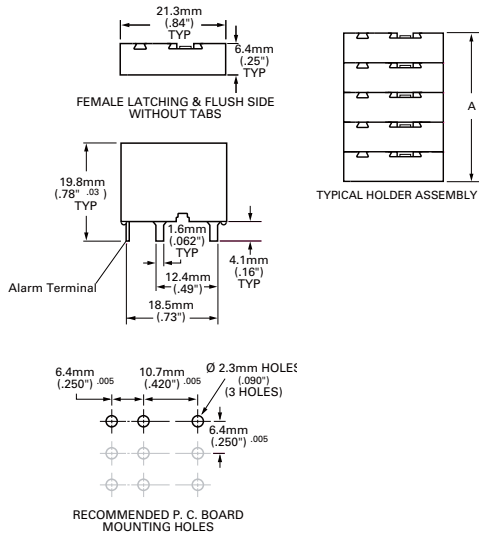

15A Panel Mount Series:

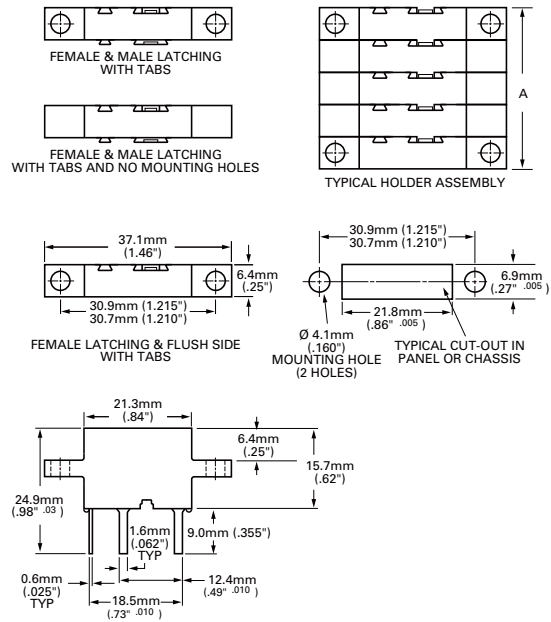

20A Panel Mount Series:

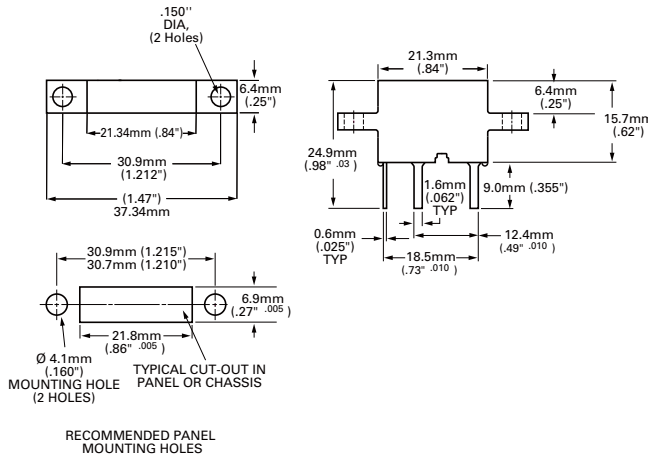

NOTE: The 20 ampere single pole holder is designed to accept all fuse ratings up to 20 amperes.

20 ampere fuseholders should be spaced 12.7mm (0.50) apart when loaded to maximum capacity, center to center to insure proper heat dissipation under normal operation.

Heatsinking may be required for operation in higher ambient temperatures or alternate configurations.



WWW.LITTELFUSE.COM

To assist you with your electronics design and selection processes, Littelfuse also offers:

Comprehensive Online Product Specs on Littelfuse.com—Featuring easy-to-use navigation, search and selection tools, as well as additional product details. You can rely on Littelfuse.com for instant answers and continuously up-to-date information.

Printed Product Catalogs—For offline and off-the-shelf convenience, our printed product catalogs include data sheets, selection tables and tutorials covering all of our core technologies. Contact your Littelfuse product representative or visit www.littelfuse.com/catalogs to check availability.

Circuit Protection Design Guides—Our application design center website, www.littelfuse.com/designcenter offers a wealth of circuit protection guidance to help you select and apply the best circuit protection solution for your application.

As the world's #1 brand in circuit protection Littelfuse offers the broadest and deepest portfolio of circuit protection products and a global network of technical support, backed by more than 80 years of application design expertise. Visit our design support center to access:

- > Reference Designs
- > Application Notes
- > Application Testing
- > SPICE Models
- > Local Technical Support
- > Product Samples
- > Technical Articles
- > Certification Documents
- > Data Sheets



WWW.LITTELFUSE.COM/DESIGNSUPPORT

Littelfuse offers technologies that protect sensitive electronics and their users against electrostatic discharge (ESD), load switching, lightning strikes, overloads, short circuits, power cross, ground faults and other threats.

Overcurrent protection products:

Fuses Littelfuse offers the world's broadest range of fuse types and ratings, including cartridge, leaded, surface mount and thin film designs

PTCs Positive Temperature Coefficient thermistor technology provides resettable current-limiting protection

Overvoltage protection products:

Varistors Littelfuse offers surface mount Multi-layer Varistors (MLVs) and industrial Metal Oxide Varistors (MOVs) to protect against transients

GDTs Gas Discharge Tubes (GDTs) to dissipate voltage through a contained plasma gas

Thyristors Littelfuse's solid state switches control the flow of current in a wide range of appliances, tools and equipment

SIDACTor® Devices Overvoltage protection specifically designed for telecom and datacom requirements

TVS Diodes Silicon transient voltage suppression (TVS) devices

SPA™ Silicon Protection Arrays designed for analog and digital signal line protection

PulseGuard® ESD Suppressors Small, fast-acting Electrostatic Discharge (ESD) suppressors



To request catalogs for the Littelfuse portfolio of circuit protection technologies, please contact your authorized Littelfuse product representative or visit our website at www.littelfuse.com/catalogs